

TONGUE ROOT HARMONY AND VOWEL CONTRAST IN  
NORTHEAST ASIAN LANGUAGES

A Dissertation

Presented to the Faculty of the Graduate School

of Cornell University

In Partial Fulfillment of the Requirements for the Degree of

Doctor of Philosophy

by

Seongyeon Ko

August 2012

© 2012 Seongyeon Ko

# TONGUE ROOT HARMONY AND VOWEL CONTRAST IN NORTHEAST ASIAN LANGUAGES

Seongyeon Ko, Ph. D.

Cornell University 2012

This dissertation investigates the synchrony and diachrony of the vocalism of a variety of Northeast Asian languages, especially Korean, Mongolic, and Tungusic languages, which have traditionally been described as having developed from a palatal system. The dissertation rewrites the vocalic history by demonstrating that the original vowel harmony in these languages was in fact based on an RTR, rather than a palatal, contrast, and provides a formal account for the development of individual vowel systems within the framework of Contrastive Hierarchy (Dresher, 2009).

Following the general and theoretical background in Chapter 1, Chapter 2 begins to explore how the vowel contrasts in the modern Mongolic languages are hierarchically structured. It proceeds to propose an RTR analysis for Old Mongolian (contra Poppe, 1955) based on a combination of arguments from the comparative method, the typology of vowel shifts, and the phonetics of vowel features. Consequently, the palatal system in Kalmyk/Oirat is understood not as a retention but an innovation as a result of an RTR-to-palatal shift, contra Svantesson's (1985) palatal-to-RTR shift hypothesis. Chapter 3 presents an innovative view that Middle Korean had an RTR contrast-based vowel system and that various issues in Korean historical phonology receive better treatment under the contrastive hierarchy approach. Chapter 3 also argues that Ki-Moon Lee's (1964, 1972) Korean vowel shift hypothesis

is untenable, based on the RTR analysis of Old Mongolian presented in Chapter 2. Chapter 4 shows that an RTR-based contrastive hierarchy analysis also holds for the lesser-studied Tungusic languages including Proto-Tungusic. Turning to theoretical issues, Chapter 5 investigates the minimal difference between Mongolic vs. Tungusic /i/ in terms of its transparency/opacity to labial harmony (van der Hulst & Smith, 1988). The contrastive hierarchy approaches to the Mongolic and Tungusic vowel systems in the previous chapters, coupled with a “fusional harmony” approach (Mester, 1986), provide a very simple but elegant solution to the minimal difference between the two languages, allowing us to maintain the Contrastivist Hypothesis (Hall, 2007). Chapter 6 addresses empirical and theoretical implications of the major findings in the main chapters and concludes the thesis.

## BIOGRAPHICAL SKETCH

Seongyeon Ko was born in Jeju, Korea on September 25, 1974. He graduated from Ohyun High School in Jeju and moved to Seoul, Korea, in 1993 to attend Seoul National University, where he majored in Linguistics. He served in the Korean Army from May, 1996 to July, 1998. He received a Bachelor of Arts degree in Linguistics in 2000 and a Master of Arts degree in Linguistics in 2002 with a specialization in phonology. While pursuing a Ph.D. degree there, he participated in various research projects including one dubbed ASK REAL (The Altaic Society of Korea--Researches on the Endangered Altaic languages), which laid the empirical foundation for his Ph.D. research at Cornell University (2005-2012). He will start to teach at Queens College, City University of New York, in Fall 2012, as assistant professor of Korean language and linguistics in the Department of Classics, Middle Eastern, Asian Languages & Cultures.

To my parents, Jongsong Koh and Jungja Kang.

## ACKNOWLEDGMENTS

First of all, I would like to thank the three members of my Special Committee, John Whiman, Draga Zec, and Abby Cohn, for their support, guidance, and patience. I would never have been able to finish my dissertation without the guidance of my advisor, John Whitman, who played a pivotal role in shaping my embryonic ideas into the present thesis with his broad and deep knowledge of East Asian languages and linguistics. I have learned a great deal from him not only as an exceptional advisor, but also as a model linguist (and a model academic in general), a paragon of teaching, and a generous landlord of what I dubbed “the Whitman House.” Draga Zec first served as the designated chair of my Special Committee for the first two years after I arrived at Cornell. Her attentiveness helped me get through the first-year crises such as a feeling of alienation as a shy international student. Since then, she has been constantly involved in, and an integral part of, every aspect of the development of my research agenda. With her keen insight and fountain of knowledge on any topic in phonological theory, she often grasped the point out of my gibberish and guided me to a simpler but better solution to a seemingly raveled skein of complicated problems. Abby Cohn, though she joined my committee only after my A-exam, was the one who encouraged me to keep working on my final squib on Middle Korean submitted for her seminar course. That squib was developed as one of my A-papers, and eventually became Chapter 3 of this dissertation. When I was having difficulty in making progress faced with John’s long-term absence, she was there to play the supervisor’s role as a proxy when I needed it most. Her extensive knowledge on phonology, phonetics, and their interface, coupled with her unmatched enthusiasm, has helped me improve every single page of the final version.

I also thank Michael Wagner and Julie Legate for their willingness to be members of my Special Committee while they were at Cornell. Michael brought to my attention Dresher's theory of contrastive hierarchy and helped me digest it from A to Z. Julie has broadened my research interests to fieldwork-based formal syntax, which surely will frame my post-dissertation research on the morphosyntax of endangered Northeast Asian languages. I am also grateful to other Cornell faculty members Dorit Abusch, John Bowers, Wayles Browne, Molly Diesing, John Hale, Wayne Harbert, Sue Hertz, Sarah Murray, Alan Nussbaum, Mats Rooth, Sam Tilsen, and Michael Weiss, who taught and supported me in various ways.

This dissertation project has its roots in my graduate research in the Linguistics Department at Seoul National University, where I was lucky to have the privilege of taking an active part in a research project called REAL (Researches on Endangered Altaic Languages) under the guidance of Prof. Juwon Kim. I was so deeply inspired by his works on Middle Korean and Tungusic vowel harmony that in many cases I simply fleshed out his original ideas within a more contemporary theoretical framework. I would also like to express my sincere gratitude to Prof. Yangsoo Moon who taught me phonology for the first time when I was an undergraduate student, accepted me into the graduate school, and guided my M.A. thesis. I am also very much indebted to Professors Baegin Seong, Hyunbok Lee, Younhan Kim, Chungmin Lee, Jae-il Kwon, Seungjae Lee, Seungho Nam, Jongho Jun, Hoyoung Lee, Hyopil Shin, and Dongho Ko for their guidance and support throughout my years at SNU.

I thank Elan Dresher, Jerold Edmondson, György Kara, Larry Hyman, Martine Robbeets, J. Marshall Unger, Bert Vaux, and Rachel Walker for their insightful questions, comments, encouragements, and generous sharing of their work. In particular, I am deeply indebted to Elan Dresher for his considerable body of work on contrast, which provides the theoretical foundation of the analyses presented in this



dissertation. I was first inspired by his article on Written Manchu, then more intrigued by a lecture he gave at Cornell, and later personally encouraged in an individual meeting to fully develop my rudimentary ideas on the history of the Korean vowel system.

I would also like to say “bayarlalaa (thank you)” to my “bagshi (teacher)” Tserenchunt Legden and her family, who instructed me in Mongolian language and culture in the Summer of 2010.

My fellow linguists at Cornell have always cheered me up in various ways while I was dissertating: my same-year cohort, Masayuki Gibson, Zhiguo Xie, and Jiwon Yun; my “roomies” in B12, Becky Butler and Peggy Renwick; my dear friends in the P-lab, Christina Bjorndahl, Alison Fisher, Jo Johnson, Esra Kesici, Teresa Galloway, Steven Ikier, Satoshi Ito, and Marie-Josée L’Espérance; and my colleagues in the C-lab, Neil Ashton, Zhong Chen, Anca Cherecheș, Nan Li, and David Lutz. Special thanks to Christina (and Adam) Bjorndahl for stimulating me to become more sociable and sharing all the good memories of hanging out together. Also, thank you to my Cornell “senpay” (先輩 せんぱい), Adam Cooper, Effi Georgala, Andrew Joseph, Hyun Kyung Hwang, Hye-Sook Lee, and Nikola Predolac for their constant support and friendship.

Special thanks go to Andrew Joseph for the time and effort he invested when proofreading my draft. His expertise in Manchu-Tungus and Mongolic languages has helped me significantly improve the clarity, coherence, and consistency in my analyses, arguments, and data.

I also thank my friends from Seoul National University, Eunji Kang, Hijo Kang, Hyun Kyung Hwang, Seunghun Julio Lee, and Sangchul Park for their help in various forms at different stages of the development of this dissertation.

Finally, I would like to express my deepest gratitude to my beloved wife, Jiwon Yun, who is always the most beautiful girl in my world, for her unwavering belief in me and the life-changing gift from her, our son Kenneth Ko.

## TABLE OF CONTENTS

Biographical sketch .....	iii
Dedication.....	iv
Acknowledgments .....	v
Table of contents .....	ix
List of figures .....	xiii
List of tables .....	xiv
Chapter 1. Introduction.....	1
1.1. Objectives .....	1
1.2. Languages .....	3
1.3. Tongue root harmony.....	7
1.3.1. Vowel harmony .....	7
1.3.2. Historical sketch of the study of tongue root contrast.....	12
1.3.3. ATR vs. RTR: distinct features or two sides of the same coin?.....	20
1.4. Theoretical framework.....	24
1.4.1. Modified contrastive specification .....	24
1.4.2. Inuit vowel systems (Compton & Drescher, 2011).....	27
1.4.3. A formal model of contrastive hierarchy changes.....	31
1.4.4. The Contrastivist Hypothesis vs. Visibility Theory .....	37
1.4.5. Articulator features.....	39
1.5. Structure of the dissertation .....	43
Chapter 2. Mongolic languages .....	45
2.1. Introduction.....	45
2.1.1. The Mongolic languages .....	46
2.1.2. Structure of Chapter 2 .....	52

2.2. Vowel contrast in the Mongolic languages.....	53
2.2.1. Type I: Khalkha type languages.....	54
2.2.2. Type II: Monguor type languages.....	72
2.2.3. Type III: Dagur type languages.....	92
2.2.4. Type IV: Oirat type languages.....	119
2.2.5. Interim summary.....	135
2.3. Historical development of Mongolic vowel systems.....	136
2.3.1. The Mongolic Vowel Shifts hypothesis.....	139
2.3.2. An RTR analysis of Old Mongolian.....	143
2.3.3. The development of the Mongolic vowel systems.....	161
2.4. Implication on the intra-Mongolic taxonomy.....	167
Chapter 3. Korean.....	169
3.1. Introduction.....	169
3.1.1. The Korean language.....	169
3.1.2. Structure of Chapter 3.....	171
3.2. Vowel contrast in Middle Korean.....	172
3.2.1. Vowel system and vowel harmony in Middle Korean.....	173
3.2.2. A contrastivist analysis of the Middle Korean vowel system.....	182
3.2.3. Consequences of the contrastive hierarchy analysis.....	193
3.3. Vowel contrast in Early Modern Korean.....	201
3.3.1. Vowel system in Early Modern Korean.....	201
3.3.2. Change of contrastive hierarchy and the two-step merger of /ʌ/.....	202
3.3.3. Evidence for the three-height distinction and the labial contrast.....	210
3.3.4. Interim summary.....	217
3.4. Vowel contrast in Contemporary Korean.....	218
3.4.1. Overview.....	218

3.4.2. Contrastive hierarchy approach to the two major directions.....	220
3.4.3. Central Korean .....	222
3.4.4. Jeju (Cheju) Korean .....	225
3.5. The end of the Korean vowel shift controversy .....	229
3.5.1. The Korean Vowel Shift hypothesis .....	229
3.5.2. Old Mongolian: an RTR analysis .....	236
3.5.3. Mongolian loanwords revisited .....	238
3.5.4. Summary .....	241
3.6. Conclusion .....	241
Chapter 4. Tungusic language .....	243
4.1. Introduction.....	243
4.1.1. The Tungusic languages.....	243
4.1.2. Structure of Chapter 4 .....	245
4.2. Vowel contrast in Tungusic languages .....	246
4.2.1. Southwest Tungusic languages (Written/Spoken Manchu and Sibe).....	246
4.2.2. Southeast Tungusic languages (Udihe, Oroch, Ulchi, Orok, Nanai).....	274
4.2.3. Northern Tungusic languages.....	316
4.3. Historical development of Tungusic vowel systems.....	339
Chapter 5. Tungusic vs. Mongolic labial harmony .....	342
5.1. Introduction.....	342
5.2. Previous Analysis: van der Hulst & Smith (1988).....	344
5.3. Framework: Fusional Harmony (Mester, 1986) .....	348
5.4. Analysis .....	350
5.5. Alternatives .....	359
5.5.1. Kaun (1995).....	360
5.5.2. Nevins (2010).....	363

5.6. Conclusion .....	375
Chapter 6. Conclusion .....	376
6.1. The original vowel contrast in Altaic languages.....	376
6.2. Contrast-driven typology of vowel systems in Altaic Languages .....	379
6.2.1. Inventory-driven typology of Altaic vowels .....	379
6.2.2. Contrast-driven typology of Altaic vowels .....	385
6.3. Towards a theory of contrastive hierarchy changes.....	393
6.4. Future study .....	394
Appendix .....	396
Bibliography .....	398

## LIST OF FIGURES

Figure 1. Distribution of language families in Northeast Asia ca. 1800 (Whitman, 2011, p. 150).....	3
Figure 2. The distribution of “Altaic” languages (J. Kim, Kwon, Ko, Kim, & Jeon, 2008).....	5
Figure 3. Tracings from single frames in a cineradiology film showing the tongue positions in the two sets of Igbo vowels (Ladefoged, 1964, p. 38).....	13
Figure 4. Map of the modern Mongolic languages (Svantesson, Tsendina, Karlsson, & Franzén, 2005).....	46
Figure 5. Comparison between Jeju vowel systems at two time frames (T. Cho et al., 2000). The data of H.-K. Kim (1980) were collected in 1969. ....	227
Figure 6. Spectrogram of the Oroch word /kolia/ [qʊʎja:] ‘worm.’ .....	281
Figure 7. Formant chart of Najkhin Nanai vowels (D. Ko & Yurn, 2011, p. 21). Vertical axis: F1, horizontal axis: F2-F1.....	308
Figure 8. Short oral vowels by frequency in P-base (represented by the area) taken from <a href="http://aix1.uottawa.ca/~jmielke/pbase/index.html">http://aix1.uottawa.ca/~jmielke/pbase/index.html</a> .....	382

## LIST OF TABLES

Table 1. Endangered Altaic languages (based on Janhunen & Salminen, 1993; Moseley, 2010) .....	6
Table 2. Number of vowel qualities (Maddieson, 1984, p. 127) .....	380
Table 3. Intra-Altaic typology of vowel qualities .....	383



# CHAPTER ONE

## INTRODUCTION

### **1.1. Objectives**

This study is a thorough investigation of the vowel harmony systems of Northeast Asian languages, especially Korean, Mongolic, and Tungusic languages, from both synchronic and diachronic points of view. It carefully examines the vowel inventories and vowel patterns of modern varieties of these languages and attempts to answer the following questions:

Q1: Was RTR (Retracted Tongue Root) the original contrast in Korean, Mongolic, and Tungusic languages?

Q2: How have these original vowel systems evolved through time? How can we explain the shift from an RTR to a palatal harmony as found, for example, in some varieties of Mongolic?

Besides the above thread running through the dissertation, this study also aims to touch upon various empirical and theoretical issues relevant to the vowel phonology of Northeast Asian languages. An example of this sort is my analysis of transparency and opacity in vowel harmony. In so doing, this dissertation is intended to serve as an overview of and contribution to theoretical treatments of the synchronic vocalism as well as the vocalic history of these languages.

This introductory chapter is structured as follows. Section 1.2 provides a general overview of the target languages. Section 1.3 introduces four major types of vowel

harmony this dissertation covers to varying degrees—palatal, labial, height, and tongue root harmony—and presents a historical sketch of the previous researches on the phonetics and phonology of the tongue root contrast, mainly from the realm of the West African linguistics. Section 1.4 lays out the theoretical framework of the dissertation including a new model of phonological change in terms of feature hierarchy. Finally, Section 1.5 gives a foretaste of the dissertation with a chapter-by-chapter overview.

## 1.2. Languages

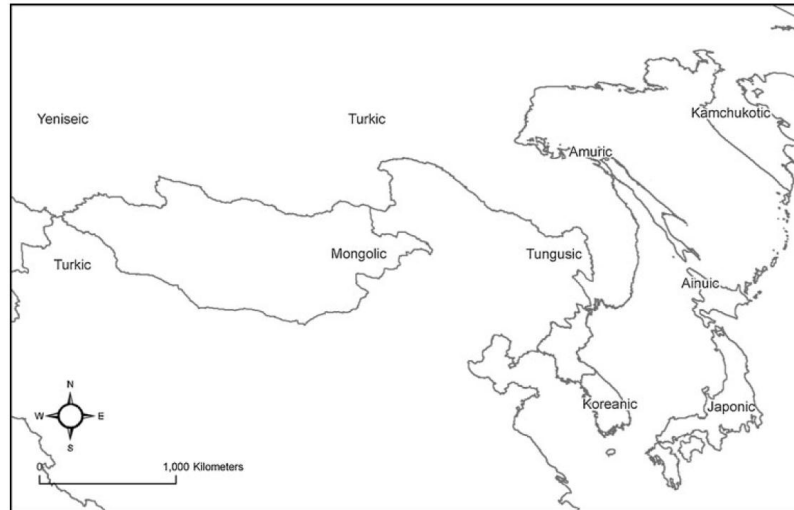

Figure 1. Distribution of language families in Northeast Asia ca. 1800 (Whitman, 2011, p. 150)

The areal focus of this research is on Northeast Asia, by which I refer to the vast area spanning Japan, the Korean Peninsula, Northwest/North/Northeast China, and the Russian Far East stretching from Lake Baikal in Central Siberia to the Kamchatka Peninsula. As a linguistic area, it comprises the following ten language families (Janhunen, 1998; Whitman, 2011), excluding Sino-Tibetan languages (Thurgood & LaPolla, 2003):

(1) Language family and location (Whitman, 2011, p. 150)

<u>Language</u>	<u>Region</u>
Ainuic	Hokkaido, Sakhalin
Amuric (Nivkh/Gilyak)	Amur estuary, Sakhalin
Japonic	Japanese archipelago
Kamchukotic	Kamchatka

Koreanic	Korean peninsula
Mongolic	Mongolia, China, Russia
Tungusic	China, Russia
Turkic	Siberia, Central Asia
Yeniseic	Yenisei basin
Yukaghiric	Sakha Republic

Roughly speaking, the above ten languages can be divided into two groups: the so-called “Paleosiberian” and “Altaic” language groups. Ainuic, Amuric, Kamchukotic, Yeniseic, and Yukaghiric belong to the first group (Comrie, 1981; Vajda, 2009) and Japonic, Koreanic, Mongolic, Tungusic, and Turkic belong to the second group. This thesis focuses on the second group, especially Koreanic, Mongolic, and Tungusic languages, which have (or once had) a vowel harmony based on tongue root contrast. Turkic languages, another major member of the “Altaic” language group, are widely understood to have a different type of vowel harmony, namely, palatal harmony. They will not be extensively investigated *per se*, but their vowel systems and harmony patterns will be introduced where a comparison is necessary. Japonic (Japanese-Ryukyuan) languages, on the contrary, will be ignored simply because there is no clear evidence of the existence of vowel harmony in the history of the Japanese language.

Note that, although I use the term “Altaic” throughout the thesis, it is not to be understood as suggesting a genetic relationship among them.<sup>1</sup> Rather, I will use it as a

---

<sup>1</sup> See Ramstedt (1952), Poppe (1960a, 1965), Miller (1971), Starostin et al. (2003), among others for various versions of Altaic hypothesis and Doerfer (1963), Georg et al. (1999), Vovin (2005) among others for criticisms.

loose umbrella term to refer to non-Sino-Tibetan, non-Paleosiberian Northeast Asian languages.

The following map roughly shows the locations of the so-called “micro-Altalic” languages:



Figure 2. The distribution of “Altalic” languages (J. Kim et al., 2011)

Tungusic (11)	Mongolic (10)	Turkic (34)
1. Ewen	12. Dagur	22. Chuvash
2. Ewenki (Oroqen)	13. Monguor	23. Khalaj
3. Solon	14. Bonan	24. Turkish
4. Negidal	15. Kangjia	25. Gagauz
5. Nanai	16. Dongxiang	26. Azerbaijani
6. Uilta (Orok)	17. Shira Yugur	27. Turkmen
7. Ulchi	18. Buriat	28. Khorasan Turkish
8. Udihe (Udege)	19. Mongolian	29. Qashqa'i
9. Oroch	20. Kalmyk/Oirat	30. Afshar
10. Manchu	21. Moghol	31. Aynallu
11. Sibe		32. Salar
		33. Uyghur
		34. Uzbek
		35. Crimean Tatar
		36. Urum
		37. Karaim
		38. Karachai-Balkar
		39. Kumyk
		40. Tatar
		41. Bashkir
		42. Kazakh
		43. Karakalpak
		44. Nogai
		45. Kirghiz
		46. Altai
		47. Khakas
		48. Shor
		49. Chulym Turkish
		50. Tuvan
		51. Tofa
		52. Yakut
		53. Dolgan
		54. West Yugur
		55. Fuyu Kirghiz

Note that there are certain “Altalic” languages that are spoken outside the Northeast Asian linguistic area. These are mostly Turkic languages, but also include certain Mongolic languages such as Kalmyk (No. 20) spoken in the Republic of Kalmykia (a

federal subject of Russia that abuts the Caspian Sea) and Moghol (No. 21) spoken in the region of Herat, Afghanistan.

Most of these “Altaic” languages are endangered and underdocumented. In particular, they are relatively understudied within the general linguistic framework and, what is worse, descriptions that are available often includes misinformed analyses.

The following table shows a recent assessment of the degree of endangerment:

	Tungusic	Mongolic	Turkic
extinct (since the 1950s)	Arman Ewen, Ongkor Solon, Udihe (Kyakala)		Tuvan (Soyot)
critically endangered	Manchu, Negidal, Oroch, Oroqen, Ulch, Udihe, Uilta, Nanai (Hezhen, Kili, Kilen)	Manchurian Ö löt (Oirat), Shira Yugur, Kangjia	Chulym Tatar, Tofa, Manchurian Kirgiz, Saryg Yugur, Uyghur Uryangkhay (almost extinct)
severely endangered	Ewen, Ewenki, Nanai, Sibe	Western Buriat, Mongghul	Baraba Tatar, Altai Uryangkhay, Khövsgöl Uryangkhay, Tsaatan (=Dukha), Northern Altai, Teleut, Shor, Ili Turk, Crimean Tatar, Karaim
definitely endangered	Solon	Khamnigan Mongol, Dagur, Kalmyk/Oirat, Mangghuer, Bonan, Ordos	Dolgan, Khakas, Siberian Tatar, Southern Altai, Nogay,
vulnerable		Santa, Eastern Buriat	Bashkir, Tuvan, Yakut, Khorasani Turkish, Salar, Kумыk, Chuvash, Karachai-Balkar

Table 1. Endangered Altaic languages (based on Janhunen & Salminen, 1993; Moseley, 2010)

### 1.3. Tongue root harmony

#### 1.3.1. Vowel harmony

Vowel harmony is a relatively well-known phonological phenomenon. (See Archangeli & Pulleyblank, 2007; Rose & Walker, 2011; van der Hulst & van de Weijer, 1995, for an overview.) Its various types are found in diverse languages dispersed all over the world, but its nature is not yet fully understood. Vowel harmony as a general term can be roughly defined as a phenomenon whereby vowels within a domain agree with each other in terms of one or more features (Krämer, 2003, p. 3). Although this definition does not satisfactorily define vowel harmony as a distinct phonological process with respect to other assimilatory processes such as metaphony and umlaut (see S. R. Anderson, 1980; Archangeli & Pulleyblank, 2007, for further discussion of the issue), it works here as a rough statement on the basic characteristic of the phonological phenomenon that will be dealt with in this thesis.

Among the various types of vowel harmony (with various names assigned to each) that have been proposed in the literature, I identify the following four types as the most frequently attested ones:

- |     |                     |  |
|-----|---------------------|--|
| (2) | Vowel harmony       | Harmonic feature                                     |
| a.  | Palatal harmony     | [back] or [front]                                    |
| b.  | Labial harmony      | [labial (round)]                                     |
| c.  | Height harmony      | [high] or [low]                                      |
| d.  | Tongue root harmony | [Advanced Tongue Root]<br>or [Retracted Tongue Root] |

### 1.3.1.1. Palatal harmony

Palatal harmony, also called backness or vertical harmony, can be found most extensively in Uralic languages (e.g., Finnish and Hungarian) as well as Altaic languages (e.g., Turkish and, arguably, Mongolic). It requires all vowels within a word to be exclusively front or back. A representative example is found in Turkish which has the following symmetrical 8-vowel system with four front vowels /i, ü, e, ö/ and four back vowels /ı, u, a, o/:

#### (3) Turkish vowel system

	front		back	
	unround	round	unround	round
high	i	ü	ı	u
low	e	ö	a	o

Suffix vowels must agree in backness with stem vowels:

#### (4) Turkish palatal harmony (Clements & Sezer, 1982, p. 216)

Nom.Sg	Gen.Sg	Nom.Pl	Gen.Pl	Gloss
ip	ip-in	ip-ler	ip-ler-in	‘rope’
kız	kız-in	kız-lar	kız-lar-in	‘girl’
yüz	yüz-ün	yüz-ler	yüz-ler-in	‘face’
pul	pul-un	pul-lar	pul-lar-in	‘stamp’
el	el-in	el-ler	el-ler-in	‘hand’
sap	sap-in	sap-lar	sap-lar-in	‘stalk’
köy	köy-ün	köy-ler	köy-ler-in	‘village’
son	son-un	son-lar	son-lar-in	‘end’



### 1.3.1.2. Labial harmony

Labial harmony, or rounding harmony, is also widespread in Uralic and Altaic languages. Typically, it seems to be superimposed on another type of harmony. In the Turkish vowel harmony example given in (4) above, the vowel in the genitive singular suffix must agree with the root vowel in roundness as well as in backness: e.g., *ip-in* ‘rope-Gen.Sg’ vs. *yüz-ün* ‘face-Gen.Sg.’

### 1.3.1.3. Height harmony

Height harmony has been found predominantly in Bantu languages, but is also found in other languages such as Buchan Scots (Paster, 2004) as shown below. However, height harmony may be reanalyzed as tongue root harmony in many cases (see van der Hulst & van de Weijer, 1995).

(5) Buchan Scots vowel inventory (Paster, 2004, p. 361)

i	u	high	
<hr/>			
e	o	non-high	
ɛ	ɜ	ʌ	ɔ
a			

(6) Buchan Scots height harmony: a diminutive suffix {-i} (Paster, 2004, p. 365)<sup>2</sup>

a. high vowel stems

mil-i    ‘mealie’    dir-i    ‘dearie’    kuθ-i    ‘couthy’

---

<sup>2</sup> According to Paster (p. 354, fn. 4), *Buckie* is a place name; *gamie* means ‘gamekeeper’; *postie* means ‘postman.’

bik-i	‘beakie’	bɪf-i	‘beachie’	hus-i	‘housie’
bin-i	‘beanie’	ɹil-i	‘wheelie’	snut-i	‘snooty’

b. non-high vowel stems

gem-e	‘gamie’	hɜl-e	‘hilly’	got-e	‘goatie’
her-e	‘hairy’	hɹt-e	‘hurtie’	post-e	‘postie’
nel-e	‘nailie’	bɹk-e	‘Buckie’	mom-e	‘mommy’
hel-e	‘hailie’	bɹf-e	‘batchie’	tost-e	‘toasty’
nɛs-e	‘Nessie’	man-e	‘mannie’	sɔs-e	‘saucy’
mɛs-e	‘messy’	las-e	‘lassie’	rɔk-e	‘rocky’

### 1.3.1.4. Tongue root harmony

Tongue root harmony, also rather inadequately called tenseness harmony, horizontal harmony, relative height harmony, and cross-height harmony in the literature, is based on the opposition between the advanced vs. retracted position of the tongue root.

A well-known, or arguably the first known example of a canonical tongue root harmony system (cf. Cenggeltei, 1959) is Igbo, a Niger-Congo language spoken in Nigeria (Ladefoged, 1964). As shown in (7), the eight simple vowels in Igbo fall into two distinct sets of four vowels, Set 1 /i, u, ɛ, o/ and Set 2 /e, ɔ, a, ɔ/, which cannot be mixed in a word in general.

(7) Igbo vowels (Ladefoged, 1964, p. 37).

Set 1		Combined sets		Set 2	
i	u	i	u		
		e	ɔ	e	ɔ
ɛ	o	ɛ	o		
		a	ɔ	a	ɔ

All vowels must agree for the value of the tongue root feature. That is, all vowels must be either [+ATR] as in the left-hand column or [-ATR] as in the right-hand column (Archangeli & Pulleyblank, 1994, p. 2).

- | (8)    Advanced tongue root: [+ATR] | Retracted tongue root: [-ATR]  |
|-------------------------------------|--------------------------------|
| a.    ó-[rì]-rì    ‘he ate’         | e.    ó-[pè]-rè    ‘he carved’ |
| b.    ó-[mè]-rè    ‘he did’         | f.    ó-[sà]-rà    ‘he washed’ |
| c.    ó-[zò]-rò    ‘he did’         | g.    ó-[dò]-rò    ‘he pulled’ |
| d.    ó-[gbù]-rù    ‘he killed’     | h.    ó-[pò]-rò    ‘he bought’ |

The ATR verb roots in (8)a-(8)d take the advanced variants of the prefix ([o]) and the suffix ([ri/rɛ/ro/ru]), whereas the non-ATR verb roots in (8)e-(8)h take retracted variants of the prefix ([ɔ]) and the suffix ([re/ra/rɔ/rɔ]) (Archangeli & Pulleyblank, 1994, p. 2).

Tongue root harmony was once believed by western linguists to exist exclusively in African languages, i.e., Niger-Congo and Nilo-Saharan. For example, Stewart (1967, p. 14) described it as “a type of vowel harmony which is apparently found nowhere outside Africa.” Fulop et al. (1998, pp. 80–81) also stated that it was “largely restricted to the Niger-Congo and Nilo-Saharan language families of Africa.” However, it is well-known that a tongue root contrast also exists in languages in the “Horn of Africa,” e.g., the Afro-Asiatic language Somali (B. L. Hall et al., 1974) as well as outside the African continent, e.g., in the Kamchukotic language Chukchi (or Chukchee) (Kenstowicz, 1979), the Sahaptian language Nez Perce (B. L. Hall & Hall,

1980), and the Salishan language Coeur d'Alene (Doak, 1992; Johnson, 1975), aside from Altaic languages.<sup>3</sup>

It may not be well-known that tongue root harmony patterns in many Altaic languages, especially in Mongolic and Tungusic languages, have long been recognized since the 1950s by some Russian and Mongolian scholars and that a feature comparable to [Retracted Tongue Root], “舌根後縮” (= tongue-root-back-contraction), has been independently proposed by Cenggeltei (1959, 1963). See Novikova (1960), Ard (1981, 1984), Hayata (1980), Hattori (1982), J. Kim (1989, 1993), Li (1996), and Zhang (1996) for Tungusic tongue root vowel harmony and Cenggeltei (1959, 1963), Svantesson (1985), and Svantesson et al. (2005) and references therein for Mongolic tongue root vowel harmony. Middle Korean vowel harmony is also believed to be tongue root-based (Park 1983, J. Kim 1988, 1993, J.-K. Kim 2000, Park & Kwon 2009, among others). These tongue root systems in Northeast Asia will be described in detail in Chapters 2, 3, and 4.

### *1.3.2. Historical sketch of the study of tongue root contrast*

Since Stewart (1967) proposed the feature [ATR] (“root-advanced” in his terminology) for the vowel harmony in Akan (a Niger-Congo language spoken in Ghana), linguists have attempted to develop the technical methodology to reveal the phonetics of the proposed tongue root feature. This section reviews the major findings in the previous instrumental studies of tongue root contrast. These can be divided roughly into two types: articulatory and acoustic studies.

---

<sup>3</sup> See Casali (2008, p. 505) for a more extensive list of languages that have been analyzed as having ATR or ATR-like harmony.

### 1.3.2.1. Articulatory studies

#### 1.3.2.1.1. Cineradiography (X-ray tracings)

In earlier studies, the articulatory mechanism of the tongue root contrast was investigated by means of X-ray photography. First, Ladefoged's (1964) X-ray tracings of Igbo vowels showed that the primary difference between the two vowel sets in Igbo is the advancement vs. retraction of the *body* of the tongue as shown in the following figure (pp. 39-40).

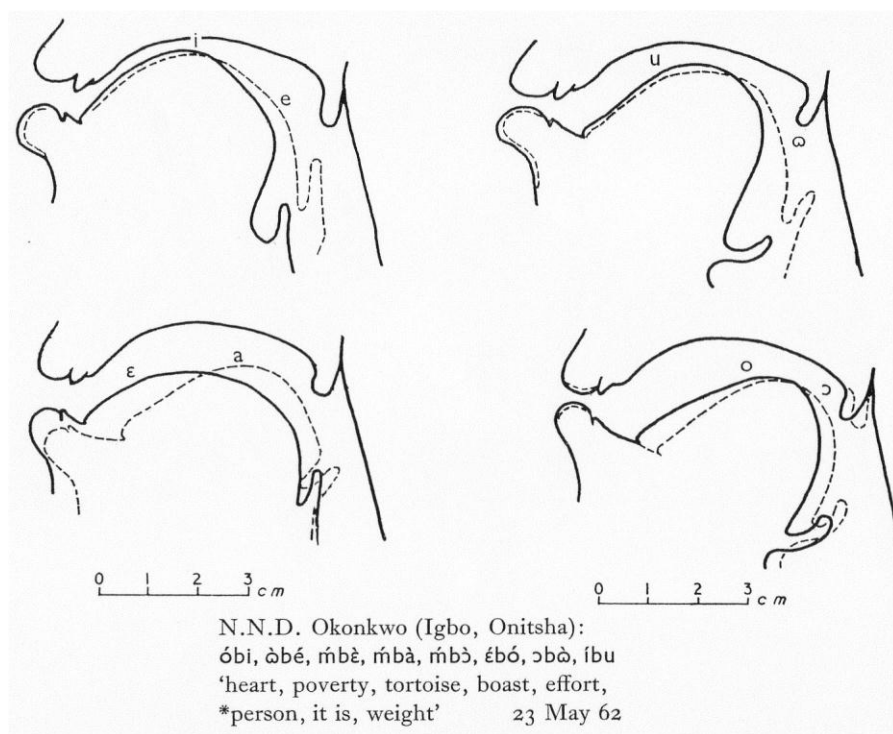

Figure 3. Tracings from single frames in a cineradiology film showing the tongue positions in the two sets of Igbo vowels (Ladefoged, 1964, p. 38)

Stewart (1967) reinterpreted Ladefoged's tongue *body* advancement/retraction as the tongue *root* advancement/retraction based on the chin lowering observed in Akan and on Pike's (1947) description of tongue root advancement. He also pointed out that the

tongue height difference between the harmonic pairs is an epiphenomenon resulting from the difference in tongue root configuration. This view was supported by Halle and Stevens (1969) who acknowledged that the feature Advanced Tongue Root is better than the ill-defined *Covered* proposed by Chomsky and Halle (1968).<sup>4</sup> Lindau (1974, 1979) and Jacobson (1978, 1980) further utilized X-ray studies to investigate the articulatory mechanism of the tongue root contrast. Lindau found that the primary gesture for the [+ATR] vowels in Akan involves a change in the size of the pharyngeal cavity accomplished by a lowered larynx as well as an advanced tongue root. Similarly, Jacobson (1980) reports pharyngeal cavity expansion for the [+ATR] vowels in Nilo-Saharan languages (DhoLuo of Kenya, and Shilluk and Dinka in Sudan), although the expansion is not uniformly achieved across the three languages. Overall, now it seems that there is a general concensus: advanced vowels have a larger pharyngeal cavity whereas retracted ones have a smaller pharyngeal cavity (Guion, Post, & Payne, 2004, p. 522).

Some Altaic languages have also been investigated using cineradiography: Cenggeltei and Sinedke (1959), Buraev (1959), and Novikova (1960). Cenggeltei and Sinedke (1959) provide X-ray tracings of vowels in Mongolian showing that the tongue body is more retracted in one set of vowels than in the other set. Buraev (1959), based on her X-ray tracings, rejects a palatal analysis of the Buriat (Mongolic) harmonic vowel contrast. She characterizes the so-called “soft” vowels as involving “raising of the central part of the tongue blade” (Svantesson, Tsendina, Karlsson, & Franzén, 2005, p. 220). Möömöö (1977, pp. 56–57, as cited in Svantesson et al. 2005)

---

<sup>4</sup> Halle & Stevens (1969) further argue that Advanced Tongue Root can be applied to distinguish the so-called tense and lax vowels in English and other Germanic languages. However, this view has been criticized. See Stewart (1967, pp. 200–2), Ladefoged & Maddieson (1996, pp. 302–6 and references therein), and Tiede (1996) for the differences between tongue root contrast and tense vs. lax contrast.

also reports based on “his unpublished X-ray pictures” that [u] and [o] (his *ü* and *ö*) have a wider pharynx cavity than [ʊ] and [ɔ] (his *u* and *ɔ*), although the position of the tongue blade is approximately the same for the harmonic vowel pairs. He also notes a greater tension in the tongue muscles for [ʊ] and [ɔ] than for [u] and [o] (Svantesson et al., 2005, p. 8). Novikova’s (1960) X-ray images of the Ola dialect of Ewen (Northern Tungusic) show that in the “pharyngealized vowels” (Ladefoged & Maddieson, 1996, pp. 306–310) the size of the pharyngeal cavity decreases as a result of pharyngeal passage narrowing and larynx raising triggered by tongue root retraction. However, as pointed out by Aralova and Grawunder (2011), the settings of Novikova’s experiment are not clearly described. More crucially, it is noticed in Ladefoged and Maddieson (1996) that all vowels in Novikova’s X-ray images and tracings have a lowered velum which means, rather incredibly, that they are all nasalized vowels. This complicates the interpretation of Novikova’s X-rays.

#### 1.3.2.1.2. *MRI*

In addition to the sagittal expansion of the pharyngeal cavity reported in previous X-ray studies, Tiede’s (1996) magnetic resonance imaging (MRI) data for Akan vowels show lateral expansion of the pharyngeal cavity in ATR vowels. Tiede’s articulatory data also show that the ATR contrast in Akan is distinct from the English tense vs. lax contrast.

#### 1.3.2.1.3. *Electroglottography*

Guion et al. (2004) investigated EGG waveforms obtained from one speaker of the Maa language (a Nilo-Saharan language) and calculated the closure quotient (CQ), the ratio of the contact/closure portion to the total duration of the vibratory cycle, which may be associated with the phonatory difference between the [+ATR] and [-ATR]

vowels. They found that [+ATR] vowels in general had smaller CQ values than [-ATR] vowels, which indicates that [+ATR] vowels may be produced with a less constricted glottis and thus more lax or breathy phonation than [-ATR] vowels (pp. 528-9, 534-5).

#### 1.3.2.1.4. *(Transnasal) endoscopy*

Recently, Edmondson & Esling's (2006, pp. 175–9) transnasal endoscopic (or laryngoscopic) study shows that the tongue root contrast between the two vowel sets in Somali (an Afro-Asiatic language) and Kabiye (a Niger-Congo language) involves different laryngeal valve settings. For example, the contrast between “non-constricted” vowels /i e æ ö ʊ/ (traditionally described as [+ATR] vowels) vs. “constricted” vowels /ɪ ɛ ʌ ɔ u/ ([-ATR] vowels) in Somali is characterized as a difference in arytenoid-epiglottal aperture. Interestingly, in Kabiye, it is the [-ATR] vowels which are articulated with a marked constriction formed by the aryepiglottic folds and epiglottis.

#### 1.3.2.1.5. *Ultrasound imaging*

More recently, ultrasound imaging has been used as a harmless, non-invasive way to produce images of the tongue root position (Hudu, 2010; Hudu, Miller, & Pulleyblank, 2009). Based on a hypothesis which assumes a “direct mapping” between articulatory gestures (the tongue root position) and phonological features (the dominance of the [ATR] or [RTR] feature), Hudu et al. (2009) identify the relative advancement of the tongue root for the [+ATR] vowels in Dagbani (a Niger-Congo language of Ghana) compared with the inter-speech posture (ISP). This line of research involving ultrasound technology might be fruitful in finding direct phonetic evidence for the putative gestural difference between the [ATR] and [RTR] features, although this possibility is not tested in this thesis.



To the best of my knowledge, there has been no MRI-, electroglottography-, endoscopy-, or ultrasound-based researches conducted on Altaic languages.

### **1.3.2.2. Acoustic studies**

#### *1.3.2.2.1. Formant frequencies: F1, F2, F3*

The first two formants have been extensively used in phonetics to characterize vowels. There are widely accepted correlations between F1/F2 and vowel height/frontness. The F1-height correlation is negative: the higher the vowel, the lower its F1 frequency. The F2-backness correlation is positive: the fronter the vowel, the higher its F2 frequency. However, F1 and F2 are also affected by other factors such as lip rounding and pharyngeal cavity expansion.

In African languages, it has been pointed out that F1 is the most reliable acoustic cue for the [ATR] feature in e.g., Degema (Niger-Congo, Fulop et al., 1998), Maa (Nilo-Saharan, Guion et al., 2004), Akan (Niger-Congo, Hess, 1992), and Yoruba (Niger-Congo, Przedziecki, 2005). [+ATR] vowels have a lower F1 than their [-ATR] counterparts very consistently. This has the effect that [+ATR] vowels appear to be raised in the acoustic space (Ladefoged & Maddieson, 1996, p. 305), although the lower F1 frequency of [+ATR] vowels is better associated with the pharyngeal cavity expansion rather than the actual tongue body raising, as the aforementioned articulatory studies suggest.

By contrast, F2 does not show a consistent effect on the contrast. In many languages, front [+ATR] vowels have higher F2 values than their front [-ATR] counterparts, while back vowels show the opposite pattern. This indicates that [+ATR] vowels are more “peripheral” than [-ATR] vowels in general. However, this F2 effect is not very consistent across vowel pairs or across languages (Guion et al., 2004; Jakobson, 1980). In other languages, F2 does not always differentiate the two series of

vowels. For example, in Degema, the F2 difference was statistically significant only in the /e/-/ɛ/, /i/-/ɪ/, and /o/-/ɔ/ pairs, but not in the /ə/-/a/ and /u/-/ʊ/ pairs (Fulop et al., 1998).

In addition to F1 and F2, the lowering of F3 has also been noticed as a possible acoustic cue for “pharyngealized” as opposed to plain vowels in Caucasian languages (Catford, 1994, p. 59). Note that Ladefoged and Maddieson (1996, pp. 306–310) relates this vowel contrast in Caucasian to that in Ewen as described by Novikova (1960).

Even though formant frequencies (F1 and F2 in particular) work as effective cues *within* pairs, they may fail to differentiate vowels *across* pairs. For instance, the high [-ATR] vowel /i/ was not always separated from the mid [+ATR] vowel /e/ in terms of F1 and F2 frequencies depending on speakers (Maa, Guion et al., 2004; Akan, Hess, 1992). This suggests that there might be acoustic cues other than formant frequencies. I discuss some of these below.

#### 1.3.2.2.2. *Bandwidth*

The bandwidth of F1 (B1) is another possible acoustic cue. The expectation is that [+ATR] vowels have narrower B1 than [-ATR] vowels. B1 has been investigated in Akan (Hess, 1992), Yoruba (Przedziecki, 2005), and in a number of other Niger-Congo languages including LuBwisi and Ifè (Starwalt, 2008). However, except for the Akan case investigated in Hess (1992), the reported correlation between B1 and ATR contrast is not as robust as that between F1 and ATR contrast.

#### 1.3.2.2.3. *Spectral slope*

Spectral tilt (or spectral flatness) has been measured in various forms such as H1-H2, H1-A2, H1-A3, and H1-A3, with the assumption that [+ATR] vowels have less energy

at higher frequencies than [+ATR] vowels.<sup>5</sup> More recently, the “normalized A1-A2” was first proposed as a measure of the spectral tilt in Degema (Fulop et al., 1998) and has also been applied to Maa (Guion et al., 2004). The results showed that [+ATR] vowels have higher values than their [-ATR] counterparts in both languages. In other words, energy is more concentrated in relatively higher formants in [-ATR] vowels. Thus, [-ATR] vowels tend to have a gentler slope in the spectrum and a relatively “brighter” impression.

However, two things should be noted about the spectral tilt as an acoustic correlate of the tongue root feature. First, spectral tilt does not present a consistent difference between the two series of vowels. Depending on language, speaker, or vowel pair, it often fails to distinguish the [+ATR] and [-ATR] vowel pairs (Fulop et al., 1998; Guion et al., 2004). Second, as pointed out by Casali (2008, p. 510), the difference is not as drastic as in the actual distinction between breathy vs. creaky voice vowels in, e.g., the Oto-Manguean language San Lucas Quiavini Zapotec (Gordon & Ladefoged, 2001), the Indo-European (namely, Indo-Iranian) language Gujarati (Fischer-Jørgensen, 1967), and the Hmong-Mien language Hmong (Huffman, 1987), where the distinction between breathy vs. creaky voice performs linguistic functions.

#### 1.3.2.2.4. *Center of gravity*

“Center of gravity” (also known as “spectral mean”), “the measure of the mean of the frequencies of the sound’s spectrum over a specific domain” (Starwalt, 2008, p. 94), was recently tested as an acoustic cue of the tongue root contrast. Starwalt (2008)

---

<sup>5</sup> “H” stands for “harmonic” and “A” for “amplitude,” respectively. A harmonic is defined as an integer multiple of the fundamental frequency (f0), with H1 coinciding with f0. A1, A2, and A3 are the amplitudes of A1, A2, and A3, respectively.

found in a number of Niger-Congo languages such as Ifè, Mbosi, and Kwa a tendency for [+ATR] vowels to have lower center of gravity values than [-ATR] vowels.

Thus far, we have seen that various acoustic measures have been studied in African languages. Compared to the relatively well-studied African languages, the “Altaic” tongue root contrast has suffered from a paucity of instrumental studies except for the aforementioned X-ray studies. However, see Aralova et al. (2011, Ewen) and Kang & Ko (2012, Buriat and Ewen) for recent acoustic studies of the tongue root contrast in Altaic languages.

### *1.3.3. ATR vs. RTR: distinct features or two sides of the same coin?*

There are two tongue root features mentioned in the phonological literature: [Advanced Tongue Root] (= [ATR]) and [Retracted Tongue Root] (= [RTR]). It is highly controversial whether these two features are indeed two distinct features or simply two opposing values of a single feature (Steriade, 1995).<sup>6</sup>

Although the acoustics or gestural mechanisms of tongue root contrast have yet to be decisively established, it is generally accepted that the African tongue root systems utilize [ATR] whereas the Altaic systems utilize [RTR] (Clements & Rialland, 2008; J. Kim, 1989, 1999, 2001; B. Li, 1996). It has been observed (Clements & Rialland, 2008, p. 53) that the African tongue root systems and the similar systems elsewhere have reverse polarity in general: tongue root advancement acts as the dominant value in the former whereas tongue root retraction acts as the dominant value in the latter.<sup>7</sup>

---

<sup>6</sup> Steriade views [ATR] and [RTR] as two distinct features which involve “two opposing gestures on the same or related articulatory dimensions” (pp. 149-152).

<sup>7</sup> Casali (2003), however, reports that many West African languages display a [-ATR] (or [+RTR]) dominance. He also notes a correlation between this [-ATR] dominance and the vowel inventory shape in these languages.

There are other observed differences: comparing Tungusic and African tongue root systems, Li (1996, p. 318ff.) noted that the two systems are distinct with respect to (i) the structure of the vowel inventory and (ii) the neutral vowel(s). For instance, in ATR languages the opposition between ATR vs. non-ATR low vowels (/ɜ/ vs. /a/) tends to disappear first creating the neutral vowel /a/, whereas in RTR languages the opposition between non-RTR vs. RTR high front vowels (/i/ vs. /ɪ/) tends to disappear first, leaving /i/ as the most typical neutral vowel.<sup>8</sup> We will see that Li's observation holds in the vowel systems of other Altaic languages with tongue root harmony, including many Mongolic languages (Chapter 2) and Middle Korean (Chapter 3).

B. L. Hall & Hall (1980) predicted that, phonetically, there may be three types of tongue root harmony system involving one of the following three gestural mechanisms:

- (9)    Set 1 (larger pharynx)    vs.    Set 2 (smaller pharynx)  
 a.    advanced tongue root    vs.    retracted tongue root  
 b.    advanced tongue root    vs.    neutral tongue root  
 c.    neutral tongue root        vs.    retracted tongue root

(B. L. Hall & Hall, 1980, p. 207)

A survey of previous descriptions of a number of African and Mon-Khmer languages by Li (1996, pp. 108-9) seem to support this prediction.

- (10)    Languages            Larger pharynx    Smaller Pharynx    Reference  
 a.    African languages

---

<sup>8</sup> Cenggeltei (1982, p. 41), as cited in Drescher & Zhang (2005, fn. 4), for example, claims that /i/ and its RTR counterpart /ɪ/ are “usually the first pair of vowels in the inventory to undergo neutralization” in Mongolian, Manchu, Finnish, and Hungarian.

Akan	ATR	RTR	(Stewart, 1967)
Igbo	Neu.	RTR	(Ladefoged, 1964)
Anum	Neu.	RTR	(Painter, 1971)
Kalenjin	ATR	Neu. or RTR	(B. L. Hall et al., 1974)
Lutuko	ATR	Neu. or RTR	(ditto.)
Dinka-Nuer	ATR	RTR	(ditto.)
Anywak	ATR	Neu.	(Reh, 1986)
Okpe	ATR	Neu. or RTR	(Omamor, 1988)
b. Mon-Khmer languages			
Jeh	ATR	Neu.	(Gregerson, 1976)
Halang	ATR	Neu.	(ditto.)
Hre	ATR	RTR	(ditto.)
Rengao	ATR	RTR	(ditto.)
Brou	ATR	RTR	(ditto.)
Pacoh	Neu.	RTR	(ditto.)
Mnong Bynor	Neu.	RTR	(ditto.)
Sedang	Neu.	RTR	(ditto.)
Sre	Neu.	RTR	(Manley, 1976)
Cambodian	ATR	Neu.	(ditto.)

Recall that the ultrasound studies introduced in §1.3.2.1.5 (Hudu, 2010; Hudu et al., 2009) showed that [+ATR] vowels in Dagbani are produced with actual tongue root advancement compared to the neutral, inter-speech posture (ISP), supporting the hypothesis on the direct mapping between gestures and phonological features.

Although I am not aware of any studies of the case involving the gestural contrast between RTR vs. neutral position, Hudu's gesture-feature mapping hypothesis predicts

that [+RTR] vowels in Altaic languages will be produced with actual tongue root retraction compared to the ISP. Following these line of research, I assume that [ATR] and [RTR] are two related but separate distinctive features (cf. Steriade, 1995) and hypothesize the following three positions for the tongue root:

(11) Three tongue root positions

Full feature specifications

- a. Advanced      [+ATR, -RTR]
- b. Neutral        [-ATR, -RTR]
- c. Retracted     [-ATR, +RTR]

This distinction of three positions is comparable to the three-height distinction made by two height features, [high] and [low].

A marked gesture is associated with a marked feature specification, which in turn may be manifested as a marked behavior in phonological patterns. Therefore, when selecting one tongue root feature over the other, I will consider markedness as a norm.

(12) Phonological markedness (Rice, 2007, p. 80)

Marked	Unmarked
subject to neutralization	result of neutralization
unlikely to be epenthetic	likely to be epenthetic
trigger of assimilation	target of assimilation
remains in coalescence	lost in coalescence
retained in deletion	lost in deletion

## 1.4. Theoretical framework

In modern phonological theory, a phoneme is viewed as a bundle of *distinctive features* (Jakobson, Fant, & Halle, 1952; Chomsky & Halle, 1968): For example, an alveolar nasal /n/ can be decomposed into features like [+consonantal], [+sonorant], [-approximant], [-continuant], [-lateral], [+nasal], [-strident], [+anterior], and possibly more.

Features can be *contrastive* in some languages while *redundant* in others: for example, it is well-known that aspiration is contrastive in Korean (*pal* ‘foot’ vs. *p<sup>h</sup>al* ‘arm’) but redundant in English (*pie* [p<sup>h</sup>aj] vs. *spy* [spaj], cf. [sp<sup>h</sup>aj]), while voicing is contrastive in English (*tie* vs. *die*) but redundant in Korean (*papo* [pabo] ‘a fool’). In a similar vein, features can be contrastive for some segments while redundant for others within a single language: for example, there are many cases where certain types of segments with an apparent harmonic feature do not participate in the harmonic process (e.g., /i/ in Khalkha Mongolian). However, it is not self-evident which features are contrastive or redundant for what segments in what language. This is especially true when we are studying a language that has not been described very well. It has remained unclear until recently how we arrive at certain feature specifications for phonemes of a given language.

### 1.4.1. Modified contrastive specification

The framework I adopt in this dissertation is *modified contrastive specification*, also known as *contrastive hierarchy theory* (Dresher, 2009 and references therein). This theory holds in its core that only contrastive features are phonologically active.<sup>9</sup> This idea is formulated as follows:

---

<sup>9</sup> The meaning of “activeness” adopted here looks very similar, if not identical, to the definition of



(13) The Contrastivist Hypothesis (D. C. Hall, 2007, p. 20):

The phonological component of a language L operates only on those features which are necessary to distinguish the phonemes of L from one another.

Which features are contrastive and which are redundant is then determined by applying the Successive Division Algorithm (SDA):

(14) The Successive Division Algorithm (Dresher, 2009, p. 15)

- a. Begin with no feature specifications: assume all sounds are allophones of a single undifferentiated phoneme.
- b. If the set is found to consist of more than one contrasting member, select a feature and divide the set into as many subsets as the feature allows for.
- c. Repeat step (b) in each subset: keep dividing up the inventory into sets, applying successive features in turn, until every set has only one member.

The SDA assigns *all* and *only* contrastive features to given phonemes. Thus, we can avoid arbitrariness in feature analysis as long as we properly identify evidence from phonological patterns supporting the contrastive status and relative scope of the proposed features. In this sense, phonological patterns serve “as the chief heuristic for

---

*phonologically active class* in Mielke (2008).

**Phonologically active class** (feature theory-independent definition) (Mielke, 2008, p. 13)

A group of sounds in an inventory which do at least one of the following, to the exclusion of all other sounds in the inventory:

- undergo a phonological process,
- trigger a phonological process, or
- exemplify a static distributional restriction.

determining what the feature hierarchy is for a given language” (Dresher, 2009, p. 162). Also, note that this SDA can be thought of not only as “a restriction on feature specifications” but also as “an acquisition algorithm” (D. C. Hall, 2007, p. 31).

Under this theory, the contrastive specifications of phonemes are considered to be governed by language-particular feature hierarchies. Thus, instead of traditional feature matrices (with full specifications) in (15)a, hierarchically ordered feature specifications as in (15)b are used.

(15) Feature matrix vs. feature hierarchy

a. feature matrix

	/p/	/b/	/m/
[voiced]	-	+	+
[nasal]	-	-	+

b. feature hierarchy (Dresher, 2009, pp. 15–6)

i. [voiced] > [nasal]

ii. [nasal] > [voiced]

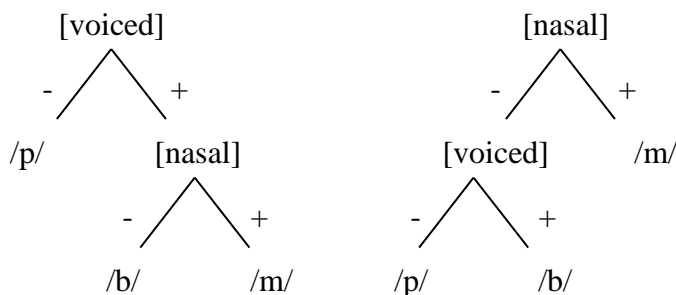

Phonetically, the two systems in (15)b may be identical. However, (15)b.i and (15)b.ii are distinguished by the different rankings of the two features [ $\pm$ nasal] and [ $\pm$ voiced], which assign different scopes: In (i), for instance, [voiced] takes scope over [nasal] and thus the [ $\pm$ nasal] distinction is only relevant for the voiced bilabials. /p/ is not specified for [-nasal] in this case. By contrast, in (ii), [nasal] takes scope over [voiced]

and thus /p/ is also specified for [-nasal], while [ $\pm$ voiced] is only relevant for the two obstruents /p/ and /b/. Therefore, /m/ is not specified for [+voiced]. Then, different predictions will be made as to the phonological patterning of these consonants: for example, /m/ in (i) will pattern together with /b/ as a voiced consonant contrasting with /p/, whereas /m/ in (ii) will not.

#### 1.4.2. Inuit vowel systems (Compton & Dresher, 2011)

An illustrative application of this theory has been proposed for the case of the historical development of the vowel system in the Yupik and Inuit/Inupiaq dialects of Eskimo-Aleut (Compton & Dresher, 2011; also see Dresher, 2009, pp. 164–7).

First, take a look at the following four-vowel system of Proto-Eskimo which is still retained in Yupik and the Diomedé subdialect of Bering Strait Inupiaq:

- (16) Proto-Eskimo vowels (Fortescue, Jacobson, & Kaplan, 1994, p. xi, as cited in Compton & Dresher 2011)

i	u
	ə
	a

In those dialects with the above four-vowel system, synchronic evidence shows that [low], [labial], and [coronal] are phonologically active, thus contrastive: /a/ spreads a feature (assumed to be [low] by Compton & Dresher) to the following vowel, changing the sequences /ai/ and /au/ into [aa]; /u/ changes into [v] when followed by another vowel suggesting a shared feature [labial] between the vowel /u/ and the consonant /v/; /i/ palatalizes the following consonant suggesting that /i/ bears a

palatalizing feature (assumed to be [coronal] by Compton & Dresler). These three features are ordered as follows:

(17) Proto-Eskimo (Compton & Dresler, 2011, p. 221)

a. SDA: [low] > [labial] > [coronal]<sup>10</sup>

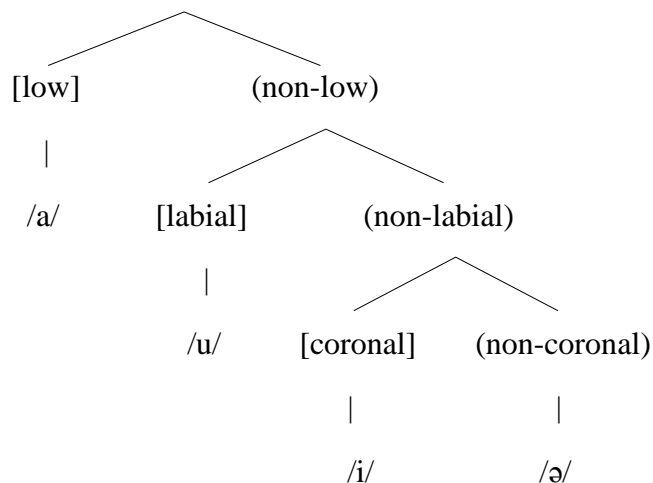

b. Contrastive specifications

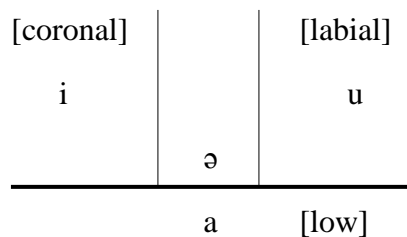

According to the above contrastive hierarchy, /ə/ (and its reflex, *weak i*, in some dialects)<sup>11</sup> is the least marked for any of the contrastive features. This is empirically

<sup>10</sup> The relative ordering between [labial] and [low] is not crucial and thus the feature hierarchy [labial] > [low] > [coronal] would be compatible with the analysis. See Compton & Dresler (2011, p. 221, fn. 27).

<sup>11</sup> Some modern dialects such as North Alaskan Inupiaq have two kinds of *i*: “strong *i*,” the reflex of the Proto-Eskimo \*/i/ triggering palatalization of alveolar consonants, and “weak *i*,” the reflex of the Proto-Eskimo vowel \*/ə/ which does not trigger palatalization (Compton & Dresler, 2011)



prediction is borne out: it is used as the epenthetic vowel in loanwords, where it is inserted to satisfy phonotactic restrictions.

This analysis explains the typological gap across Inuit dialects (Compton & Drescher, 2011, pp. 224–5). We have seen two types of Inuit dialects: palatalizing varieties with four vowels and non-palatalizing varieties with three vowels. However, there is no palatalizing variety with three vowels. This is a direct consequence of the merger of \*/ə/ with \*/i/. In the contrastive hierarchy analysis proposed by Compton and Drescher, the loss of \*/ə/ means the concurrent loss of the contrastive status of [coronal], which in turn means the loss of palatalization involving the contrastive feature [coronal].

Several important aspects of the contrastive hierarchy theory should be noted from the above analysis of Inuit. First, markedness is determined by a language-specific contrastive hierarchy, rather than a universally fixed scale. For example, as we saw in Inuit vowel systems, /i/ in a four-vowel system (/i, ə, u, a/) patterns as marked with respect to the central vowel /ə/, whereas /i/ in a three-vowel system (/i, u, a/) may behave as the least marked, depending on the contrastive hierarchy of the specific language.

Second, a contrastive hierarchy captures phonological insensitivity to phonetic details in a straightforward way. Recall that /i/ in most Inuit dialects does not trigger palatalization, although it is phonetically [+coronal] involving constriction made by the tongue blade. This mismatch between the phonetic detail and the phonological patterning was accounted for by the Contrastivist Hypothesis: [coronal] is not a contrastive feature in this system and, thus, is phonologically inactive.

Third, following Stevens, Keyser, & Kawasaki (1986), Drescher argues that “phonological contrasts can be enhanced by phonetic specification of noncontrastive features” (Drescher, 2009, p. 168). The notion of *phonetic enhancement* accounts for

why /i/ in three-vowel Inuit varieties surfaces as [i], not [ə], despite its unmarked status comparable to that of /ə/ in four-vowel systems. Although [coronal] is not used as a contrastive feature, it is still available as a redundant feature to enhance the unmarked features of /i/ (Compton & Dresher, 2011, pp. 223–4).

Fourth, the same inventories with the same set of features can have different feature hierarchies, thus allowing for variability (Avery, Dresher, & Rice, 2008, p. 1). The Inuit examples above provide us with no such cases, but we will see later in Chapter 5 how a contrastive hierarchy exploits this characteristic of the theory in explaining the microvariation found between Mongolic and Tungusic vowel harmony patterns.

#### *1.4.3. A formal model of contrastive hierarchy changes*

So far we have seen what the contrastive hierarchy theory is and how it applies to individual languages. As is clear in the development of Inuit vowel systems, a contrastive feature at an earlier stage can lose its contrastive status at a later stage. But how? The current version of contrastive hierarchy theory (Dresher, 2009) does not seem to provide us with a model of contrastive hierarchy changes. Therefore, in addition to the central tenets of the theory, here I propose a formal model of feature hierarchy changes as follows:

- (19) Types of contrastive hierarchy changes
  - a. Promotion and demotion
  - b. Emergence and submergence
  - c. Fusion and fission
  - d. Reanalysis

*Promotion* (and *demotion* in a reverse order of steps)<sup>12</sup> can be schematized as follows:

(20) Promotion of a feature [D]

- a. Stage I [A] > [B] > [C] > **[D]**
- b. Stage II [A] > [B] > **[D]** > [C]
- c. Stage III [A] > **[D]** > [B] > [C]

Note that the change from Stage I to Stage II may be equally viewed as either the promotion of [D] or the demotion of [C] since the result is apparently an “inversion” of two adjacent features. However, the next stage (Stage III) would make it clear that the entire change can be better explained in terms of the (consecutive) promotion of [D] rather than a combination of the demotion of [C] and the demotion of [B] (or the simultaneous demotion of “[B] > [C]”). An example of a consecutive promotion of a contrastive feature is exemplified by the change from Old Mongolian to modern Khalkha Mongolian (§0).

(21) Promotion of [low] in the Mongolic languages

OM	[coronal] > [labial] > [RTR] > <b>[low]</b>
↓	[coronal] > [labial] > <b>[low]</b> > [RTR]
Khalkha	[coronal] > <b>[low]</b> > [labial] > [RTR]

---

<sup>12</sup> It may be the case that there is only promotion. I cannot find any empirical or theoretical motivation for speakers/learners to weaken any given contrast (demotion), since there is nothing to gain by doing so from the perspective of contrast *per se*. On the contrary, promotion makes more sense in terms of motivation: it could be a compensation strategy for the weakening/neutralization of phonological contrast. However, I will simply assume that both promotion and demotion are legitimate types of change and leave the question to future research.



*Emergence* is a change whereby a redundant feature becomes contrastive and *submergence* (=loss) is a change whereby a contrastive feature becomes redundant, at the “bottom” of the hierarchy, a position after which a hypothetical line of demarcation between contrastive vs. redundant features can be drawn. In this sense, they may be viewed as a special case of promotion or demotion, respectively. However, it seems that emergence and submergence are normally associated with the increase and decrease of the inventory size, whereas other hierarchical changes might not be directly relevant in this respect.

(22) Emergence/submergence of a feature [D]

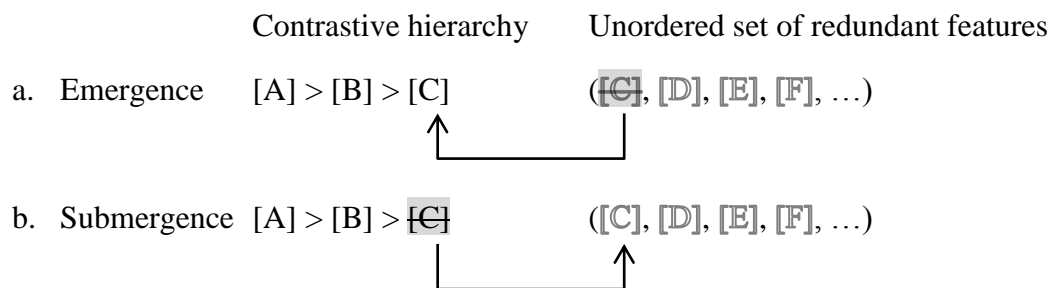

We have already seen an example of *submergence* (*loss*) of a bottom-ranked feature in the Inuit vocalic history (§1.4.2).

(23) Loss of [coronal] in Inuit

a. Proto-Eskimo                      [low] > [labial] > [coronal]                      (17)

b. Inuit (with 3 vowels)              [low] > [labial]                      (18)

We will see in later chapters that a *loss* is quite a common phenomenon in the history of Northeast Asian languages.

*Fusion* and *fission* are schematized as follows:

(24) Fusion vs. fission

a. Fusion

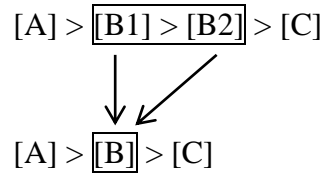

b. Fission

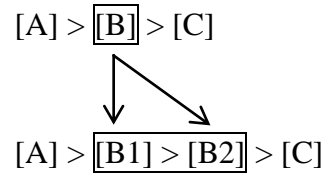

Both fusion and fission are assumed to apply only to two adjacent features of the same type such as features relevant to front vs. back contrast or high vs. low contrast. An example of a fission is illustrated with the change from Middle Korean to Early Modern Korean whereby the fission of a single height feature [low] into two height features [low] and [high] compensated for the loss of [RTR] (§3.3).

(25) Fission of a single height feature [low] into two height features [low] and [high]

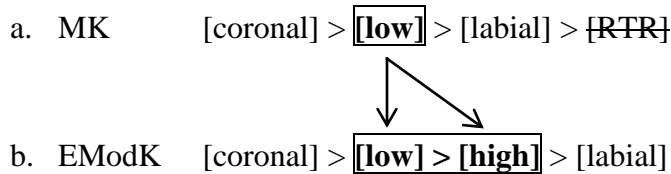

*Reanalysis* means a reinterpretation of a redundant feature intrinsic to a contrastive feature as a replacing contrastive feature. This is exemplified by a change in the Mongolic language Kalmyk/Oirat whereby the “redundant” difference in the position of the tongue body (front vs. back)—concomitant with the “contrastive” difference in the position of the tongue root—has been phonologized (§2.3).

(26) Reanalysis of [αRTR] as [αdorsal] (cf. Vaux, 2009)

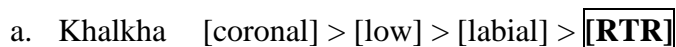

b. Kalmyk [coronal] > [low] > [labial] > **[dorsal]**

In addition to these types of changes, I propose two principles governing the contrastive hierarchy changes: an *Adjacency Principle* and a *Minimal Contrast Principle*. First, the Adjacency Principle requires that any two contrastive features involved in a change must be adjacent, whether they are in the pre-change state or in the post-change state. This principle was already applied above with the schematic representations and illustrations of promotion/demotion (20) (21) and fusion/fission (24) (25). If we assume that the bottom-ranked contrastive feature and all redundant features (in an unordered set) are in fact adjacent, this principle also applies to the cases of emergence/submergence (22) (23).

(27) Adjacency Principle

Any two features involved in a contrastive hierarchy change must be adjacent to each other.

A notable consequence of this Adjacency Principle is the conservatism of changes: promotion/demotion is applied in a step-by-step mode and, in fusion/fission and emergence/submergence, the relative rankings of the other features are left unchanged.

Second, the Minimal Contrast Principle is based on a hypothesis that *minimal contrast*, which is defined as follows, plays a decisive role in the phonology:

(28) Minimal Contrast

A Minimal Contrast is a contrast between any two segments sharing a terminal branching node under a given contrastive hierarchy.

Note here that minimal contrast is not defined as the contrast between any two segments that only differs with respect to the lowest-ranked feature,<sup>13</sup> but as the contrast between any two segments sharing a “terminal branching” node. Consider the following contrastive hierarchy which will be discussed in more detail in (§4.2.1.1.3):

(29) Contrastive hierarchy for Written Manchu (cf. Drescher & Zhang, 2005)

SDA: [low] > [coronal] > [RTR] > [labial]

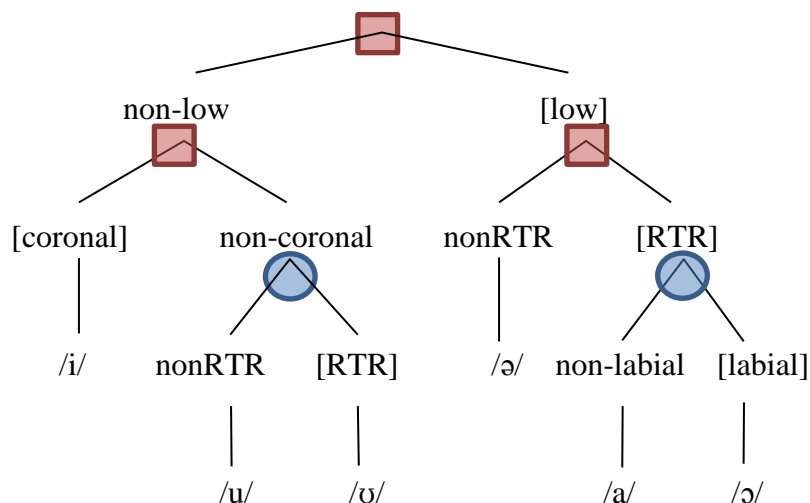

In the above representation of the Written Manchu contrastive hierarchy, all non-terminal branching nodes are marked by “■” and all terminal branching nodes are marked by “●.” According to the definition in (28), both /u, ʊ/ and /a, ɔ/ constitute minimal contrasts, although the first pair contrasts with respect to the feature [RTR] and the second contrasts with respect to the feature [labial].

<sup>13</sup> I suppose this is a tempting idea and indeed most of the relevant examples in this dissertation can also be accounted for using this definition. However, there are certain cases where this may not work such as Written Manchu. Note in (29) below that /u/ and /ʊ/ in Written Manchu, which merge into /u/ in Spoken Manchu, would not minimally contrast with each other under this definition of minimal contrast because [RTR] is not the lowest-ranked feature in the hierarchy.

Recall that the *minimal contrast* between Proto-Eskimo \*/i/ and \*/ə/ has been lost in many modern dialects. Even in many of those dialects which retain the underlying distinction, /i/ and /ə/ are often neutralized as surface [i]. This suggests that *minimal contrast* is vulnerable to phonological neutralization/merger. Thus, as a working hypothesis, I assume that vowel merger is a loss of *minimal contrast* conditioned by the language-particular feature hierarchy.

(30) Minimal Contrast Principle

Phonological merger operates on a minimal contrast.

To put it the other way around, a certain merger pattern provides us with an important clue as to what the contrastive hierarchy of the language in question looked like at an earlier stage.

#### *1.4.4. The Contrastivist Hypothesis vs. Visibility Theory*

The Contrastivist Hypothesis (§1.4.1) is empirically falsifiable: on the one hand, it could turn out to be empirically inadequate (“too weak”) if more features are phonologically active than are allowed to be contrastive. On the other hand, it could turn out to be “too strong” if there are cases where noncontrastive features are also phonologically active. See Dresher (2009, pp. 206–209) for a detailed discussion.

In this dissertation, I will show that the vowel patterns in the languages I investigate can all be accounted for under the Contrastivist Hypothesis which predicts that no noncontrastive (redundant) features will play a role in the phonology. This will stand in direct contrast with theories allowing noncontrastive features to be accessible in the phonology: e.g., Visibility Theory (Calabrese, 2005; Nevins, 2010, among others).

(31) Three classes of feature specifications in Visibility Theory (Calabrese, 2005)

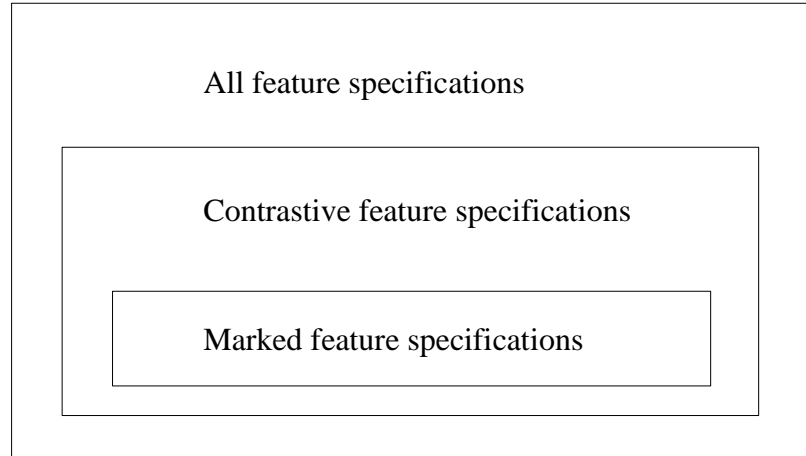

Visibility Theory assumes that features are always fully specified and phonological rules (or constraints) can be relativized to operate on one of the three classes of feature specifications given in (31) above: *all*, *contrastive*, or *marked* feature specifications. This means that in some cases we may have rules that are sensitive to noncontrastive feature specifications. Nevins (2010) applies this view to a number of Altaic harmony patterns (including vowel and consonant harmony) in Classical and Khalkha Mongolian (Mongolic); Oroch, Classical and Sanjiazi Manchu, and Sibe (Tungusic); and many other Turkic languages such as Turkish, Uyghur, Karaim, Altai, Shor, and so forth. Therefore, I will compare my analysis based on the Contrastivist Hypothesis with Nevins’s analysis based on the Visibility Theory where necessary.

However, it is reported in the contrastive hierarchy literature that there are cases which suggest that the Contrastivist Hypothesis may be too strong: e.g., in long high vowel lowering in the Penutian language Yowlumne Yokuts (D. C. Hall, 2007), a noncontrastive (“prophylactic”) feature may play a role in the phonology. This “prophylactic” feature is not as active as other “contrastive” features. Rather, it has a

purely passive function: it is invisible to the phonological computation but “serves only to distinguish segments that would otherwise be neutralized” (Dresher, 2009, p. 209). The existence of prophylactic features would require a refinement of the Contrastivist Hypothesis from its current form. However, I will not dwell on this issue in this dissertation. See Hall (2007) and Dresher (2009, pp. 208–9) for further discussion of prophylactic features. Here I would like to simply point out that, as will be clear in my analysis, none of the features at issue in the Northeast Asian languages require prophylactic status.

#### *1.4.5. Articulator features*

In the Inuit example introduced in §1.4.2, Dresher used vowel place features like [coronal] and [labial] assuming that they are interchangeable with [front] and [round], respectively. This array of features is a product of current developments in feature geometry, whether it is an *articulator-based* model (Sagey, 1986; Halle, 1995; Halle, Vaux, & Wolfe, 2000) or a *constriction-based* model (Clements, 1991; Clements & Hume, 1995).

In a constriction-based model of feature geometry (Clements & Hume, 1995), a single set of place features are assumed to apply to both consonants and vowels: front vowels are coronal forming a natural class with coronal consonants; back vowels are dorsal forming a natural class with dorsal consonants; round vowels are labial forming a natural class with labial consonants.

(32) Place feature (Clements & Hume, 1995, p. 277)

Labial: involving a constriction formed by the lower lip

Coronal: involving a constriction formed by the front of the tongue

Dorsal: involving a constriction formed by the back of the tongue

It is intended in this model that interactions between consonants and vowels can be formalized in a very straightforward way. For example, palatalization is schematized as in (33):

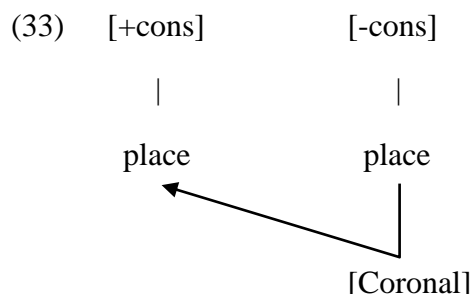

Here, palatalization is treated as simply synonymous with coronalization whereby front vowels spread their [coronal] specification onto the preceding consonant. As pointed out by Calabrese (2005, p. 304), although the coronality of high front vocoids such as /i/ and /j/ seems to be articulatorily correct, it is rather less clear whether nonhigh vowels also involve the coronal articulator, i.e., the tongue tip or blade. According to Kenstowicz (1994, p. 465), unlike coronals that are produced by contracting the intrinsic longitudinal muscles of the tongue, front vowels are produced by contracting the genioglossus, an external muscle that connects the tongue body with the lower jaw. (See also Kenstowicz, 1994, pp. 143–4.)

In Articulator Theory as developed by Sagey (1986), Halle (1995), and Halle et al. (2000), features are viewed as having a dual function (Halle et al., 2000, p. 388): On the one hand, they have a contrastive function, thus serving as “mnemonic devices that distinguish one phoneme from another”; On the other hand, they also have a substantive function, thus serving as instructions for a specific action of the proposed six articulators—Lips (Labial), Tongue Blade (Coronal), Tongue Body (Dorsal),



Tongue Root (Radical), Soft Palate (Rhinal), and Larynx (Glottal). One such model is presented below:

(34) Basic feature geometry in Halle et al. (2000, p. 389)

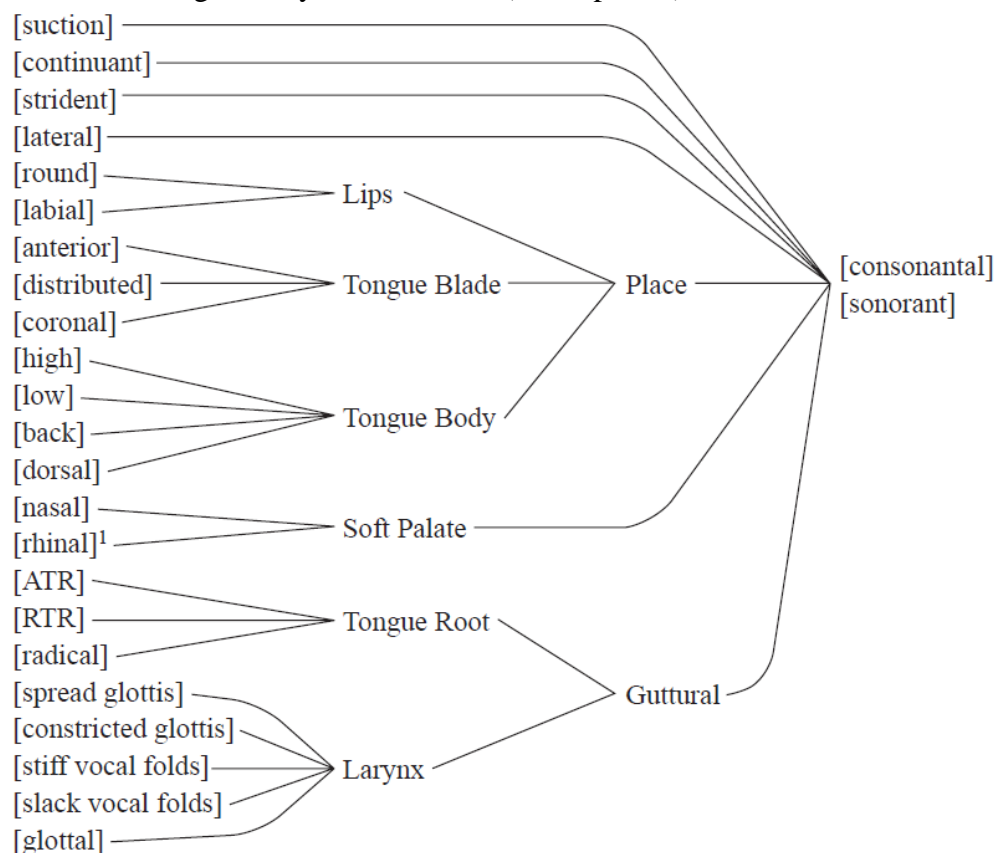

Adapting Articulator Theory, specifically following Calabrese (2005, pp. 312–3), I distinguish simple front vowels and coronal front vowels: all front vowels are articulated by the Tongue Body fronting, namely by the feature configuration [-dorsal] (more precisely, [Dorsal, -back]), whereas “coronalizing” vowels (usually, but not necessarily, high front vowels) involve an additional articulator Tongue Blade, and are thus [+coronal] (more precisely, [-anterior, +distributed]). ([-dorsal] and [+coronal] used here are not due to Calabrese, but rather simplified specifications I will use throughout this dissertation.)

(35) Calabrese’s representation of high front vowels and nonhigh front vowels

a. high front vowels:

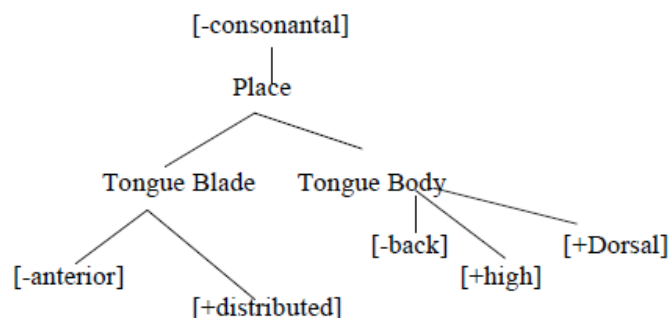

b. nonhigh front vowels:

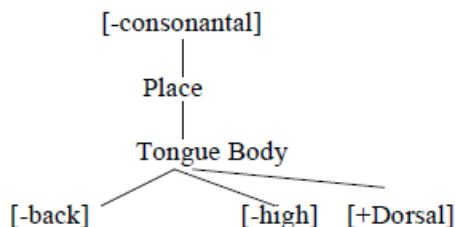

Under this analysis, velar fronting and coronalization are naturally distinguished: velar fronting is understood as “spreading of the feature [-back],” whereas coronalization, usually triggered by front high vocoids, is understood as “spreading of the coronal terminal features of the high front vowels,” namely, [-anterior] and [+distributed] (Calabrese, 2005, p. 315).

Insofar as this thesis adopts Dresher’s contrastive hierarchy approach, however, high front vowels may or may not be contrastively [+coronal] depending on the particular contrastive hierarchy of the language in question. For example, as we have seen in the previous section, /i/ in the “palatalizing” dialects of Inuit is viewed as having a [+coronal] specification, whereas /i/ in the “non-palatalizing” dialects lacks contrastive [+coronal].

## 1.5. Structure of the dissertation

The structure of the dissertation is as follows:

Chapter 2 is an investigation of the synchrony and diachrony of the Mongolic vowel systems. The main point of this chapter is that, contra the conventional assumption (e.g., Poppe, 1955), RTR is the original harmonic feature in Old Mongolian (and Proto-Mongolic as well), and that the vocalic history of Mongolic from Old Mongolian to modern varieties is better explained as an RTR-to-palatal shift, rather than as a palatal-to-RTR vowel shift as hypothesized by Svantesson (1985).

Chapter 3 also presents an innovative view (i) that Middle Korean (and arguably Old Korean as well) had an RTR contrast-based vowel system and (ii) that various issues in the Korean historical phonology receive better treatment under the contrastive hierarchy approach. In addition, Chapter 3 overturns Ki-Moon Lee's (1964, 1972; see also K.-M. Lee & Ramsey, 2011) Korean vowel shift hypothesis, a deeply entrenched view among Koreanists since the 1960s.

Chapter 4 presents contrastive hierarchy analyses of the Tungusic languages. This line of research has already been applied to Manchu (Dresher and Zhang, 2005) and Oroqen (Zhang, 1996). It has also been argued that RTR is the original harmonic feature in Tungusic (Li, 1996). However, this thesis makes new contributions that can be summarized as follows: (i) first, I argue that Manchu is better analyzed as an RTR, not an ATR, language (contra Zhang and Dresher, 2004); second, I will show that Oroch has the same contrastive hierarchy as Manchu, contra the view of Tolskaya (2008) and Nevins (2010), who claim that Oroch cannot be analyzed in a contrastive hierarchy approach; third, I also present contrastive hierarchy analyses of other Tungusic languages and argue that RTR, not ATR, is indeed the original contrast in all Tungusic languages.

Chapter 5 is rather different from the previous chapters in the sense that it mostly deals with a theoretical issue: transparency/opacity in vowel harmony and the Contrastivist Hypothesis (Hall, 2007). The main issue here is that Mongolic /i/ is transparent, whereas Tungusic /i/ is opaque to labial harmony. The contrastive hierarchy approaches to the Mongolic and Tungusic vowel systems in the previous chapters, coupled with a “fusional harmony” approach (Mester, 1986), provide a very simple but elegant solution to the minimal difference between the two languages, allowing us to maintain the Contrastivist Hypothesis.

Chapter 6 addresses empirical and theoretical implications of the findings in the main chapters and concludes the thesis. The main issues are (i) a typological sketch of Altaic vowel systems including a comparison of Mongolic/Tungusic/Middle Korean with Turkic vowel systems (4-feature system vs. 3-feature system and the existence vs. absence of contrastive [coronal]), (ii) a brief discussion of the implications of my analysis with respect to the proto-Altaic vowel system (as an RTR system), and (iii) a discussion on the typology of contrastive hierarchy changes found in Northeast Asian languages.

## CHAPTER TWO

### MONGOLIC LANGUAGES

#### **2.1. Introduction**

It had long been assumed that the Mongolic languages including Proto-Mongolic have a palatal harmony system (Vladimircov, 1929; Poppe, 1955; and many other references cited in Svantesson et al., 2005, pp. 220-1, Appendix B 1.1.1), until Svantesson's (1985, 1995) acoustic studies showed that some modern Mongolic varieties such as Khalkha and Chakhar have a "pharyngeal," not a palatal, harmony system. Faced with this discrepancy between the RTR system in modern Mongolic languages and the assumed palatal system in pre-modern Mongolic languages (Poppe, 1955; Janhunen, 2003a; Rybatzki, 2003a; Svantesson et al., 2005), Svantesson (1985) proposed a vowel harmony shift hypothesis which holds that the harmonic contrast has shifted from a palatal to an RTR contrast, except for Kalmyk/Oirat which retains the putative old palatal contrast. In this chapter, I challenge this idea by a careful examination of the synchrony and diachrony of the Mongolic vowel systems within the framework of the contrastive hierarchy theory introduced in Chapter 1 and propose a reverse shift from RTR to palatal harmony.



According to Lewis (2009), one of the most recent classifications, the Mongolic family includes about 11 languages. Most of them belong to the eastern branch, leaving only one nearly-extinct language, Moghol, in the western branch. The eastern branch can be divided further into Dagur, Monguor, and Oirat-Khalkha groups. The three best-known Mongolic languages, (Khalkha) Mongolian, Buriat, and Oirat, belong to the last group. The “Gansu-Qinghai” group (= “Monguor” group) can be further divided into Bonan-Santa (=Dongxiang) and Mongghul-Mangghuer (“Monguor”) with Shira Yugur (and possibly Kangjia) being transitional towards Mongolian Proper (Nugteren, 2003; Rybatzki, 2003b, p. 368).

(1) Lewis (2009)

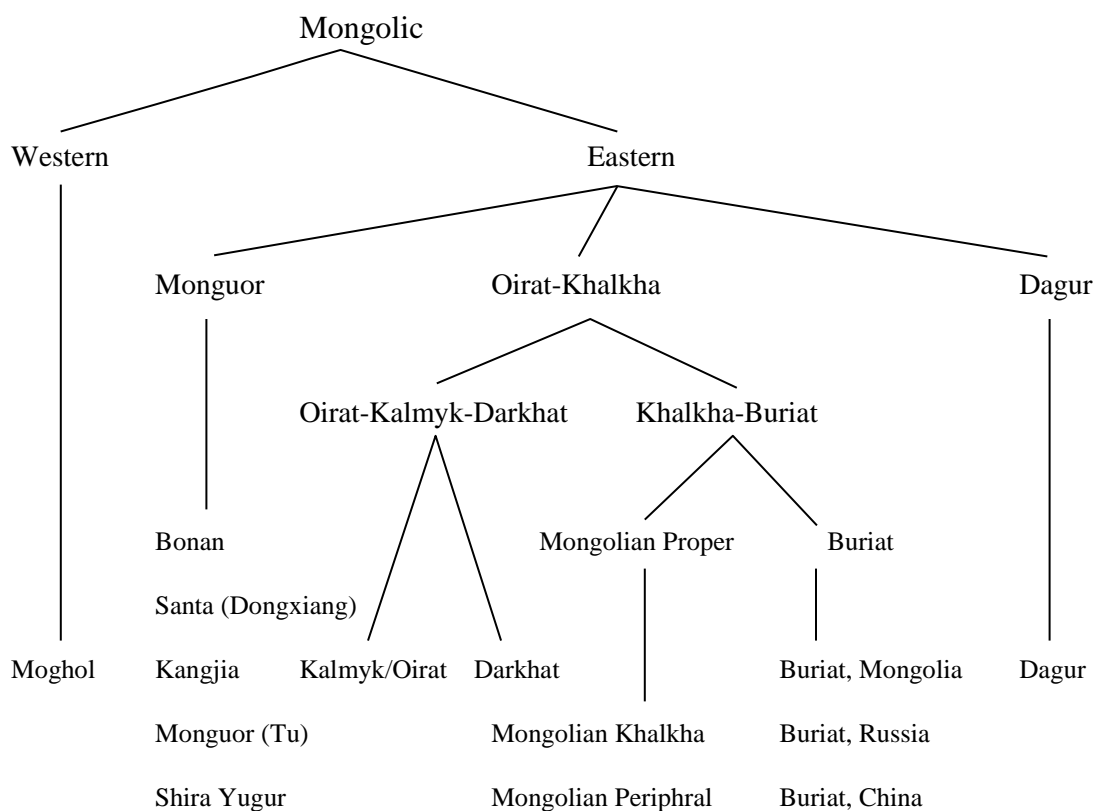

Although Darkhat, spoken in northwestern Mongolia, is often regarded as a separate language with some Oirat features, I will treat it as a dialect of Mongolian Proper (Northern Khalkha) following Svantesson et al. (Svantesson et al., 2005, pp. 142–143) (cf. Janhunen, 2003b, p. 179).

Not included in the tree above is Khamnigan Mongol, which has only recently been recognized as a separate language. According to Janhunen (2003c, p. 85), it might be the most conservative Mongolic language, because it lacks almost all the innovations observed in its neighbors such as Dagur, Buriat, and Mongolian Proper. We will see later that Khamnigan Mongol can be placed somewhere between Buriat and Dagur in terms of its vowel contrast as well as its geographical distribution.

Although I simply adopt Lewis’s classification here, it has to be noted that no consensus has ever been reached on the classification (and the methods of classification) of the Mongolic languages (Rybatzki, 2003b, p. 368).<sup>1</sup> The most frequently encountered classification would be a dichotomy based on the geographical distribution of the languages such as those of Vladimircov (1929) and Poppe (1955), who divided Mongolic languages into two main branches, Eastern vs. Western Mongolic.

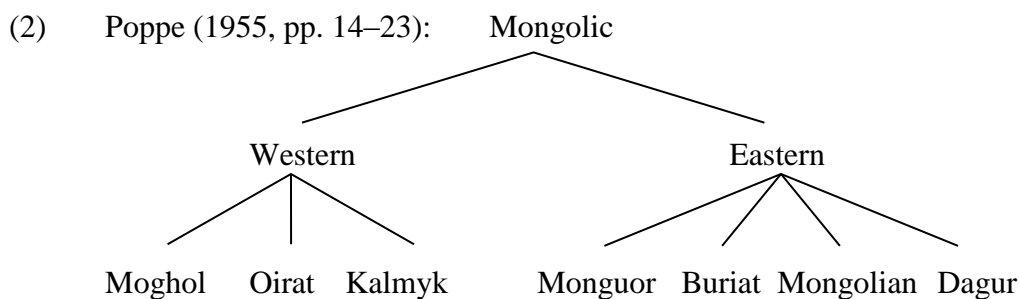

---

<sup>1</sup> See Svantesson (2000), Rybatzki (2003b), and Indjieva (2009, pp. 187–94, Appendix II) for further discussion on this issue.



Notably, Kalmyk and Oirat are grouped together with Moghol into Western Mongolic in this classification. Doerfer (1964, pp. 41–3) also adopted the Eastern vs. Western dichotomy, but treated Moghol, Monguor, Santa, Shira Yugur, and Dagur as isolated languages.

Bertagaev (1968), Sanzheev (1977), and Binnick (1987) proposed a different classification on the basis of a smaller number of synchronic features. For instance, Sanzheev (1977) divided Mongolic languages into three groups based on vowel harmony: a northern “synharmonic” group, a southeastern “non-synharmonic” group, and an intermediate group.

(3) Sanzheev (1977)

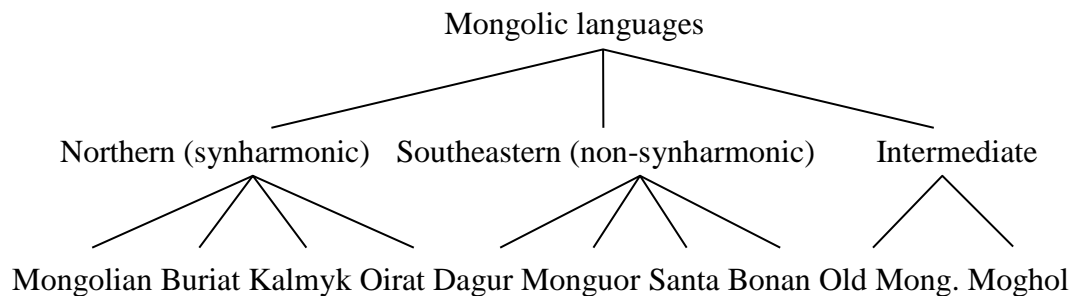

In a similar but not identical vein, Svantesson (2000) suggests a classification based on the diachrony of the vowel system. Using the proposed Mongolic vowel shifts (Svantesson, 1985, 1995)<sup>2</sup> as the primary innovation, he divided the Mongolic languages into three groups: East Mongolic, West Mongolic, and Oirat. According to this classification, Oirat has a special status as a language with a conservative vowel system.

<sup>2</sup> Svantesson’s (1985) vowel shift hypothesis will be introduced and criticized in great detail in §0.

- (4) Svantesson (2000, pp. 203–204)
- a. Oirat (no vowel shift)
  - b. East Mongolic (vowel shift without merger)
    - i. Shira Yugur
    - ii. Buriat, Khamnigan, Mongolian
    - iii. Dagur
  - c. West Mongolic (vowel shift with merger): Santa, Monguor, Bonan, Moghol

Binnick (1987) and Nugteren (1997) suggested a different geographical criterion for classification: a dichotomy between “central” vs. “peripheral,” which places Dagur, Buriat, Khalkha, and Kalmyk/Oirat in the central group, and the Gansu-Qinghai varieties and Moghol in the peripheral group.

- (5) Nugteren (1997, p. 215), as cited in Indjieva (2009, p. 192)

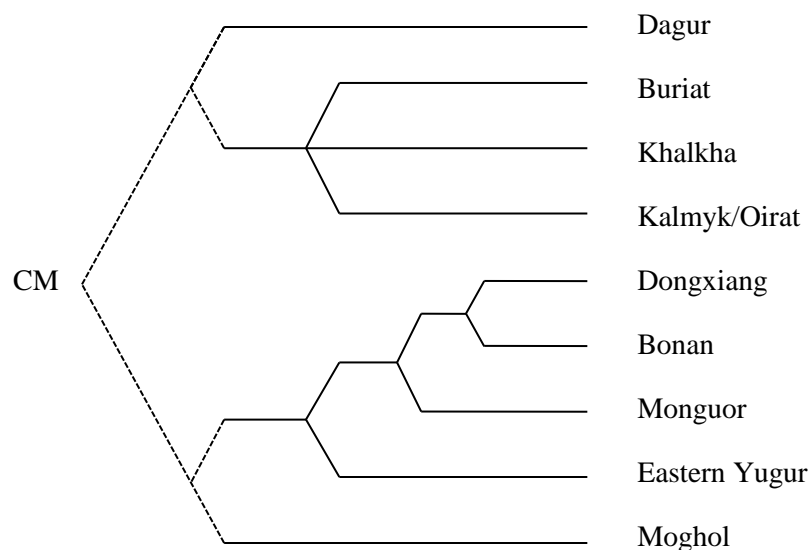

Rybatzki (2003b) is the most recent attempt to draw a taxonomic conclusion based on a comprehensive survey of 32 phonological innovations, 42 morphosyntactic features, and 452 lexical items.<sup>3</sup> The result implies the following six groups:

- (6) Rybatzki (2003b, pp. 388–389)
- a. Northeastern Mongolic (NE): Dagur
  - b. Northern Mongolic (N): Khamnigan Mongol, Buriat
  - c. Central Mongolic (C): Mongol proper, Ordos, Oirat
  - d. South-Central Mongolic (SC): Shira Yugur
  - e. Southeastern Mongolic (SE): Monguor (Mongghul & Mangghuer), Bonan, Santa
  - f. Southwestern Mongolic (SW): Moghol

One striking result is that the two most closely related languages are Khalkha and Oirat with 45 shared innovations (Rybatzki, 2003b, p. 388).<sup>4</sup> Rybatzki’s taxonomy also reveals a very close relationship between Khamnigan Mongol and Buriat (33 shared innovations). Shira Yugur seems to have “equally strong bonds with the Buriat-Khalkha-Ordos-Oirat group and the Mongghul-Mangghuer-Bonan-Santa” group (Rybatzki, 2003b, p. 388).

---

<sup>3</sup> Thus, this classification seems to be more reliable than others. However, we should be careful in assessing Rybatzki’s methodology. As he acknowledged, for example, he treated all taxonomic features as being equally significant (i.e., one feature = one point), although not all taxonomic features may be equal in their relevancy or significance (Rybatzki, 2003b, p. 386f.).

<sup>4</sup> It should be noted that Rybatzki (2003b, p. 368) assumed the same type of vowel harmony, i.e., palatal harmony, for all Mongolic languages, which I believe is wrong. However, this would not have distorted the result since Khalkha and Oirat still have 44 other shared innovations which still qualify the two languages for the most closely related.

A full-scale intra-Mongolic taxonomy is far beyond the scope of this dissertation. I will not attempt a serious taxonomical classification of the Mongolic languages. However, as a result of an extensive examination of the vowel systems of the Mongolic languages, I do recognize certain distinguishable types in terms of the contrastive hierarchy of the vowel systems (§2.2) reflecting different historical paths (§2.3).

### *2.1.2. Structure of Chapter 2*

Chapter 2 is structured as follows. Section 2.2 explores a range of modern Mongolic vowel systems and classifies them into four types based on their contrastive hierarchies. Section 2.3 revisits Svantesson's Mongolic vowel shift hypothesis and proposes a new, reverse vowel shift. Section 2.4 briefly discusses the implications of this new approach to the classification of the Mongolic languages.

## 2.2. Vowel contrast in the Mongolic languages

In this section I investigate a wide variety of vowel inventories and vowel-related phonological patterns found in the modern Mongolic languages and propose a contrastive hierarchy analysis for each language based on major phonological processes such as palatalization, umlaut, vowel harmony, and vowel merger. The result shows that the seemingly diverse Mongolic vowel systems fall into one of the four different types depending on their contrastive hierarchies, as summarized in (7) below. This will serve in Section 4 as the basis of the reconstruction of the Old Mongolian (OM) vowels as well as the revision of the Mongolic vowel shift hypothesis.

(7) Mongolic vowel systems

a. Type I: Khalkha type languages (Mongolian Proper)

SDA: [coronal] > [low] > [labial] > [RTR]

b. Type II: Monguor type languages (Monguor, Santa, Bonan, Moghol, Shira Yugur, Kangjia)

SDA: [coronal] > [low] > [labial] (> [RTR])

c. Type III: Dagur type languages (Dagur, Buriat, Khamnigan)

SDA: [coronal] > [labial] > [RTR] (> [low])

d. Type IV: Oirat type languages (Kalmyk/Oirat)

SDA: [coronal] > [low] > [labial] > [dorsal]

### 2.2.1. Type I: *Khalkha type languages*

Khalkha (Halh) type languages can be characterized as having rigorous RTR harmony. All the Mongolian dialects (“Mongolian Proper”) belong to this type, although they are divided into several dialectal sub-groups as shown below:

- (8) Dialects of the Mongolian language (Svantesson et al., 2005, p. 143)<sup>5</sup>
- a. Northern Khalkha (1.5 mil.): Central Khalkha, northern part of Western Khalkha, Darkhat (20,000), Khotogoit, South Selenge “Buriat” (Tsongol-Sartul, 20,000).
  - b. Southern Khalkha (1.1 mil.): Southern part of Western Khalkha, Gobi Khalkha, Eastern Khalkha, Southern Khalkha, Dariganga (20,000), Shilingol (50,000), Ulan Tsab (30,000), Sönit (40,000).
  - c. Southern Mongolian (350,000): Chakhar (100,000), Üjemchin (75,000), Keshigten (20,000), Ordos (130,000).
  - d. Naiman (100,000)
  - e. Eastern Mongolian (2.1 mil.): Baarin (110,000), Aru Khorchin (80,000), Ikh Minggan, Ongniut (50,000), Kharachin (350,000), Tümet, Khüree (80,000), Monggoljin, Khorchin (1.1 mil.), Gorlos (35,000), Heilongjiang Dörbet (35,000), Jalait (140,000), Jarut (90,000).
  - f. Urat (40,000)

I will first discuss the Khalkha vowel system in detail and propose its contrastive hierarchy. Then, I will show that other Mongolian dialects such as Chakhar and Baarin share the same contrastive hierarchy, despite some apparent differences in the vowel inventory.

---

<sup>5</sup> See Janhunen (2003b, pp. 178–181) for a slightly different classification.

### 2.2.1.1. Khalkha Mongolian

Khalkha, which is the national standard in the Republic of Mongolia, has 7 vowel phonemes:

(9) Khalkha vowel system (Svantesson, 1985)

i	u
	ʊ
e <sup>6</sup>	o
a	ɔ

Adopting the vowel features developed by Wood (1975, 1979), Svantesson et al.

(2005) proposes the following feature specifications for Khalkha Mongolian vowels:

(10) Khalkha vowel classes (Svantesson et al., 2005)

non-pharyngeal Vs	pharyngeal Vs	
i [ ]		
u [R]	ʊ [FR]	O: [open]
e [O]	a [FO]	R: [round]
o [OR]	ɔ [FOR]	F: [pharyngeal]

Although this analysis captures the fact that Khalkha vowel harmony is based on tongue root retraction (specified by the feature [pharyngeal]) (Svantesson, 1985), it faces several problems. First, under this analysis, it is very difficult to give a plausible

---

<sup>6</sup> Although Svantesson (2003) and Svantesson et al. (2005, p. 22) report that the short vowel /e/ occurs only in non-initial syllables in colloquial Ulaanbaatar Khalkha, Khalkha speakers seem to maintain this short vowel in all positions at least in careful speech (cf. Amy LaCross, p.c.).

account for the phonological processes triggered by /i/ such as palatalization and umlaut, because /i/ is considered to be the least marked vowel<sup>7</sup> with no specification at all and its [palatal] feature is filled in by a phonetic realization rule (a redundancy rule). Second, the [R] ([round]) specification for high rounded vowels makes it difficult to explain the different behavior between high vs. low rounded vowels: unlike the low rounded vowels /o/ and /ɔ/, the high rounded vowels /u/ and /ʊ/ do not trigger labial harmony.

My analysis of the Khalkha vowel system is shown below.

(11) Contrastive hierarchy for Khalkha Mongolian

- a. SDA: [coronal] > [low] > [labial] > [RTR]

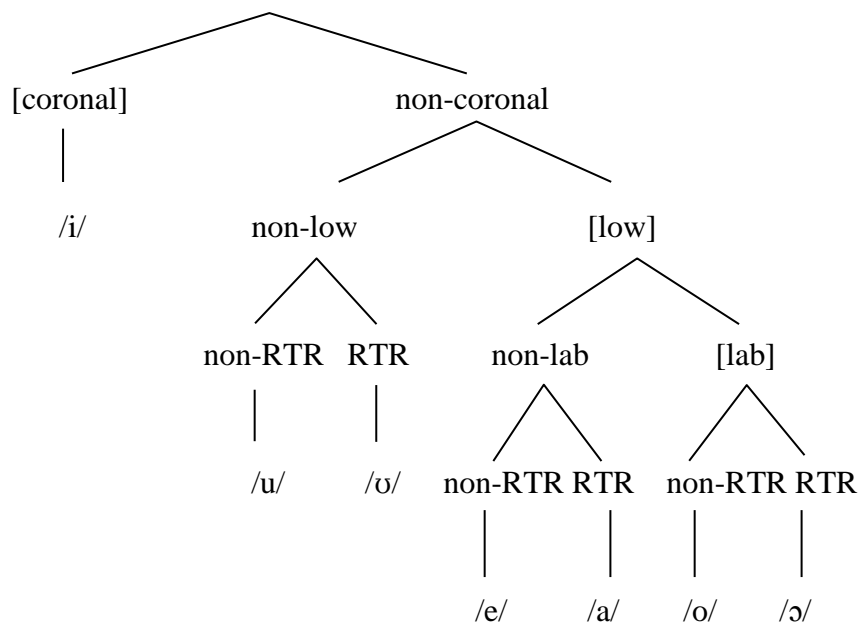

<sup>7</sup> The putative unmarkedness of Khalkha /i/ seems to have no phonological basis. For example, even when we accept Svantesson et al.'s view that /i/ (or more precisely, its reduced quality [i̥]) is epenthetic, it should be noted that it is not the only epenthetic vowel but one of the seven that are inserted depending on the quality of the preceding "full" vowel (Svantesson et al., 2005, pp. 1–7, 62–76).



b. Output specifications

/i/ = [+cor]

/u/ = [-cor, -low, -RTR]

/ʊ/ = [-cor, -low, +RTR]

/e/ = [-cor, +low, -lab, -RTR]    /o/ = [-cor, +low, +lab, -RTR]

/a/ = [-cor, +low, -lab, +RTR]    /ɔ/ = [-cor, +low, +lab, +RTR]

A thorough investigation reveals that four features are active in the phonology of Khalkha vowels: [coronal], [low], [labial], and [RTR]. The phonological patterns that evidence the contrastive status of the proposed features are summarized below:

(12) Evidence for the activity of the features [coronal], [low], [labial], [RTR]

- a. [coronal]: consonant palatalization; vowel umlaut
- b. [low]: behavioral differences between high and low rounded vowels  
(Only low rounded vowels trigger labial harmony,  
whereas high rounded vowels block labial harmony.)
- c. [labial]: labial harmony
- d. [RTR]: RTR harmony

First, the contrastive status of the feature [coronal] is evidenced by the palatalizing effect of the vowel /i/. However, this involves a rather complicated historical development consisting of consonant palatalization (yielding phonemic palatalized consonants) and vowel umlaut. According to Svantesson et al. (2005, p. 210), Mongolic palatalization had the following four steps in its development:<sup>8</sup>

---

<sup>8</sup> See also Hasbagana (2003, pp. 1–2).

- (13) Development of Mongolic palatalization (Svantesson et al., 2005, p. 210)
- a. Step 1: *\*i* palatalized the preceding consonant.
  - b. Step 2: Palatalized consonant phonemes were created by loss of final vowels.
  - c. Step 3. The palatalized consonant made the preceding vowel palatal.
  - d. Step 4: Consonant palatalization was lost, making the palatalized vowel phonemic.

Not all Mongolic varieties went through all four of these steps. In particular, according to Svantesson et al., Khalkha only went through the first two steps and is now at the third step at the phonetic level. Let us make this point a bit clearer with examples.

Khalkha has a distinction between plain (non-palatalized) vs. palatalized consonants.

- (14) Palatalized Cs contrast with plain Cs<sup>9</sup> (Svantesson et al., 2005, p. 26ff.)

Words with non-palatalized Cs		Words with palatalized Cs	
p <sup>h</sup> aɣ	‘splash!’	p <sup>h</sup> i <sup>h</sup> aɣ	‘plate’
aɣ	‘tight’	aɣi	‘wormwood’
cam	‘road’	čam	‘law’
saɣ	‘raft’	šaɣ	‘floor’
ax	‘elder brother’	axi	‘to advance’
am	‘mouth’	ami	‘life’

---

<sup>9</sup> Palatalized and plain consonants contrast only in words with RTR vowels (Svantesson et al., 2005, p. 28).

This palatalization is historically conditioned by a following *\*i*: e.g., *ami* ‘life’ < OM *\*amin* vs. *am* ‘mouth’ < OM *\*aman* (Svantesson et al., 2005, p. 28). This indicates that /i/ in Old Mongolian must have had a palatalizing feature specification, i.e., [+coronal], which spread onto the preceding consonants. Note that, due to the loss of the conditioning *\*i*, all we can say at this moment is that the feature [coronal] is contrastive for consonants in modern Khalkha.

This consonantal [+coronal] has the effect of palatalizing preceding vowels: when followed by a palatalized consonant, the pronunciation of /a, ʊ, ɔ/ is “changed so that the final part of the vowel becomes more [i]-like,” as in <аалъ> /a:l/ → [ä:lʲ] ‘manner’ (Svantesson et al., 2005, pp. 10–11). Note that these umlauted vowels are allophones in Khalkha. Therefore, although they are affected by the coronality of the following palatalized consonants, their own coronality does not necessarily suggest the existence of a contrastive vocalic [coronal] feature.

In other Mongolian dialects, however, they may have phonemic status. According to Sechenbaatar (2003, p. 12ff.), vowel umlaut and consonant palatalization in Mongolian dialects are alternative phenomena at the phonological level:<sup>10</sup> some dialects like Khalkha have palatalized consonants but no umlauted vowel phonemes whereas other dialects like Khorchin have umlauted vowels but no palatalized consonants (cf. Step 4 in (13)). We now may safely assume that the umlauted vowels (in the dialects which have lost palatalized consonants) have contrastive [+coronal] specifications. Since a contrastive [coronal] feature is available for vowels, the vowel /i/ may well be specified with this feature. This reasoning is supported by the synchronic palatalization by /i/ in the following examples:

---

<sup>10</sup> Janhunen (2003b, p. 185) also divides Mongolian dialects into “palatalization dialects” and “umlaut dialects.”

(15) Consonant palatalization in Khalkha (Svantesson et al., 2005, p. 50)

tʰaxʲi	тахий	‘to be bent’
jaŋxʲi	янхий	‘to be bony’
gʊwčʲi	гувчий	‘to be hollow’
ɔʎʲi	олий	‘to squint’
narʲiŋ	нрийн	‘thin’

Due to extensive vowel reduction and deletion (Svantesson et al., 2005, pp. 185–188), the original OM \**i* usually disappeared in non-initial syllables. However, there are a few cases where \**i* is kept in these positions, many of which are “expressive” verbs which “describe how something looks or sounds” (Svantesson et al., 2005, p. 50). Always preceded by a palatalized or alveopalatal consonant, the *i* in these words (written <ий> in Cyrillic Mongolian), which can be regarded as a derivative suffix with a rather vague meaning (Svantesson et al., 2005, p. 50), appears to have a synchronic palatalizing effect.

The contrastive status of [RTR] and [labial] is more directly evidenced by the vowel harmony patterns illustrated in (16) below: RTR harmony in (a) and (b), and labial harmony in (d). The example in (c) shows that /i/ patterns together with other non-RTR vowels when it is the only stem vowel.

(16) Khalkha vowel harmony: RTR and labial harmony

Non-RTR stems				RTR stems			
Nom	Inst	Abl	Gloss	Nom	Inst	Abl	Gloss
a. ed	ed-e:r	ed-e:s	‘article, item’	ad	ad-a:r	ad-a:s	‘evil spirit’
b. ud	ud-e:r	ud-e:s	‘noon, midday’	ʊd	ʊd-a:r	ʊd-a:s	‘willow’
c. id	id-e:r	id-e:s	‘strength, energy’				

d. od    od-o:r od-o:s ‘feather’                      ɔd    ɔd-ɔ:r ɔd-ɔ:s ‘star’

Evidence for the contrastive status of [low] also comes from the labial harmony pattern. Note that only low rounded vowels (/o, ɔ/) trigger labial harmony (c), which indicates that these vowels are contrastively [+labial].<sup>11</sup> On the other hand, high “rounded” vowels (/u, ʊ/) do not trigger labial harmony (b). Thus, we cannot be sure whether /u/ and /ʊ/ are phonologically [+labial] or not.

Interestingly, /u/ and /ʊ/ block [+labial] spreading, as illustrated in (17) below. Kaun (1995) ascribes this blocking effect to the difference in height between high (/u, ʊ/) and low rounded vowels (/o, ɔ/).<sup>12</sup> This is another piece of evidence that a height feature, [low], plays an active role in Khalkha. To be exact, /u/ and /ʊ/ must be specified for [-low].

(17) High “rounded” vowels, /u/ and /ʊ/, block labial harmony (Svantesson et al., 2005, p. 51)

Direct Past /-IE/	Causative-Direct Past /-UI-IE/	Gloss
a. uz-ʒe:	uz-u:ʒ-ʒe:	‘to see’
xʊni-ʒa:	xʊni-ʊ:ʒ-ʒa:	‘to pleat’
b. og-ʒo:	og-uʒ:-ʒe: (*og-u:ʒ-ʒo:)	‘to give’
ɔr-ʒɔ:	ɔr-ʊ:ʒ-ʒa: (*ɔr-ʊ:ʒ-ʒɔ:)	‘to enter’

<sup>11</sup> According to Kaun (1995), the phonetic motivation of labial harmony is the weak perceptibility of [labial] in low vowels (\*LoRd). So, perceptually “bad vowels spread” so that they can be exposed longer to the listeners, enhancing the perceptibility.

<sup>12</sup> Alternatively, we might simply assume that the Khalkha labial harmony is a “height-stratified” harmony (Mester, 1986). If this alternative view is correct, the roundedness of high vowels has nothing to do with the blocking effect. See §4.2.3.5 for further discussion.

Unlike the opaque vowels (/u, ʊ/), /i/ is transparent to labial harmony as well as RTR harmony as illustrated in (18). I take this as evidence that /i/ lacks contrastive [low] and [RTR] specifications.

(18) /i/ is transparent to RTR & labial harmony (Svantesson et al., 2005)

Non-RTR words	RTR words
a. de:l̥-ig-e: ‘gown-ACC-REFL’	ʃa:s-ig-a: ‘paper-ACC-REFL’
b. bi:r-ig-e: ‘brush-ACC-REFL’	
c. su:l̥-ig-e: ‘tail-ACC-REFL’	mʊ:r-ig-a: ‘cat-ACC-REFL’
d. bo:r-ig-o: ‘kidney-ACC-REFL’	xɔ:l̥-ig-ɔ: ‘food-ACC-REFL’

The examples in (18)a and (18)c show that /i/ is transparent to RTR harmony, although it takes a non-RTR suffix if it is the only vowel in a stem (b). Unlike the other high vowels /u, ʊ/, /i/ is transparent to labial harmony. This contrast between /i/ vs. /u, ʊ/ with respect to labial harmony will be discussed in §4.2.3.5.

The first cut by the feature [coronal] makes a distinction between /i/ and all the other vowels. Since there is only one [+coronal] vowel, we do not need any further specification for /i/. This explains the transparency of /i/. The vowel /i/ lacks a contrastive [-RTR] specification, although it is phonetically a non-RTR vowel. Thus it is transparent to RTR harmony. Similarly, /i/ lacks a contrastive [-low] specification, although it is phonetically a high vowel. Therefore, it is transparent to labial harmony which is blocked only by a phonologically high vowel.<sup>13</sup>

---

<sup>13</sup> This analysis of the transparency of vowels in Khalkha (and generally in Mongolic languages) has an important implication for Tungusic. It is well-known that, although the two languages show remarkably similar vowel harmony patterns, there is a minimal difference: Mongolic /i/ is transparent, whereas Tungusic /i/ is opaque to labial harmony. This can be captured by the same generalization that accounts for why low vowels trigger/undergo labial harmony while high vowels block it. The difference in the

The second cut is made by [low] and the third cut is made by [labial]. The relative ordering between these two whereby [low] takes scope over [labial] ensures that the [labial] specification is limited to low vowels: the high rounded vowels, /u/ and /ʊ/, are specified for [-low], but not specified for [+labial] even though they are phonetically rounded. This is consistent with our observation that there is no positive phonological evidence in support of the roundedness of these vowels. Recall that these vowels do not trigger labial harmony.

The last cut is made by [RTR], which ensures that a minimal contrast holds between the RTR harmonic pairs, /u/~ʊ/, /e~/a/, and /o~/ɔ/.

Note that the proposed contrastive hierarchy predicts exactly the same vowel classes attested in the suffix alternations: (i) the coronal vowel /i/ as in, e.g., the accusative marker *-ig-* in (18); (ii) non-low vowels /u~/ʊ/ as in, e.g., the causative marker *-u:ḡ-/ʊ:ḡ-* in (17); and (iii) low vowels /e~/a~/o~/ɔ/ as in, e.g., the instrumental and ablative markers in (16).

All other varieties of Mongolian Proper, e.g., Chakhar and Baarin, despite differences in their vowel inventories, fall under the same contrastive hierarchy, as will be shown in the following section.

### **2.2.1.2. Other Mongolian dialects**

The contrastive hierarchy analysis of the Khalkha vowel system can be applied to other Mongolian dialects with the same set of contrastive features and the same ordering. Mongolian dialects have different vowel inventories due to the

---

phonological behavior of /i/ between Mongolic and Tungusic is due to the difference in the contrastive hierarchy between the two language families, [coronal] > [low] in Mongolic vs. [low] > [coronal] in Tungusic. Mongolic /i/ is not contrastively high and therefore transparent; but Tungusic /i/ is contrastively high and thus opaque. See Chapter 5 for the details.

phonologization of vowel umlaut and vowel splits. For instance, new front vowels have been created as a result of umlaut in Shuluun H $\ddot{o}$ h Chakhar, a Southern Mongolian dialect, which is considered to be the standard Inner Mongolian dialect. Also, Chakhar seems to have undergone a vowel split whereby the Old Mongolian \**i* has split into two phonemes, /i/ and /i/. These changes in the vowel inventory, however, do not require any change in the contrastive hierarchy. All of the secondary umlauted vowels can be incorporated into the vowel system without adding any contrastive feature or changing the ordering among features. The result is, as given in (19), a more balanced and symmetric vowel system, making a (nearly) full use of all given features. This can be understood in terms of the notion of *feature economy* (Clements, 2003).<sup>14</sup>

(19) Shuluun H $\ddot{o}$ h Chakhar (a Southern Mongolian dialect)

a. Vowel phonemes<sup>15</sup> (Daobu [Dobo], 1983):

i	y	u	
ɪ	ʏ	ʊ	
e	ø	ə	o
ɛ	œ	a	ɔ

---

<sup>14</sup> *Feature economy* is defined as the tendency to maximize the economy index *E* which is calculated by the expression  $E = S/F$  where *S* and *F* denote the number of speech sounds and the number of features in a given sound system (Clements, 2003, p. 289). As is clear from the expression, there are two ways to obtain an increase in economy: “either by increasing the number of speech sounds in the system or by decreasing the number of features.” The *E* value for Khalkha is 1.75 (= 7/4) whereas the *E* values for Chakhar, Juu Uda, and Baarin are 3.5 (= 14/4), 2.5 (= 10/4), and 2.75 (= 11/4), respectively.

<sup>15</sup> The phonemic status of the additional front vowels [y, ʏ, e, ø, ɛ, œ] in Chakhar is questionable: [y] and [ʏ], included in Dobo (1983), are simply excluded from the inventory in Svantesson (1985); [e] and [ø] seem to have only long variants and appear only in non-initial syllables; [ɛ] and [œ] are rather umlauted allophones of their corresponding back vowels. See Svantesson (1985, p. 289) for more details. I adopt Dobo’s system, not because I believe his system is more correct than others, but because it is more useful in demonstrating how the same contrastive hierarchy analysis can apply to different dialects. Also note that /ə/ is the non-RTR counterpart to /a/ in Chakhar. It corresponds to Khalkha /e/.



b. SDA: [coronal] > [low] > [labial] > [RTR]

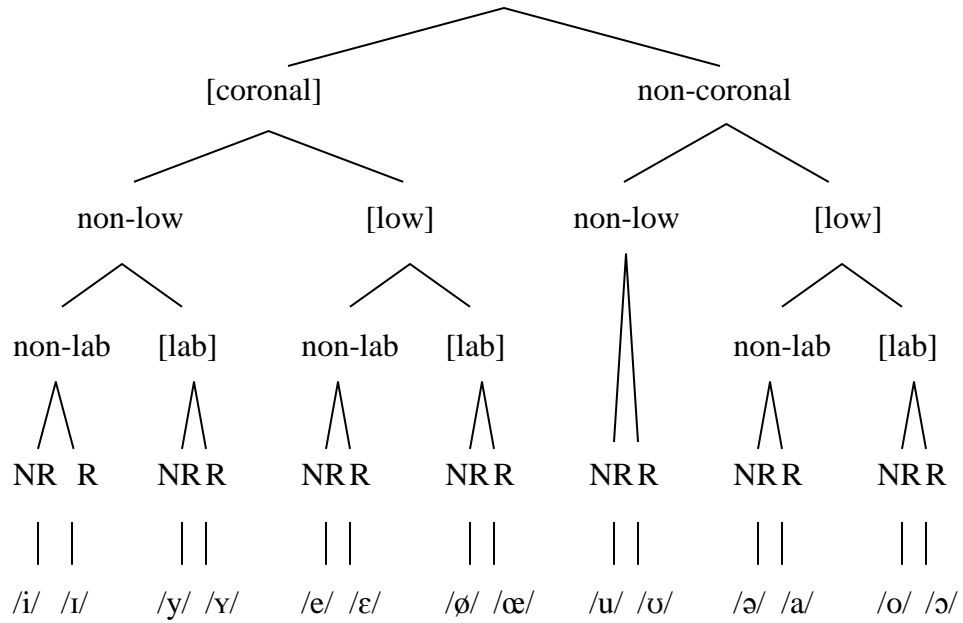

c. Output specification:

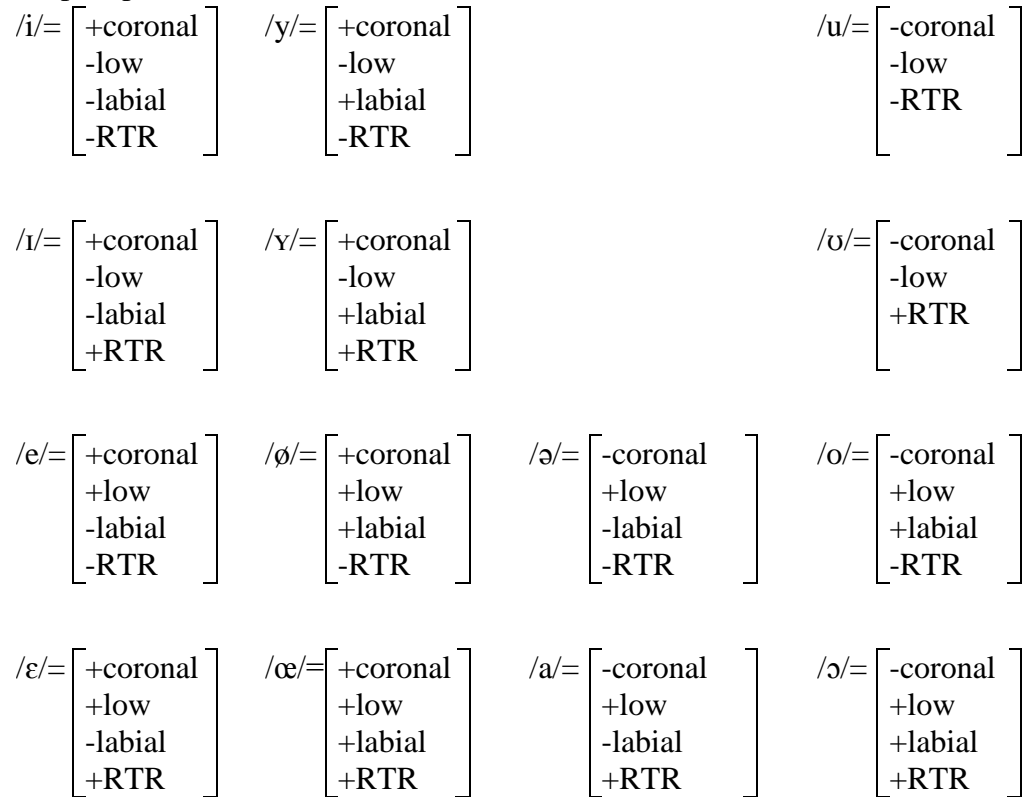

The vowel harmony patterns in Chakhar are similar to those in Khalkha (Svantesson, 1985). Chakhar has an RTR harmony that shows more regularity than Khalkha RTR harmony in the sense that the former has /i/, the RTR counterpart to /i/, instead of having a neutral vowel. The vowel /i/ appears in [-RTR] contexts, while the vowel /ɪ/ appears in [+RTR] contexts: e.g., *gər-i:g* ‘house-ACC’ vs. *gar-ɪ:g* ‘hand-ACC’ (Kaun, 1995, p. 54). Chakhar also has labial harmony.<sup>16</sup> The triggering/blocking conditions of labial harmony are the same: /i/ (and /ɪ/ as well) is transparent to labial harmony, but intervening high rounded vowels block labial harmony.

(20) Transparency and opacity in Chakhar labial harmony (Kaun, 1995, p. 57)

- a. /i/ and /ɪ/ are transparent to labial harmony

tomr-i:xo: \*tomr-i:xə: ‘iron-REFL.GEN’

gət-ɪ:xə: \*gət-ɪ:xa: ‘town-REFL.GEN’

- b. /u/ and /ʊ/ are opaque to labial harmony

ɔr-ɔ:d \*ɔr-a:d ‘enter-PERF’

ɔr-ʊ:l-a:d \*ɔr-ʊ:l-ɔ:d ‘enter-CAUS-PERF’

Chakhar seems to have both unlauded vowels and palatalized consonants, positioning itself somewhere between typical palatalization dialects, e.g. Khalkha, and typical umlaut dialects, e.g. Juu Uda. (Janhunen, 2003b, pp. 185–9; Sechenbaatar, 2003, p.

---

<sup>16</sup> Kaun (1995, p. 55ff.) points out as a “surprising” fact that the front low unrounded vowels /e, ɛ/ in Chakhar are not subject to labial harmony, even though they have rounded counterparts /ø, œ/ and thus are expected to participate in labial harmony. Instead, they show a two-way alternation as in the case of the comitative suffix: e.g., *obs-te*: (\**obs-tø*:) ‘grass-COM,’ *ɔd-te*: (\**ɔd-tæ*:) ‘star-COM.’ It is a bit unclear whose description she relies on (possibly Svantesson 1985). However, in Sechenbaatar (2003), all “front low vowel” suffixes seem to have three- or four-way alternations: e.g., *garte*: ‘hand-COM’ (< \**gar-tai*), *gerte*: ‘house-COM’ (< \**ger-tei*), *goltæ*: ‘river-COM’ (< \**gol-toi*), *mortø*: ~ *morte*: ‘road-COM’ (< \**mör-töi*).

13), although the phonemic status of umlauted vowels and palatalized consonants is not uncontroversial.

Other inner Mongolian dialects have similar vowel systems comparable to that of Khalkha or Chakhar, although there are variations in terms of the phonemic status of palatalized consonants and/or umlauted vowels. For example, the Juu Uda dialect has the following vowel system with no consonant palatalization (Janhunen, 2003b).

(21) Juu Uda phonemes (adapted from Janhunen, 2003b, p. 188 with modification)

i	y	u	
			ʊ
		ə	o
ɛ	æ	a	ɔ

The Baarin dialect of Baarin Right banner also has a very similar vowel system, with an additional /ɣ/.

(22) Baarin phonemes (Sun, Zhaonasitu, Chen, Wu, & Li, 1990; Svantesson et al., 2005, p. 144)

i	y	u	
			ʊ
		ə	o
ɛ	æ	a	ɔ

These eastern dialects show some variations, with partial paradigms of umlauted vowels that are all subsets of the inventory of Chakhar, the richest system as proposed in Dobo (1983). However, their original (non-umlauted) vowels are the same as in

Khalkha and Chakhar. They also have vowel harmony of the same type as well. Thus, I propose the same contrastive hierarchy [coronal] > [low] > [labial] > [RTR] for these Eastern Mongolian dialects.

### **2.2.1.3. Why does the feature hierarchy matter? A note on Steriade 1987**

Steriade's (1987) analysis of Khalkha vowel harmony reveals the importance of the feature hierarchy in phonological patterning.

Steriade (1987) distinguishes two types of predictable values: R(edundant)-values and D(istinctive)-values.<sup>17</sup> An R-value is a redundant value that is fully predictable from featural co-occurrence constraints and introduced by an R-rule. The classic example of an R-value is [+voice] on sonorants: [+voice] is underspecified in the underlying representation of sonorants and introduced later by a redundancy rule ([+sonorant] → [+voice]). By contrast, a D-value is a contrastive value that is predictable by the opposite value being present underlyingly. An example is the [-voice] on obstruents in a language with a voicing contrast among obstruents, when we assume that [+voice] is specified for voiced obstruents. Steriade's proposal is that R-values are missing (underspecified), but D-values (both + and -) should be specified in the Underlying Representation (UR). However, Steriade identifies strong cases which indicate that D-values may be missing underlyingly, one of which is the case of Mongolian labial harmony.

(23) Mongolian (Khalkha) vowel system (Steriade, 1987, p. 355)

---

<sup>17</sup> For more precise definitions, see Steriade (1987, pp. 341–2).

	-round	+round	
+high	i	u	+ATR
		ʊ	-ATR
-high	e	o	+ATR
	a	ɔ	-ATR

When it comes to the transparency of /i/ to ATR harmony, the distinction between D-values and R-values works as expected. Since /i/ does not have a non-ATR counterpart in the inventory, its [+ATR] value is missing in the UR. Therefore, /i/ is transparent when harmony applies. The [+ATR] R-value of /i/ is assumed to be introduced later by an R-rule.

Unlike ATR harmony, however, labial harmony poses serious problems. Steriade assumes that Mongolian labial harmony operates only between non-high vowels as schematized in (24)a. If there is an intervening high vowel, it may be either transparent (24)b or opaque (24)c, depending on the presence/absence of the [round] value for the intervening vowel when harmony applies. Thus, ideally, the transparent vowel /i/ should have an R-value for [round], whereas the opaque vowels /u/ and /ʊ/ should have a D-value for [round].

(24) Mongolian labial harmony (Steriade, 1987, pp. 356–7)

a. spreading

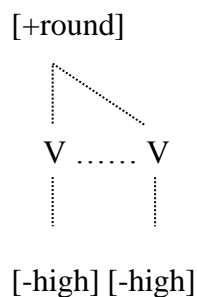

b. transparent vowel

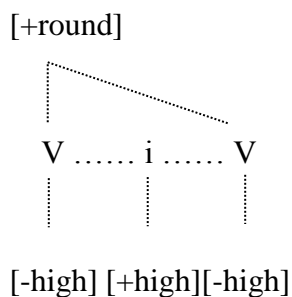

c. opaque vowel

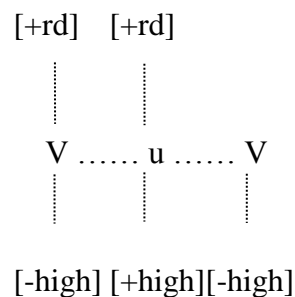

However, the actual specifications according to the analysis in (23) are the opposite: /i/ (as well as /u/) has a D-value since /i/ and /u/ contrast with each other with respect to [round], while /ʊ/ with no [-round] counterpart has an R-value for [round]. Thus, it is predicted that only /ʊ/ would be transparent whereas /i/ and /u/ would be opaque to labial harmony. This makes the wrong predictions for /i/ and /ʊ/.<sup>18</sup>

The problem can be solved if we introduce a feature hierarchy which will group the vowels properly. Let us assume that there is no palatalization or vowel umlaut by /i/.<sup>19</sup> Then, the three features used by Steriade will suffice to distinguish all the vowels and explain all the remaining vowel patterns in Khalkha. When we rank these three features correctly, the high vowels will be divided into the unrounded vowel /i/ vs. rounded vowels /u, ʊ/.

---

<sup>18</sup> Confronted with this problem, we may want to assume the following rule ordering which Steriade (1987) presents as an (undesirable) option.

R-rule precedes D-rule:

- a. R-rule: [+high, -ATR] → [+round]
- b. Labial harmony
- c. D-rule: [ ] → [-round]

This solution is based on the stipulation that “the relative order of R-values and D-values is a language specific matter” (Steriade, 1987, p. 357). The R-rule first introduces the [+round] value for /ʊ/. Then, when labial harmony applies, this [+round] value of /ʊ/ blocks the spreading of [+round]. /i/ is transparent to labial harmony because its (and all other unrounded vowels’) D-value for [round] (= [-round]) is not yet introduced at this point due to the rule ordering. After harmony applies, the D-rule introduces the D-value, [-round], for /i/ and all other unrounded vowels. As Steriade notes, however, this solution undermines the central tenet of her underspecification theory, that only R-values are systematically absent from UR: it requires a present R-value ([+round] for /ʊ/) as well as a missing D-value ([-round] for /i/). Indeed, Steriade does not pursue this solution which relies on the Mongolian-specific order between R-value [+round] and D-value [-round]. Rather, she holds that Mongolian illustrates “trivial underspecification for [round]” due to its *privative* nature, “rather than the non-trivial absence of D-values” (Steriade, 1987, p. 357).

<sup>19</sup> Thus, the contrastive hierarchy in (25) cannot be viewed as the correct one for Khalkha.

- (25) A feature hierarchy analysis based on Steriades's three features: [high] > [round] > [ATR]

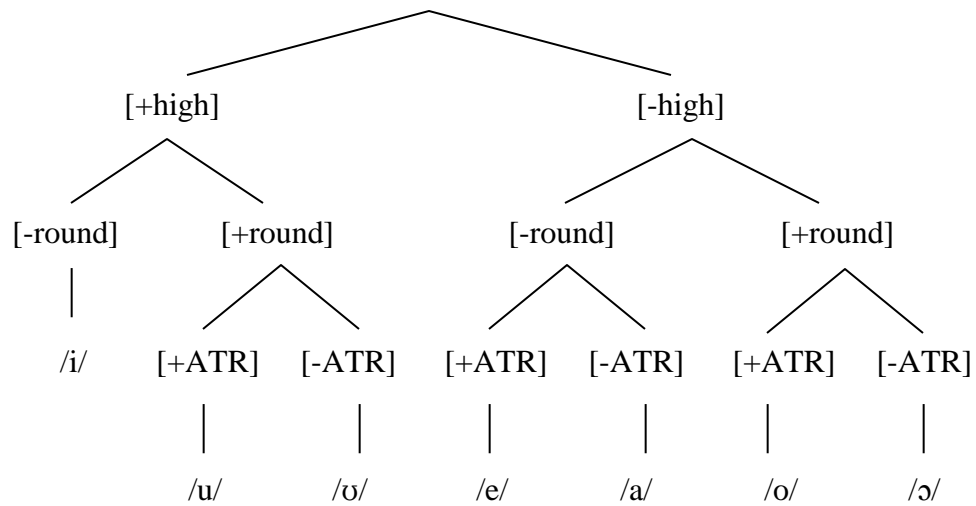

Once we have this correct grouping (/i/ vs. /u, ʊ/), there are many ways to make /i/ invisible while maintaining the visibility of /u, ʊ/ to labial harmony (see Chapter 5 for further discussion).

### 2.2.2. Type II: Monguor type languages

The second type comprises the Monguor type languages (Svantesson et al., 2005, p. 190). Monguor type languages include most Mongolic varieties spoken in the Gansu-Qinghai complex such as Monguor, Santa (S. S. Kim, 2003), and Bonan (Hugjiltu [Kögjiltü], 2003),<sup>20</sup> and the Western Mongolic language, Moghol (Weiers, 1972), spoken in Afghanistan. These languages have undergone the merger between RTR harmonic pairs (merger by RTR neutralization), OM *\*u*, *\*ᠤ* > /u/, OM *\*o*, *\*᠎* > /o/.

(26) Main reflexes of short Vs in initial syllables (cf. Svantesson et al., 2005, p. 180)

Old Mong <sup>21</sup>	*a	*᠎	*ᠤ	*ᠢ	*o	*u	*i
Khalkha	a	᠎	ᠤ	e	o	u	i
Monguor	a	o	u, o	i, e	o, u	u	i
Bonan	a	o	u	ᠢ, e	o	u	i
Santa	a	o	u	ie, ᠢ	o	u	i
Moghol	a, o	o	u	e	o	u	i

The diagram shows a solid line with four upward-pointing arrows originating from the Moghol row and pointing to the corresponding columns in the Monguor, Bonan, and Santa rows. A dashed line also originates from the Moghol row and points to the first 'o' in the Monguor row.

As a result, these languages have a reduced 5-vowel system, typified by (27).

<sup>20</sup> Other “Gansu-Qinghai” varieties, Shira Yugur and Kangjia, seem to hold an intermediate position between Type I and Type II languages (Nugteren, 2003), as we will see later.

<sup>21</sup> The RTR contrast-based reconstruction of Old Mongolian vowels presented here is far from the conventional, palatal contrast-based one. It will be justified in §2.3.



(27) The typical vowel system of Monguor type languages

i      u  
       ə<sup>22</sup> o  
       a

Due to insufficient data and description of the relevant phonological patterns, it is difficult to establish contrastive hierarchies for Monguor type languages with confidence. However, the following contrastive hierarchy in (28), which is basically the same as that of Khalkha type languages except for the loss of [RTR], seems consistent with the known facts.

(28) Contrastive hierarchy for Monguor type languages

a. SDA: [coronal] > [low] > [labial]

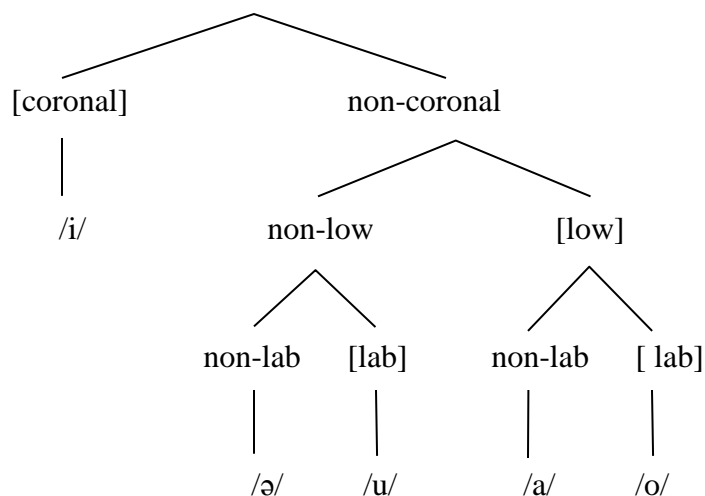

<sup>22</sup> It may be the case that /ə/ in certain Monguor type language such as Monguor has been reinterpreted as a front vowel /e/. See Monguor in §2.2.2.1.

b. Output specifications:

/i/ = [+cor]	/ə/ = [-cor, -low, -lab]	/u/ = [-cor, -low, +lab]
	/a/ = [-cor, +low, -lab]	/o/ = [-cor, +low, +lab]

Unlike Khalkha type languages, there is no contrastive [RTR] feature in the hierarchy. This is because Monguor type languages do not display rigorous RTR harmony as a synchronic phonological rule. However, it should be noted that there is a phonemic distinction between velar and uvular consonants which can be characterized as a contrast between [-RTR] consonants vs. [+RTR] consonants.<sup>23</sup> This indicates that [RTR] was once contrastive for vowels at an earlier stage. The original allophonic distinction between velar vs. uvular consonants became phonemic as a result of the loss of vowel contrasts based on [RTR] (Svantesson et al., 2005).

The evidence for the loss of [RTR] is summarized below:

- (29) Evidence for the loss of [RTR] (Janhunen, 2003e; Svantesson et al., 2005):
- a. No vowel harmony (Monguor, Bonan, and Moghol) or only remnants of vowel harmony (Santa)
    - cf. Shira Yugur, Kangjia, where the vowel harmony pattern is retained.
  - b. Phonemic velar-uvular distinction (Monguor, Santa, Bonan, Moghol) which is historically conditioned by non-RTR vs. RTR vowel contrast at an earlier stage
  - c. Vowel mergers: OM \*u, \*ʊ > u, OM \*o, \*ɔ > o.

---

<sup>23</sup> According to Nevins (2010, pp. 92–93), “velar/uvular alternations induced by vowels may be conditioned by [±low], [±high], or [±ATR],” depending on which feature the particular language independently activates. It should be noted that [±back] is irrelevant to the velar vs. uvular distinction. For example, in Yakut (Turkic) which has a Turkish-like eight-vowel system with palatal harmony, uvularization is triggered by low vowels, not by back vowels.

Now let us look at the details of the vowel contrast and the vowel-related phonological patterns in each language of the second type.

### 2.2.2.1. Monguor

Monguor (White Mongol; Tuzuyu 土族語) is spoken in the easternmost part of Qinghai province, mainly in Huzhu and Minhe counties (Svantesson et al., 2005, p. 151). Although it has been suggested that Huzhu Monguor (Mongghul) and Minhe Mongguor (Mangghuer) should be treated as separate languages due to large dialectal differences (Slater, 1998, 2003a, 2003b), their vowel phonemes seem to be identical (Qasbagatur, 1986; Qingge’ertai [Cenggeltei], 1991; Slater, 2003a, 2003b).

(30) Monguor vowel phonemes (Svantesson et al., 2005, p. 152)

i	u
e	o
a	

Although the vowel /e/ is normally described as a mid “front” unrounded vowel (e.g., Chuluu, 1994a, pp. 2–3; Slater, 2003b, pp. 32–36), it seems that /e/ is realized as [ə] in general and only contextually realized as “front” (= [ɛ]) before or after a palatal consonant in Mangghuer (Slater, 2003b, p. 33).

It is simply said that Monguor has lost vowel harmony (Svantesson et al., 2005, p. 152).<sup>24</sup> A trace of vowel harmony is only found in the contrast between the velar and the uvular stops.<sup>25</sup> Without any further evidence available, I assume that Monguor

---

<sup>24</sup> However, see Qingge’ertai (1991) for some residual harmony phenomena.

<sup>25</sup> The distribution of the velar and the uvular stops is fairly consistent in Mongghul: “[g] (= [k]) before /e, i/, before /o, u/ with /\*ö, \*ü/ origin, and before /a/ in Chinese/Tibetan loanwords, whereas [gh] (= [q])

used to exploit the same contrastive features as other Mongolic languages, [coronal], [labial], [low], and [RTR] at an earlier stage, and has lost the RTR contrast. This loss of [RTR] from the contrastive hierarchy is well attested in other Altaic languages: Middle Korean (§3.2) and Written Manchu (Dresher & Zhang, 2005). (31) shows the contrastive hierarchy for Monguor.

(31) Monguor contrastive hierarchy

- a. SDA: [coronal] > [low] > [labial]

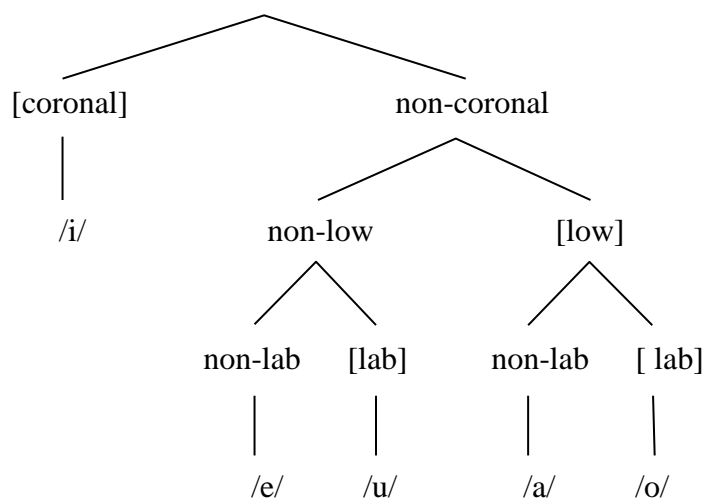

- b. Output specifications:

/i/ = [+cor]	/e/ = [-cor, -low, -lab]	/u/ = [-cor, -low, +lab]
	/a/ = [-cor, +low, -lab]	/o/ = [-cor, +low, +lab]

Unlike Khalkha /e/, Monguor /e/ should not be treated as a low vowel, considering the vowel devoicing reported in Mangghuer. According to Slater (2003b, pp. 36–37), Mangghuer has an optional vowel devoicing whereby /i, e, u/ are devoiced when

---

before /o, u/ with /\*o, \*u/ origin, and before /a/ in native words” (Georg, 2003, p. 291). Mangghuer also retains the uvular stops (Slater, 2003a, p. 310).

followed by a voiceless consonant. This indicates that all three of these vowels need to be grouped together in such a way that they are distinguished from /a, o/. The contrastive hierarchy in (31) provides such a way: vowels can be grouped into those that are specified for [+low] and those that aren't.

According to Slater (Slater, 2003a, 2003b), Mangghuer seems to have developed a phonemic distinction between palatal consonants /tɕ, tɕʰ, ɕ/ and retroflex consonants /tʂ, tʂʰ, ʂ/, maybe due to Chinese influence. Basically, the original OM \*dʒ (= \*č in Svantesson's system), \*ʃ (= \*čʰ), and \*s became palatal when followed by a front vowel but retroflex when followed by a non-front vowel. Interestingly, Slater claims that all front vowels, that is, both /i/ and [ɛ] (the front allophone of /e/), pattern together as the historical context for the palatal consonants. Here are Slater's examples for /tɕ/ vs. /tʂ/.

(32) Palatal /tɕ/ vs. retroflex /tʂ/ (Slater, 2003b, p. 46)

	Monguor	Orthography <sup>26</sup>	W.Mong <sup>27</sup>	Gloss
a. Palatal	[tɕɛ'ljɛ]	<i>jielie</i>	<i>ǰigelekü</i>	'to borrow'
	[ɕ-tɕɛ'kə]	<i>erjige</i>	<i>elǰige</i>	'donkey'
	[paja'tɕɛ]	<i>bayaji</i>	<i>bayajiqu</i>	'rich'
b. Retroflex	[tʂa'lə]	<i>zhaler</i>	<i>ǰalayü</i>	'strong young man'
	[tʂwə'kaj]	<i>zhuergai</i>	<i>ǰirüxe</i>	'heart'
	[qa'tʂə]	<i>ghazher</i>	<i>ǰajar</i>	'ground'

<sup>26</sup> This orthography is based on the Chinese pinyin romanization system. See Slater (2003b, pp. 53–54) for further details.

<sup>27</sup> Written Mongolian forms are added by the author.

If Slater's observation is correct, we might need a revision of the proposed contrastive hierarchy as follows:<sup>28</sup>

(33) Monguor contrastive hierarchy: [coronal] > [low] > [labial] (Based on Slater)

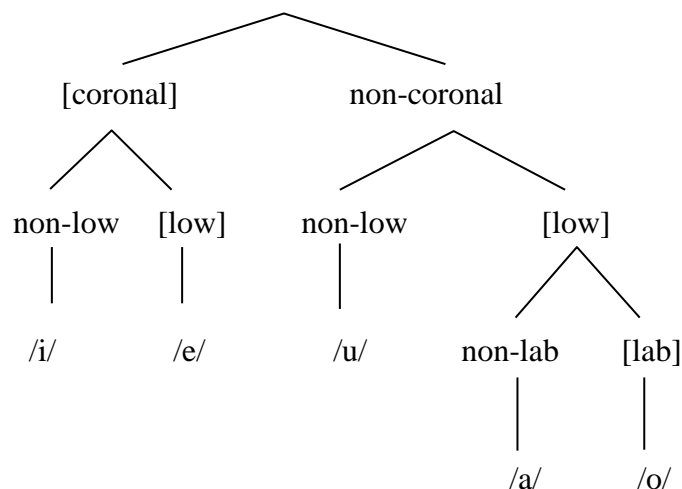

However, as both the orthographic forms and the Written Mongolian forms suggest, the palatals seem to be conditioned only by the high front vowel /i/ (see also Poppe, 1955, for a parallel approach to Mongghul). The [ɛ] in *jielie* ‘to borrow’ in particular appears more likely to be the effect rather than the cause of the palatalization.

Nonetheless, despite the slight difference in the feature specification of /e/, both the analyses in (31) and (33) serve my purpose: they share the same contrastive features and hierarchy with the loss of [RTR] from the hierarchy at an earlier stage.

---

<sup>28</sup> Or we may need to assume that the contrastive hierarchy analysis in (33) represents an earlier stage of Monguor when the split into the two series occurred.

#### 2.2.2.2. Santa (Dongxiang)

Santa (Dongxiang), spoken in the southwestern area of Gansu province, has the following vowel system.

(34) Santa vowel phonemes (S. S. Kim, 2003, p. 348)

i	u
ə	o
a	

Svantesson et al. (2005, p. 152), based on Böke (1983, 1986), presents six vowel phonemes /i, u, ə, o, a/ for Santa.<sup>29</sup> However, the “normal” pronunciation of /e/, according to Kim (2003, p. 348), is the mid central unrounded vowel [ə]. This is also confirmed by Liu (1981, p. 6), Sun et al. (1990, p. 81), Chuluu (1994b, p. 2), and Field (1997, p. 37) where /ə/ replaces /e/ in the vowel inventory. Kim (2003, p. 348) also regards [u] as an allophone of /i/ and eliminates it from the inventory, based on the observation that [u] is in complementary distribution with [i], occurring mainly after the uvular consonants.<sup>30</sup>

There is only limited information on the activity of phonological features. First, there seems to be palatalization triggered by /i/ (Field, 1997, pp. 40–41; Sun et al., 1990, p. 82). Although palatalization is basically historical, Field (p. 40, fn. 19) impressionistically notes that the “rule is still productive,” since “any new loans would

---

<sup>29</sup> Field (1997) presents another vowel phoneme /ɤ/, which is very rare. From the only two words of Mongolic origin that contain this vowel, Field notes that the vowel /ɤ/ corresponds to /r/ in Old Mongolian and other Mongolic varieties.

<sup>30</sup> According to other published descriptions, [u] is also found after aspirated stops (/p<sup>h</sup>, t<sup>h</sup>, k<sup>h</sup>/) as well as uvulars (/q<sup>h</sup>, q, ʁ/) (Field, 1997, p. 52), and after retroflex consonants borrowed from Chinese (Sun, Zhaonasiu, Chen, Wu, & Li, 1990, p. 81).

undergo the same palatalization rule.” Second, vowel harmony has been lost or there are only remnants of RTR harmony (Buhe [Böke], 1983; Sun et al., 1990, p. 81; Svantesson et al., 2005, p. 152) with the retained velar-uvular distinction in consonants (S. S. Kim, 2003, p. 349; Sun et al., 1990, p. 82; Svantesson et al., 2005, p. 152). Also, there are remnants of labial harmony, found in suffixal allomorphy: e.g., *boro-lo-* ‘become gray,’ *noɓo(ŋ)-ro-* ‘become green,’ *golo-do-* ‘take distance,’ *olo(ŋ)-do-* ‘become more’ (Buhe [Böke], 1983, p. 25; see also Field, 1997, pp. 155–156).

Based on this limited information on the phonological patterns as well as the merger pattern we have seen in (26) (= (35) below), I propose the contrastive hierarchy in (36) for Santa, which is essentially the same as that of Monguor.

(35) Santa reflexes of OM short vowels in initial syllables (Svantesson et al., 2005)

(cf. Svantesson et al. 2005: 180)

Old Mong	*a	*ɔ	*ʊ	*e	*o	*u	*i
Santa	a	<span style="border: 1px solid black; padding: 2px;">o</span>	<span style="border: 1px solid black; padding: 2px;">u</span>	ie, ə	<span style="border: 1px solid black; padding: 2px;">o</span>	<span style="border: 1px solid black; padding: 2px;">u</span>	i

(36) Santa contrastive hierarchy

a. SDA: [coronal] > [low] > [labial]

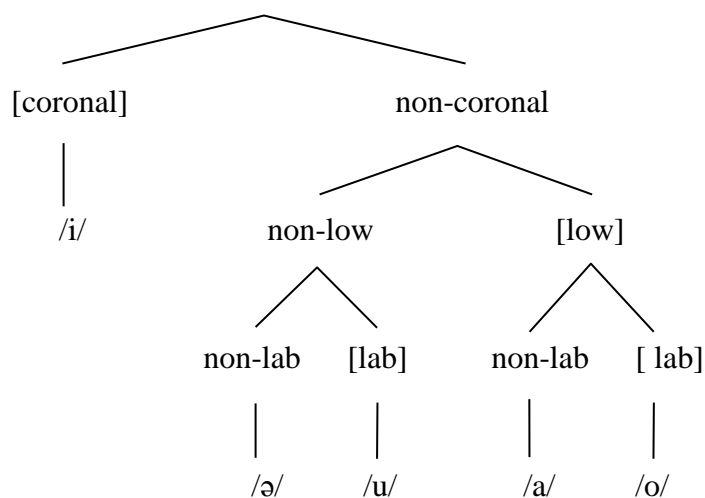



b. Output specifications:

/i/ = [+cor]                      /ə/ = [-cor, -low, -lab]                      /u/ = [-cor, -low, +lab]  
/a/ = [-cor, +low, -lab]                      /o/ = [-cor, +low, +lab]

Note in the above hierarchy that only /a, o/ are specified for [+low]. These are the vowels that do not become devoiced when surrounded by voiceless obstruents (Field, 1997, p. 45). (Recall the similar vowel devoicing in Mangghuer.)

### 2.2.2.3. Bonan

Bonan (Bao'an, Boan, Paoan, Paongan, Baonan), spoken in the Tongren area in the easternmost part of Qinghai province (Buddhist Qinghai Bonan) and in Jishishan county in the southwestern part of Gansu province (Islamic Gansu Bonan), has a similar vowel system to Santa (Hugjiltu [Köggiltü], 2003, p. 326ff.).

(37) Bonan vowel system (Hugjiltu [Köggiltü], 2003, p. 327)

i        u  
      ə    o  
      a

The above vowel system is a slight modification of Hugjiltu (2003) who uses /e/ rather than /ə/. In Tongren dialect, where vowel length is contrastive, the short /e/ is realized as [ə] and the long /e:/ as [e:] (Hugjiltu [Köggiltü], 2003, p. 327). See Chen (1986, 1987, 1990), Chuluu (1994c), Svantesson et al. (2005, p. 153), and Fried (2010, pp. 32–33) for relevant discussion.<sup>31</sup>

---

<sup>31</sup> Fried (2010), who posits six vowel phonemes with an additional /e/, assumes that Hugjiltu's /e/ [ə, e:]

The merger pattern of Bonan is the same as that of Monguor and Santa.

- (38) Bonan reflexes of OM short vowels in initial syllables (Svantesson et al., 2005, p. 180)

Old Mong	*a	*ɔ	*ʊ	*ə	*o	*u	*i
Bonan	a	o	u	ə	o	u	i

There is no vowel harmony, which indicates the currently non-contrastive status of [RTR]. Thus, I propose the following contrastive hierarchy for Bonan, which is the same as Monguor and Santa.

- (39) Bonan contrastive hierarchy

- a. SDA: [coronal] > [low] > [labial]

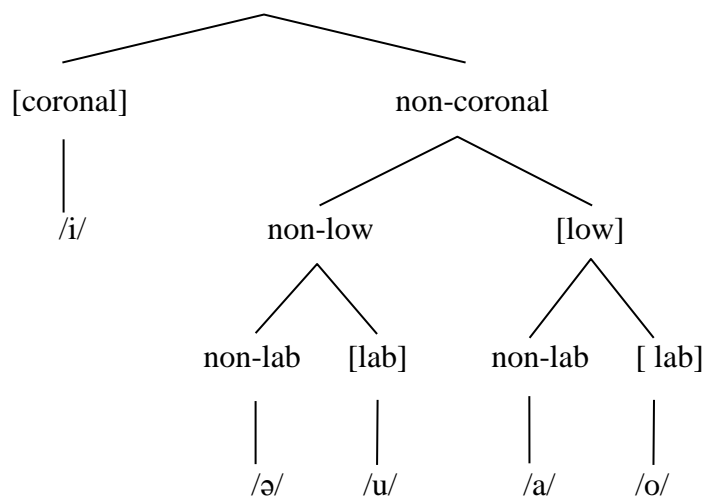

- b. Output specifications:

/i/ = [+cor]      /ə/ = [-cor, -low, -lab]      /u/ = [-cor, -low, +lab]  
 /a/ = [-cor, +low, -lab]      /o/ = [-cor, +low, +lab]

---

and /i/ [e, i:] have splitted into three distinct phonemes /ə/, /e/, and /i/ (p. 34).

#### 2.2.2.4. Moghol

Strictly speaking, Moghol is not a Gansu-Qinghai variety, but an isolated Mongolic language spoken in Herat, Afghanistan, by an estimated 200 speakers (J. Kim, Kwon, et al., 2008, p. 94f.). This language may be extinct by now.

It is usually classified on its own in most classifications proposed in the literature. It shows “a very high percentage of the borrowed Persian or Persian-Arabic vocabulary” and phonologically “reveals a strong and unambiguous influence of Tajik” (Weiers, 2003, p. 250f.). In this thesis, however, it is grouped together with the Gansu-Qinghai varieties because they show a resemblance in terms of the vowel inventory.

(40) Moghol vowel system (Weiers, 1972)

i	u
e	o
a	

Moghol does not have vowel harmony (Svantesson et al., 2005, p. 154). This is ascribed to the diachronic change (neutralization) of the vowel \*e into /a/ in all *non-initial* syllables (Weiers, 2003, p. 253).

The main reflexes of Old Mongolian short vowels in Moghol basically show the merger by neutralization between RTR harmonic pairs (Svantesson et al., 2005), although the detailed correspondences are a bit more complicated (Weiers, 1972).<sup>32</sup>

---

<sup>32</sup> Comparison between Moghol phonemes /u, o/ and Uyghur Mongolian scripts is as follows (Weiers, 1972):

Moghol /u/ < UM <o>, <ö>, <u>, <ü>  
Moghol /o/ < UM <a>, <o>, <ö>, <u>... but not <ü>

(41) Moghol reflexes of OM short vowels in initial syllables (Svantesson et al., 2005, p. 180)

Old Mong	*a	*ɔ	*ʊ	*ə	*o	*u	*i
Moghol	a, o	<span style="border: 1px solid black; padding: 2px;">o</span>	<span style="border: 1px solid black; padding: 2px;">u</span>	e	<span style="border: 1px solid black; padding: 2px;">o</span>	<span style="border: 1px solid black; padding: 2px;">u</span>	i

As is the case in Monguor, Santa, and Bonan, this merger by RTR neutralization yielded the phonemic contrast between velar and uvular consonants which had once been allophonic (Svantesson et al., 2005, p. 198). Again, the merger is consistent with the hypothesis that the feature [RTR] was at the bottom of the hierarchy at an earlier stage under the Minimal Contrast Hypothesis.

With the lack of sufficient data in the literature, I tentatively assume the following contrastive hierarchy for the Moghol vowel system.

(42) Moghol contrastive hierarchy

a. SDA: [coronal] > [labial] > [low]

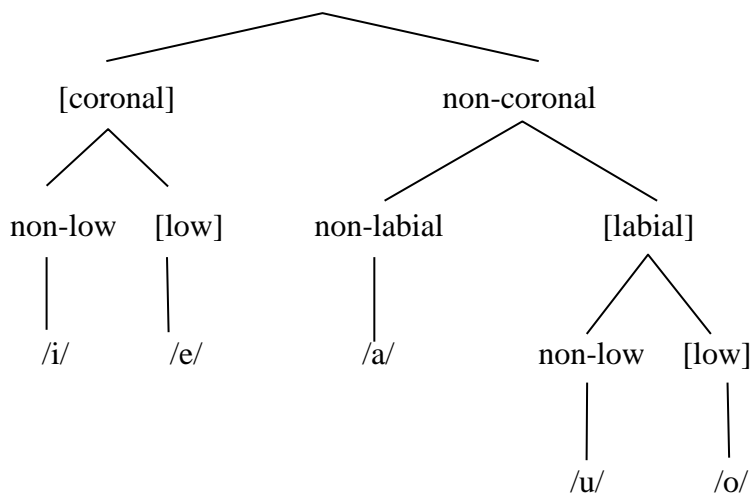

b. Output specifications:

/i/ = [+cor, -low]		/u/ = [-cor, +lab, -low]
/e/ = [+cor, +low]	/a/ = [-cor, -lab]	/o/ = [-cor, +lab, +low]

### 2.2.2.5. Shira Yugur

Shira Yugur<sup>33</sup> (Eastern Yugur; Dōngbù Yùgù in Chinese), probably the second-smallest Mongolic language in China (after Khamnigan), is spoken by approximately 3,000-4,000 speakers in the border area between Gansu and Qinghai provinces in northwestern China. It holds an intermediate position between the “central” group of Mongolic, e.g., Mongolian Proper and Oirat, and the typical Gansu-Qinghai varieties, e.g., Monguor, Bonan, and Santa (Nugteren, 2003, p. 265).

Svantesson et al. (2005, p. 151) and Chuluu (1994d, p. 2) present a 10-vowel system for Shira Yugur based on the Kangle dialect described in Bulucilagu and Jalsan (1992) and Bulucilagu (1985). In contrast, Nugteren (2003, p. 266f.) identifies only 7 phonemic vowel qualities, /i, e, a, ü, u, ö, o/.<sup>34</sup>

#### (43) Shira Yugur vowel systems previously proposed in the literature

a. Svantesson et al. (2005, p. 151)	b. Nugteren (2003, p. 266f.)
i y u	i ü u
	e ö o
e ø ɣ o	a
a ɔ	

---

<sup>33</sup> The ethnonym Yugur also includes the Sarygh Yugur (Western Yugur; Xībù Yùgù in Chinese) who speak a Turkic language. Although it is fairly clear that the name originates from the ancient Turkic ethnonym *Uyghur*, there is no evidence that the Shira Yugur are Mongolized Turkic people (Nugteren, 2003, p. 265).

<sup>34</sup> See also Junast (1981, p. 4) and Sun et al. (1990, p. 68) for a similar 8-vowel system with an additional /ə/. This /ə/ in Junast’s system, unlike all other vowels, does not have a long counterpart.

c. Chuluu (1994d, p. 2)

	front		central	back		
	-rd	+rd	-rd	+rd	-rd	+rd
high	i	y	ɯ		u	
mid	e	ø	ə		o	
low					a	ɔ

According to Nugteren (2003, p. 266f.), [ə] and [ɯ] are the realizations of short /i/ and /ü/, and [y] is the shortened realization of long /üü/. If this is correct, there does not seem to be much difference between the vowel systems in (43)b and (43)c in spite of the different symbols. However, it is still unclear how we should interpret the vowels in the system of Svantesson et al. (2005), especially /y, ø, ɤ/ in comparison. /ɤ/ may be an allophone of /i/ (the realization of short /i/), as described in Nugteren (2003). Or it may be a reduced vowel derived from /e/ and /a/, thus being neutral to vowel harmony (Svantesson et al., 2005, p. 151), possibly in non-initial position. /y/ and /ø/ could be umlauted allophones of diphthongs as they are in other Mongolic languages. However, this conjecture is yet to be confirmed.

Following Svantesson et al. (2005) in assuming an RTR-based system and Nugteren (2003) in positing 7 vowel phonemes, I present the following system for Shira Yugur, which is fairly similar to that of Mongolian Proper, especially Khalkha.

(44) Shira Yugur vowel system

i	u
	ɯ
e	o
a	ɔ

Vowel harmony, including labial harmony, in Shira Yugur has been reduced to suffixal vowel harmony (Nugteren, 2003, p. 268), whereby low vowel suffixes show alternations between /e/, /a/, and /ɔ/.<sup>35</sup>

(45) Suffixal vowel harmony in Shira Yugur (Junast, 1981, p. 12f.)

- |    |             |                    |           |                                 |
|----|-------------|--------------------|-----------|---------------------------------|
| a. | pes-eer     | ‘cloth-Inst’       |           |                                 |
|    | lar-aar     | ‘language-Inst’    |           |                                 |
|    | moor(ə)-oor | ‘horse-Inst’       |           |                                 |
| b. | derme       | ‘thief; robber’    | derme-le- | ‘to rob’ (抢)                    |
|    | biar        | ‘joy’              | biar-la-  | ‘to be pleased’ (喜悦)            |
|    | siom        | ‘span (of a hand)’ | siom-lo-  | ‘to measure using <i>siom</i> ’ |

Based on limited available data, I tentatively assume the following contrastive hierarchy, which is the same as the Khalkha contrastive hierarchy.

---

<sup>35</sup> Those allomorphs with the vowel *o*(oo) show free variation with those with the vowel *e*(ee): e.g., kol-oor~kol-eer ‘leg-Inst’. This free variation between *o* and *e* is not confined to suffixal alternation, but is also found in stems: pəs~pes ‘cloth’, møøndə~meendə ‘peace’ (Junast, 1981, p. 5).

(46) Contrastive hierarchy for Shira Yugur

a. SDA: [coronal] > [low] > [labial] > [RTR]

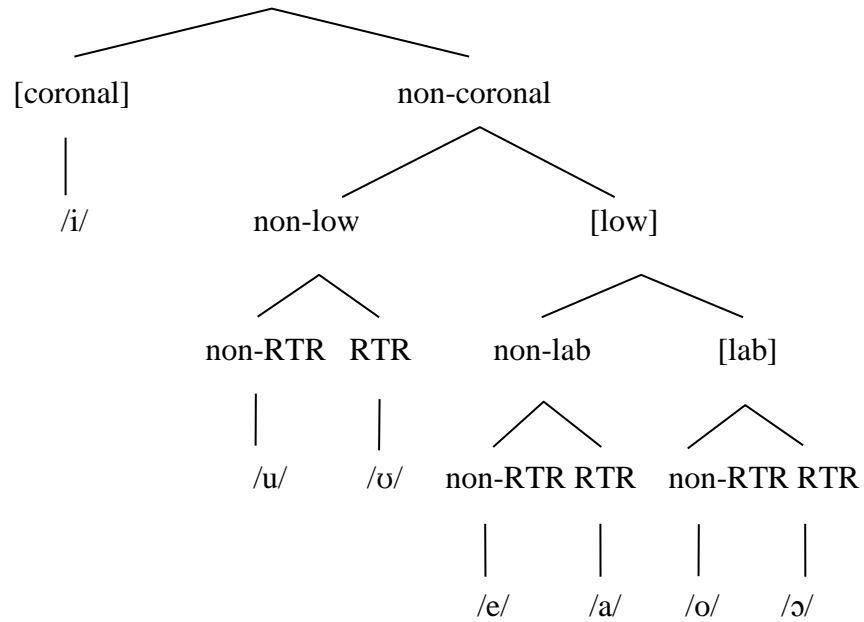

b. Output specifications

/i/ = [+cor]

/u/ = [-cor, -low, -RTR]

/ʊ/ = [-cor, -low, +RTR]

/e/ = [-cor, +low, -lab, -RTR]

/o/ = [-cor, +low, +lab, -RTR]

/a/ = [-cor, +low, -lab, +RTR]

/ɔ/ = [-cor, +low, +lab, +RTR]



### 2.2.2.6. Kangjia

The Kangjia language, a Gansu-Qinghai Mongolic variety spoken by about 400 people in the Kangyang commune in Jainca county, Qinghai province, is regarded as close to Bonan and Santa (J. Kim, Kwon, et al., 2008, p. 85), but also has phonological similarities to Shira Yugur (Svantesson et al., 2005, p. 153). One such similarity is the vowel system.

Svantesson et al. (2005, p. 153), based on Secencogtu (1999), describe the Kangjia vowel system as follows:

(47) Kangjia vowel system (Svantesson et al., 2005, p. 153)<sup>36</sup>

i	u	u
		o
e	ɤ	o
		a
		ɔ

According to Svantesson et al. (2005, p. 154), the vowels /u/ and /ɤ/ are neutral vowels like /i/. However, the phonemic status of the vowels /u/ and /ɤ/ is unclear. Also, neither of them are the main reflexes of Old Mongolian vowels (Svantesson et

---

<sup>36</sup> Secencogtu (1999, p. 22) presents the following 11-vowel system with allophones parenthesized:

	front		central		back	
	-rd	+rd	-rd	+rd	-rd	+rd
high	i	y		u	u	u
						(o)
	e			ə		(o)
mid			ə	ə		
	(ɛ)					ɔ
low						a

Although it is not clearly explained in Svantesson et al. (2005, p. 153) how this 11-vowel system corresponds to the 9-vowel system in (47), it appears that they (i) eliminated /y/ and /ə/ from the inventory and (ii) normalized other vowel symbols according to their “pharyngeal” (= RTR) analysis replacing /u/, /u/, /ə/, /ə/ with /u/, /u/, /o/, /ɤ/, respectively. /i, u, e, ɔ, a/ remain the same.

al., 2005, p. 180). Therefore, I eliminate /w/ and /ɣ/ from the phoneme inventory,<sup>37</sup> leaving the following 7 vowel phonemes.

(48) Kangjia vowel system (revised)

i	u
	ɔ
e	o
	a ɔ

Svantesson et al. (2005, p. 154) describe the Kangjia vowel harmony as pharyngeal harmony based on the opposition between pharyngeal (/a, ɔ, ʊ/) vs. non-pharyngeal (/e, o, u/) vowels. However, Kangjia only has a limited form of harmony (Siqinchaoketu [Secencogtu], 1999, p. 42f.; Svantesson et al., 2005, p. 154). This remnant harmony can be found mostly in suffixal allomorphy.

(49) RTR harmony in suffixal allomorphy in Kangjia (Siqinchaoketu [Secencogtu], 1999, p. 42f.)

a. e/a alternation: *-le/-la*

pəse 带 ‘belt’ > pəs-le 系带 ‘wear a belt’

anda 度 > anda-la 度量

b. u/ʊ alternation: *-gʊn/-ɸʊn*

de- (as in dere ‘above,’ a bound morpheme) > de-gʊn ‘upper part’

du- (as in duru ‘below,’ a bound morpheme) > du-ɸʊn ‘lower part’

---

<sup>37</sup> Considering their neutrality, it is likely that /w/ and /ɣ/ are reduced and neutralized allophones of RTR harmonic pairs, although this cannot be proven on the basis of currently available information.

Based on this limited description, I propose the following contrastive hierarchy for the Kangjia vowel system, which is indeed identical to the contrastive hierarchy of Shira Yugur (and Mongolian Proper as well).

(50) Contrastive hierarchy for Kangjia

a. SDA: [coronal] > [low] > [labial] > [RTR]

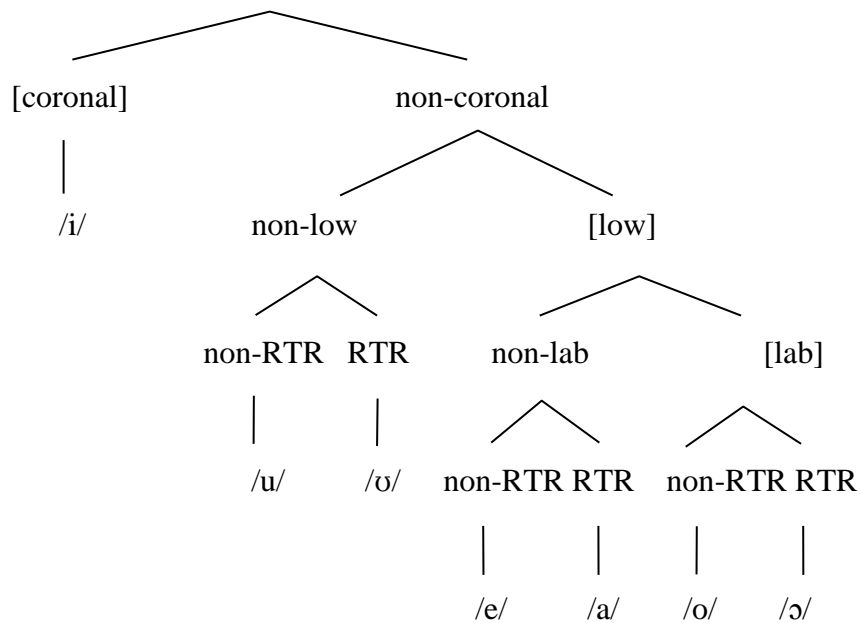

b. Output specifications

/i/ = [+cor]    /u/ = [-cor, -low, -RTR]    /ʊ/ = [-cor, -low, +RTR]  
 /e/ = [-cor, +low, -lab, -RTR]    /a/ = [-cor, +low, -lab, +RTR]  
 /o/ = [-cor, +low, +lab, -RTR]    /ɔ/ = [-cor, +low, +lab, +RTR]

### 2.2.3. Type III: Dagur type languages

The third type is what I call Dagur type languages, which includes Dagur, Khamnigan, and Buriat. The representative of this type is Dagur, the vowel system of which is seemingly identical to that of Monguor in terms of vowel inventory. However, I will show that the Dagur system is very distinct from the Monguor system when it comes to the contrastive hierarchy. The crucial difference between Type II (Monguor type) languages and Type III (Dagur type) languages is found in their merger patterns. Type II languages have undergone the merger between the RTR harmonic pairs such as /u/ and /ʊ/, and /o/ and /ɔ/. In contrast, Type III languages have undergone (or are undergoing) the merger between the high and low rounded vowel pairs such as /u/ and /o/, and /ʊ/ and /ɔ/. The latter pattern is attested in Dagur, Khamnigan, and Buriat to varying degrees, with Dagur being the most developed language in this direction. In Buriat, short /o/ merged with /u/. In Khamnigan, long /o:/ also merged with /u:/. In Dagur, /u/ and /ʊ/, short or long, merged with /o/ and /ɔ/, respectively.

(51) Main reflexes of short Vs in initial syllables (adapted from Svantesson et al., 2005, p. 180)

Old Mong	*a	*ɔ	*ʊ	*ə	*o	*u	*i
Khalkha	a	ɔ	ʊ	e	o	u	i
Buriat	a	ɔ	ʊ	ə	u	u	i
Khamnigan	a	ɔ	ʊ	ə	u	u	i
Dagur	a	ɔ	ɔ, wa	ə	u	u	i

Now let us look at the detail of each Type III vowel system with the Dagur language first.

### 2.2.3.1. Dagur

According to Engkebatu (1988, pp. 22–26), there are four main dialects of Dagur: the Buthaa, Qiqihaer, Hailaer, and Xinjiang dialects. The data used here is originally from Engkebatu (1984, 1988) who is a native speaker of Buthaa dialect.

Dagur has 5 vowel phonemes (Chuluu, 1996, p. 7; Martin, 1961, p. 15; Seong, 1999a; Seong, Kim, Ko, & Kwon, 2010, p. 37; Tsumagari, 2003, pp. 130–1).<sup>38</sup>

(52) Dagur vowel system<sup>39</sup>

i      u  
      ə  
      a    ɔ

The following is a minimal word list that shows the phonemic status of each vowel.

(53) Dagur simple vowels in monosyllabic words (Chuluu, 1996, p. 7)

/a/	al	‘kill’	xar	‘black’
/ə/	əl	‘say’	xər	‘how’
/i/	il	‘lively’	xir	‘blade’
/ɔ/	ɔl	‘get’	xɔr	‘top’
/u/	ul	‘no’	xur	‘seed’

---

<sup>38</sup> Engkebatu (1988) proposes a 6 vowel system for (Buthaa) Dagur with an additional vowel /e/. According to Yu et al. (2008), Xinjiang dialect also has a 6 vowel system. However, [e] is originated from /iə/ or /əi/ and its phonemic status is uncertain (Seong, 1999a, p. 617).

<sup>39</sup> According to Chuluu (1996, p. 7), only /i, ə, u/ can appear in non-initial syllables due to vowel reduction. This statement, however, may be better understood as a statement regarding stem-internal vowel distribution since in the suffixal harmony pattern /a/ and /ɔ/ can also occur in non-initial syllables. There are exceptions, though: e.g., *ila:n* ‘light’ in (58).

I proposed the following contrastive hierarchy for Dagur, [coronal] > [labial] > [RTR]. Three contrastive features suffice to capture the contrast between all 5 vowels. Notably, there is no [low] feature in the proposed hierarchy, compared to the standard Khalkha hierarchy [coronal] > [low] > [labial] > [RTR].

(54) Contrastive hierarchy for Dagur

a. SDA: [coronal] > [labial] > [RTR]

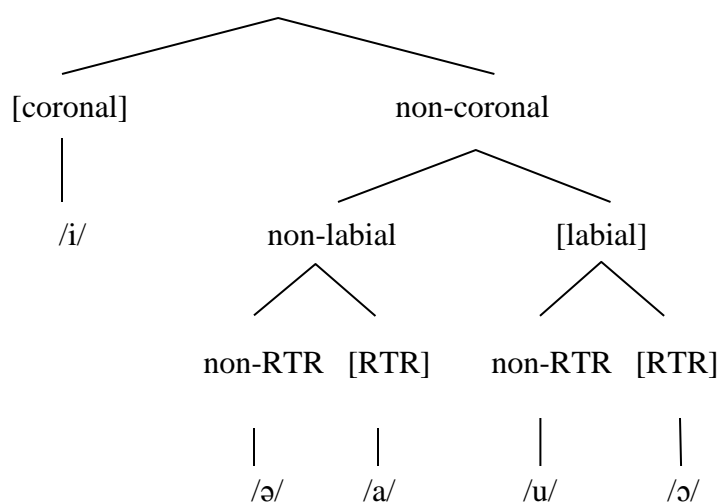

b. Output specifications

/i/ = [+cor]      /ə/ = [-cor, -lab, -RTR]      /u/ = [-cor, +lab, -RTR]  
/a/ = [-cor, -lab, +RTR]      /ɔ/ = [-cor, +lab, +RTR]

Note that there is no [low] feature in the proposed hierarchy. I assume that [low] was the lowest-ranked feature in the hierarchy at an earlier stage of Dagur (and other Dagur type languages) and is lost in modern Dagur. This analysis is supported by the synchronic analysis of Old Mongolian as having the contrastive hierarchy [coronal] > [labial] > [RTR] > [low] that will be presented in §0. Under this scenario, Dagur type languages directly inherited this Old Mongolian hierarchy, whereas Khalkha and

Monguor type languages (as well as Oirat type languages that we have not seen yet) have experienced the promotion of the feature [low] from the bottom to the second position in the hierarchy.

The evidence for the proposed features in the Dagur contrastive hierarchy comes from the relevant phonological patterns found in Dagur, which are summarized below.

(55) Evidence for the contrastive status of each feature in Dagur

Features	Phonological patterns
a. [coronal]	consonant palatalization and vowel umlaut
b. [RTR](or [low]) <sup>40</sup>	RTR (or “lowness”) harmony
c. [labial]	labial harmony; (less convincingly) labialized consonants historically conditioned by /u/ and /ɔ/

First of all, the contrastive status of [coronal] is evidenced by consonant palatalization. One notable feature of Dagur phonology is that it has the phonemic contrast between palatalized vs. plain consonants.

(56) Palatalized vs. non-palatalized Cs<sup>41</sup> (Chuluu, 1996, p. 5; Engkebatu, 1988, p. 131ff)

Palatalized		Non-palatalized	
tab <sup>i</sup>	‘fifty’	tab	‘pass through’
am <sup>i</sup>	‘life’	am	‘mouth’

---

<sup>40</sup> Although [RTR] and [low] are equally usable here, [RTR] is preferable to [low] in order to better understand the historical development of the Dagur vowel system. I discuss this in detail below.

<sup>41</sup> There seems to be dialectal differences with regard to the palatalization of consonants; e.g., the Qiqihar dialect has no palatalized consonants (Chuluu, 1996, p. 11; Engkebatu, 1988, p. 134).

mjaŋgə	‘thousand’	maŋgə	‘capable’
dʲald	‘late’	dald	‘thimble’
tʲak	‘tired’	tak	‘horseshoe’
tʲaɮ	‘herd’	tal	‘grassland’
alʲ	‘which’	al	‘kill’
gərʲ	‘house’	gər	‘torch’
kʲa:l	‘string bag’	ka:l	‘reason’
kʲər	‘honey’	kər	‘poison’
xʲat	‘break’	xat	‘tie, bind’

In many cases, the palatalized consonants in Dagur originate from the sequence of a consonant followed by high front vowel /i/ in Written Mongolian, e.g., Dagur *tabi* < Written Mongolian *tabi*, and Manchu, e.g., Dagur *gʲa:n* < Manchu *giyan* ‘principle’.

(57)	Dagur	W.Mong	Gloss	Dagur	W.Manchu	Gloss
	tabi	tabi	‘fifty’	nʲnamni-	niyamniya-	‘to shoot’
	mʲa <sup>w</sup>	miq-a	‘meat’	gʲa:n	giyan	‘principle’
	tʲoɮ	toli	‘mirror’	kokʲ	hoki	‘companion’
	sagʲi-	saqi	‘guard’	dalʲk <sup>w</sup>	dalikū	‘screen’
	xəkʲ	əkʲ	‘head’			

(Chuluu, 1996, p. 11)

Crucially, palatalization in Dagur is not just a historical trace, but an ongoing process. For example, word final /n/ is palatalized before the genitive suffix {-i:}.<sup>42</sup>

<sup>42</sup> Other descriptions also notes synchronic palatalization by /i/: for instance, Tsumagari (2003, p. 131)



(58) Palatalization as a synchronic rule (Chuluu, 1996, pp. 11&39)

Nom	Gen	Palatalization	Gloss
əulən	əulən-i:	[əulənʲ]	‘cloud’
gərən	gərən-i:	[gərənʲ]	‘everybody’
gurun	gurun-i:	[gurunʲ]	‘state’
ila:n	ila:n-i:	[ila:nʲ]	‘light’

Also, Seong (1999a) observes that /a/ tends to surface as [æ] mostly when the next syllable has [i], although this umlaut might not occur after velar stops in careful speech: e.g., /talibəi/ [talibe, tælibe] ‘to set; put’ (p. 619).

The contrastive status of [labial] is evidenced by labial harmony that is triggered only by the low rounded vowel /ɔ/.

(59) Labial harmony: triggered only by /ɔ/<sup>43</sup> (Chuluu, 1996, pp. 13, 31)

	Nominative	Instrumental	Ablative	Refl. Poss	Gloss
a.	ʃar	ʃar-a:r	ʃar-a:s	ʃar-a:	‘face’
	nər	nər-ə:r	nər-ə:s	nər-ə:	‘name’

---

states that /i/ “has a palatalizing effect on a preceding consonant, e.g., *nid* [nid] ‘eye.’ In addition, Yu et al. (2008, p. 20) reports that, in Tacheng dialect, “when [i] occurs in word-initial position, the palatal approximant [j] is added in front of [i], but only sporadically”: e.g., *iy eit* ~ *jiy eit* ‘a molar tooth.’ Also, there are cases where palatalized ([ç]) and non-palatalized ([x]) forms co-exist. These show the synchronic palatalizing effect of /i/, at least in a dialect of Dagur.

Tacheng	Qiqihaer	Buteha	Gloss
çila:z/xila:z	çila:z	xila:s	‘thread’

<sup>43</sup> Stems ending with a long vowel do not follow the labial harmony rule, but only “lowness” harmony rule, as illustrated below. /j/ is inserted between long vowels (Chuluu, 1996, pp. 13, 41).

Nominative	Instrumental	Ablative	Refl. Poss	Gloss
ʃɔlɔ:	ʃɔlɔ:-ja:r	ʃɔlɔ:-ja:s	ʃɔlɔ:-ja:	‘stone’
ado:	ado:-ja:r	ado:-ja:s	ado:-ja:	‘stocks’
pɔ:le:	pɔ:le:-ja:r	pɔ:le:-ja:s	pɔ:le:-ja:	‘ball’

xukur	xukur-ə:r	xukur-ə:s	xukur-ə:	‘cow’
b. mɔ:d	mɔ:d-ɔ:r	mɔ:d-ɔ:s	mɔ:d-ɔ:	‘tree’
kɔnfɔ:r	kɔnfɔ:r-ɔ:r	kɔnfɔ:r-ɔ:s	kɔnfɔ:r-ɔ:	‘mouth’
ɔr	ɔr-ɔ:r	ɔr-ɔ:s	ɔr-ɔ:	‘luggage’

It is tempting to say that contrastive [labial] specification is confined to low vowels based on this labial harmony fact. However, logically speaking, all we can say here is that /ɔ/ should have [labial] specification because it triggers labial harmony and that there may be a contrastive “height” distinction which distinguishes /ɔ/ from /u/. Basically, /u/ may or may not be specified for [+labial]. Even when /u/ is assigned the [+labial] specification, it does not mean that /u/ has to trigger labial harmony. In the phonology literature, labial harmony is known to be very sensitive to the height distinction and has been assumed to be a phenomenon that takes place to compensate for the perceptual difficulty of low back rounded vowels by prolonging the exposure duration of labiality (Kaun, 1995, 2004). In this sense, it could be some factor (“highness”) other than non-labiality that disqualifies /u/ from triggering labial harmony.

In fact, the phonemic contrast between labialized vs. plain consonants is indicative of the contrastive [+labial] specification for /u/. Here are examples showing the phonemic contrast:

- (60) Labialized vs. non-labialized consonants (Chuluu, 1996, p. 5ff.; Engkebatu, 1988, p. 136ff.)

Labialized		Non-labialized	
m <sup>w</sup> ə:r	‘shaft of a cart’	mə:r	‘eat’
d <sup>w</sup> ar	‘desire’	dar-	‘press’

t <sup>w</sup> a:l	‘to account’	ta:l	‘love’
s <sup>w</sup> ar	‘flea’	sar	‘moon’
k <sup>w</sup> a:	‘yard’	ka:	‘side of window’
x <sup>w</sup> al	‘bed’	xal	‘surname’
dʒ <sup>w</sup> a:r	‘mix’	dʒa:r	‘musk’
ʃ <sup>w</sup> a:k	‘green grass’	ʃa:k	‘the back of knee’

This contrast was historically conditioned by the following rounded vowels, both /u/ and /ɔ/, which indicates that these vowels were both specified for [labial] at an earlier stage.

(61) Labialization triggered by both high (/u/) and low (/ɔ/) rounded vowels (Chuluu, 1996, pp. 11–12; Engkebatu, 1988, pp. 29–32)

a. Low round trigger			b. High round trigger		
Dagur	W.Mong	Gloss	Dagur	W.Mong	Gloss
m <sup>w</sup> ə:r	möger	‘rim’	s <sup>w</sup> al	sula	‘loose’
t <sup>w</sup> a:l	toɣala-	‘to count’	k <sup>w</sup> al	qula	‘light black’
d <sup>w</sup> ar	door-a	‘below’	x <sup>w</sup> ar	qur-a	‘rain’
ʃ <sup>w</sup> ə:n	čögen	‘few’	g <sup>w</sup> rəb	ɣurban	‘three’

This strongly suggests that [labial] takes scope over [low] in this “earlier” Dagur: if [low] is the second highest feature in the hierarchy (following [coronal]), /u/ will receive specification for [-low] and will not receive further specification for [labial]. Then, it will be very difficult to explain the labializing effect of /u/.

According to Tsumagari (2003, p. 131), “both /u/ and (to a lesser extent) /ɔ/ [the symbol modified from /o/ by the author] have a labializing effect on a preceding

consonant,” although no examples are given. I was unable to find synchronic evidence for the contrastive [+labial] specification for /u/ in modern Dagur from available descriptions. However, based on Tsumagari’s description, I assume the [+labial] specification for /u/ in modern Dagur.

In addition to [coronal] and [labial], there should be a contrastive feature responsible for the “lowness” harmony pattern illustrated below. Both [RTR] and [low] seem to fit the requirement.

(62) “Lowness” harmony: /a/ vs. /ə, i, u/ (Chuluu, 1996, pp. 12ff & 40ff)<sup>44</sup>

	Nom	Allative	Instrumental	Gloss	
a.	xad	xad-da:	xad-a:r	‘cliff’	
	nas	nas-da:	nas-a:r	‘age’	
b.	gər	gər-də:	gər-ə:r	‘house’	
	nid	nid-də:	nid-ə:r	‘eye’	
	xukur	xukur-də:	xukur-ə:r	‘cow’	
	Verb	Abtemporal	Completive	Conditional	Gloss
c.	ta:l-	ta:l-rsa:r	ta:l-a:r	ta:l-a:s	‘like’
	gar-	gar-rsa:r	gar-a:r	gar-a:s	‘go out’
d.	əms	əms-rsə:r	əms-ə:r	əms-ə:s	‘wear’
	ir-	ir-rsə:r	ir-ə:r	ir-ə:s	‘come’
	xuns-	xuns-rsə:r	xuns-ə:r	xuns-ə:s	‘hungry’

Stems with a RTR (or low) vowel /a/ take suffixes with the RTR vowel /a/, whereas stems with non-RTR (or non-low) vowels /ə, i, u/ take suffixes with the non-RTR

<sup>44</sup> See Chuluu (1996, pp. 40–41) and Engkebatu (1988) for more examples.

vowel /e/. /i/ looks as if it were a non-RTR vowel. However, it is indeed neutral to the “lowness” harmony: it can co-occur either with a RTR (or low) stem or with a non-RTR (or non-low) stem. This indicates that the harmonic feature, [RTR] (or [low]), is not contrastive for /i/.

(63) /i/ is neutral to “lowness” harmony (Chuluu, 1996)

maŋgil-ʃa:r(\*-ʃə:r) ‘forehead-Terminative’ (p.18)

d<sup>w</sup>ariy-da:-ja:(\*-də:-jə:) ‘lower reaches of a river-Directive-Possessive’ (p.20)

Now let us consider the feature responsible for the “lowness” harmony. [RTR] and [low] seem to be interchangeable when it comes to the harmony pattern itself: both equally distinguish the harmonic sets, /a/ and /i, ə, u/. Both features can also distinguish the two rounded vowels /u/ and /ɔ/.

However, [RTR] seems to be the right choice here for two reasons. First, as Seong (1999a, p. 638) describes, /u/ and /o/ in this language are distinguished by the “tenseness of pharynx” as well as the size of the aperture. This auditory impression is hard to explain if we assume a simple height distinction. On the other hand, if we assume a tongue root contrast, then the auditory impression as well as the relative height difference can be accounted for.

Second, the merger pattern illustrated below indicates that the height distinction between /u, ʊ/ and /o, ɔ/ made by [ $\pm$ low] has been lost.

(64) Main reflexes of short Vs in initial syllables (cf. Svantesson et al., 2005)

Old Mong	*a	*ɔ	*ʊ	*ə	*o	*u	*i
Dagur	a	ɔ	ɔ, wa	ə	u	u	i

(65) Merger in Dagur:<sup>45</sup> \**i*, \**ö* > u and \**u*, \**o* > ɔ

a. u < \*<ü> (= [u])

Dagur	WM
xund ‘heavy’	xündü
uwei ‘no; not’	ügei
xujuu ‘neck’	xüjügüü

b. u < \*<ö> (= [o])

Dagur	WM
duc ‘forty’	döči/n
kurc ‘bowstring’	xöbči/n
kuly ‘foot, leg’	xöl

c. ɔ < \*<u> (= [ɔ])

Dagur	WM
gɔc ‘thirty’	yuči/n
ɔrj ‘nursing bottle’	uyji
ɔs ‘water’	usu/n

d. ɔ < \*<o> (= [ɔ])

Dagur	WM
mɔry ‘horse’	mori/n
xɔny ‘sheep’	χoni/n
tɔrs ‘button’	tobči

Note that the consequence of the merger is a more favored feature combination. /u/ and /ɔ/ with the sympathetic feature combination [αlow, αRTR] are favored over /ɔ/ and /o/ with the antagonistic combination [αlow, -αRTR] (Archangeli and Pulleyblank 1994).

In (66) below, I present an alternative contrastive hierarchy for Dagur. This time I use [low] instead of [RTR] to show that the choice between the two features has no crucial effect on the phonological patterning, although it might have some on the phonetic realization of each vowel.

(66) Contrastive hierarchy for Dagur (based on [low] instead of [RTR] for vowel harmony)

---

<sup>45</sup> The Dagur data here are from Tsumagari (2003) with his /o/ replaced with /ɔ/. See also Poppe (1955), Seong (1999a), and Svantesson et al. (2005).

a. SDA: [coronal] > [labial] > [low]

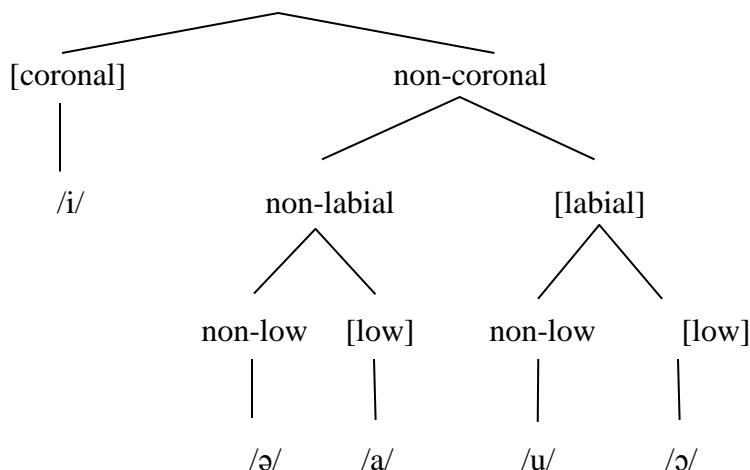

b. Output specifications

/i/ = [+cor]	/ə/ = [-cor, -lab, -low]	/u/ = [-cor, +lab, -low]
	/a/ = [-cor, -lab, +low]	/ɔ/ = [-cor, +lab, +low]

Historically speaking, [RTR] seems to be the right choice since [low] is what we lost through vowel mergers. However, at a later stage after the vowel mergers are completed, the distinction between the high and low vowel pairs (/ə/ and /a/, and /u/ and /ɔ/) can be equally nicely captured by [low] as well as [RTR]. Surely [low] is a synchronically viable option for language learners at this stage. Or it may be better option, if [low] can be said to be less marked than [RTR]. The resulting contrastive hierarchy is very similar to that of Monguor type languages we have seen in §0 in spite of the different paths the two types of languages have taken.

### 2.2.3.2. Buriat

Buriat has a 7 vowel system, which is close inventory-wise to the Khalkha vowel system.

(67) Buriat vowel system (Poppe, 1960b; Skribnik, 2003, p. 104)<sup>46</sup>

i	u
	ʊ
ə <sup>47</sup>	(o)
a	ɔ

The vowel /o/ is given in parentheses, since short /o/ does not occur in non-initial syllables (Poppe, 1960b, p. 7). This is because the short vowel /o/ has merged with /u/, whereas the long vowels /u:/ and /o:/ are preserved distinct (Skribnik, 2003, p. 105).

The merger /o, u/ > /u/ has been considered “to constitute one of the distinctive characteristics of Buriat” (Skribnik, 2003, p. 105). However, its significance has been exaggerated in the literature, since we have already seen that this type of merger (merger by height neutralization) had much wider effect in other Mongolic language, Dagur. As we will see shortly, Khamnigan Mongol also shows the same merger pattern: Khamnigan lost the contrast between /u/ and /o/, whether short or long.

Within the Buriat language, there is a contrast between Western Buriat and Eastern Buriat in this regard: unlike Eastern Buriat where /u, o/ have merged to /u/, Western Buriat retains the contrast between short /u/ and /o/ in initial syllables (Svantesson et

---

<sup>46</sup> This vowel system is confirmed by recent acoustic studies by Bayarmend (2006) and Kang and Ko (2012).

<sup>47</sup> This vowel has been normally rendered as /e/ in the literature, although it has also been noted that it is pronounced as a “central” vowel (Poppe, 1960b, p. 6). Therefore, I will use /ə/ and, accordingly, present data from other sources with necessary modifications.



al., 2005, p. 145). Thus, it seems that there is a continuum from Western Buriat on one extreme to Dagur on the other extreme along which we can locate Eastern Buriat and Khamnigan Mongol.

I propose the following contrastive hierarchy for Buriat.

(68) Contrastive hierarchy for Buriat

a. SDA: [coronal] > [labial] > [RTR] > [low]

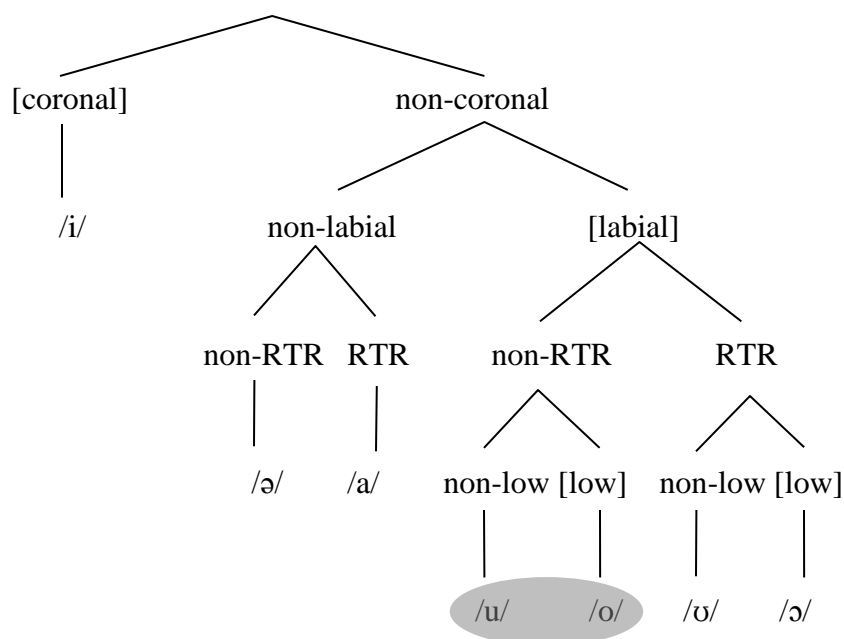

b. Output specifications

/i/ = [+cor]

/u/ = [-cor, +lab, -RTR, -low]

/ʊ/ = [-cor, +lab, +RTR, -low]

/ə/ = [-cor, -lab, -RTR]

/o/ = [-cor, +lab, -RTR, +low]

/a/ = [-cor, -lab, +RTR]

/ɔ/ = [-cor, +lab, +RTR, +low]

Basically Buriat shows very similar phonological patterns with Mongolian Proper such as Khalkha. /i/ triggers consonant palatalization (Poppe, 1960b, pp. 8–9), resulting in the opposition between plain vs. palatalized segments (Skribnik, 2003, pp.

105–6). Buriat has both RTR harmony (contra Poppe’s palatal harmony analysis) and labial harmony. The transparency and opacity of vowels to harmony processes is also similar: /u, ʊ/ do not trigger but block labial harmony; /i/ is transparent to labial harmony.

- (69) Evidence for the activeness of the features [coronal], [labial], [RTR], [low]
- a. [coronal]: consonant palatalization
  - b. [RTR]: RTR harmony
  - c. [labial]: labial harmony
  - d. [low]: only low rounded vowels trigger labial harmony, while high rounded vowels block labial harmony (but cf. [u] – see (77) below)

The contrastive status of [coronal] is evidenced by the palatalizing effect of /i/.

- (70) /i/ triggers consonant palatalization (Skribnik, 2003, pp. 105–6)

mʲaxa/n < *mika/n	‘meat’
ərʲə:n < *eriyen	‘motley’
tulxʲu:r < *tülkixür	‘key’

Although the opposition between plain vs. palatalized segments shown above is historical and thus mostly phonemic, “in some cases the palatalization is not phonemic”: a consonant followed by /i/ is always palatalized and “there is therefore no opposition of palatalized to unpalatalized consonants before /i/” (Poppe, 1960b, pp. 9, 20, 30).

The contrastive status of [RTR] is evidenced by RTR harmony, although it has long been analyzed as a palatal type harmony (e.g., Poppe, 1960b).

(71) RTR vowel harmony (Kaun, 1995; Poppe, 1960b)

a. non-RTR stems

xəl-u:l ‘speak-CAU’

əxə-də: ‘mother-DAT.REFL’

xul-də ‘foot-DAT’

du:-gə:r ‘younger brother-INST’

b. RTR stems

al-ɔ:l ‘kill-CAU’

axa-da: ‘elder brother-DAT.REFL’

xoŋ-da ‘swan-DAT’

bəlag-a:r ‘well-INST’

Stems containing only /i/ act as if they were a non-RTR stem, taking a non-RTR suffix.

(72) Monosyllabic stems with /i/ act like non-RTR words (drawn from Poppe, 1960b)

xi:-də ‘dung dust-DAT’

ti:g-ə:d ‘to do that way-GERUND’

However, /i/ is indeed neutral to RTR harmony, which indicates that it is neither non-RTR nor [RTR].

(73) /i/ in RTR words: /i/ is neutral to RTR vowel harmony (Kaun, 1995; Poppe, 1960b)

ilangaja: ‘particularly’

mal-i:ji ‘cattle-DIR.OBJ’

ax-i:n-da ‘at the elder brother’s’

imagta ‘exclusively’

bəlag-i:ji ‘the well-DIR.OBJ’

The contrastive status of [labial] is evidenced by labial harmony. The labial harmony pattern in Buriat is basically the same as in Mongolian Proper in that the harmony is triggered only by low rounded vowels.

(74) Labial harmony (Kaun, 1995, p. 61; Poppe, 1960b)

a. low rounded Vs: trigger	b. high rounded Vs: non-trigger
mɔd-ɔ:r ‘tree-INST’	ʃubʊ:-ga:r(*-gɔ:r) ‘bird-INST’
ɔʃ-ɔ:d ‘to go away-GERUND’	ʊ:g-a:d(*-ɔ:d) ‘to drink-GERUND’
mɔdɔn-dɔ: ‘tree-DAT.REFL’	xʊng-da:(*dɔ:) ‘swan-DAT.REFL’
o:r-do: ‘self-DAT.REFL’	xuzu:n-də:(*-do:) ‘neck-DAT.REFL’
to:n-do: ‘white spot-DAT.REFL’	xuj-də:(*-do:) ‘umbilicus-DAT.REFL’

The high rounded vowels /u, ʊ/ block the harmony.

(75) High rounded vowels block labial harmony (Kaun, 1995; Poppe, 1960b)

xo:r-u:l-ə:	*xo:r-u:l-o:	‘he made (someone) chat’
zɔrjʊl-xa	*zɔrjʊl-xɔ	‘to direct toward’
dɔrjʊxana:r	*dɔrjʊxɔnɔ:r	‘rather firmly’
zɔrigdʒʊ:l-xa	*zɔrigdʒʊ:l-xɔ	‘to inspire, to induce, to stimulate’
ɔr-ʊ:l-xa	*ɔr-ʊ:l-xɔ	‘to enter (CAU)’

Unlike /u, ʊ/, /i/ is transparent to labial harmony.<sup>48</sup>

---

<sup>48</sup> Poppe (1960b, p. 23) regards short /ə/ as transparent to labial harmony as well: e.g., *xo:rəldo*: ‘they conversed, talked to each other, chatted’ (see also Kaun, 1995, p. 61). However, [ə] in this non-initial position may be a reduced realization of /o/, which can be easily misheard to foreigners’ ears. Cf. Khalkha *xəpərdəx* ‘to converse; to talk.’ (See also Svantesson et al. 2005, Chapter 6 “Syllabification and epenthesis.”)

(76) /i/ is transparent to labial harmony (Kaun, 1995, pp. 61–2; Poppe, 1960b)

mərin-d-ɔ:	‘horse-DAT.REFL’	mərin-hɔ:	‘horse-ABL’
bəli-xɔ:	‘to discontinue’	dɔxi-xɔ:	‘to nod, to bow’
sɔxi-sɔ:	‘rhythmical beating’	zo:ri-do:	‘possessions-DAT.REFL’

The merger /o, u/ > /u/ adds a complication to the harmony pattern: the high rounded short vowel /u/ in initial syllables can sometimes trigger labial harmony, targeting non-high long vowels (Kaun, 1995, p. 63)

(77) Cases where high short /u/ triggers labial harmony<sup>49</sup> (Poppe, 1960b, p. 23) (cf. Kaun, 1995, p. 63)

Buriat		cf. Written Mong.	Khalkha <sup>50</sup>
xul-do:	‘foot-DAT.REFL’	xöl	xol хөл
ug-o:	‘he gave’	ögxü	ogox өгөх
tur-o:	‘he was born’	töröxü	torox төрөх
gurəl-o:	‘braid-REFL’	gürümel	gormol гөрмөл
bud-o:r	‘cotton textile-INST’	bös	bos бөс
udər-o:r	‘day- INST’	edür	odor өдөр
dur-o:	‘it burned’	tülexü	tulex түлэх
xur-o:	‘he arrived’	xürxü	xulex хүрэх
uz(ə)-o:	‘he saw’	üjexü	uzex үзэх

<sup>49</sup> In Kaun (1995, p. 84), it is stated that /u/ and /ʊ/ function as triggers in Buriat labial harmony, but no examples are provided for cases involving /ʊ/.

<sup>50</sup> These Written Mongolian and Khalkha cognates are provided by the author. Some of them are the author’s best guess.

ux(ə)-o:	‘he died’	üxüxü	uxex	ҮХЭХ
sub-o:	‘residue-refl’	sübe	suv	СҮВ

However, this might not pose a serious problem under the proposed contrastive hierarchy analysis in (68) where all phonetically rounded vowels receive a contrastive [+labial] specification.

The phonological observations made so far indicate that Buriat vowel system is minimally different from that of Mongolian Proper. This minimal difference is captured in terms of the difference in the contrastive hierarchy, namely the difference in the ranking of [low].

### 2.2.3.3. Khamnigan Mongol

The Khamnigan are bilingual in Evenki (a Tungusic) and Khamnigan Mongol (a Mongolic). The interactions between these two languages seem to have strengthened the “inherent phonological and morphological parallelism.” Nevertheless, the more dominant language is Khamnigan Mongol. It seems to be assumed that Khamnigan Ewenki has assimilated to Khamnigan Mongol, not vice versa (Janhunen, 2003c, 2005). Thus, I assume that the phonological patterns discussed here are of Mongolic origin, not of Tungusic. Indeed, Khamnigan is considered to be the most conservative Mongolic language (Janhunen, 2003c, 2005).

Khamnigan Mongol has six simple vowel phonemes.<sup>51</sup>

---

<sup>51</sup> No consensus on the Khamnigan vowel inventory has been reached yet. For example, Damdinov (1968, pp. 79–80, as cited in Janhunen 2005) assumes a seven vowel system containing an extra rounded vowel /o/, whereas Janhunen (2005, p. 22) a five vowel system (/i, e, a, o, u/). However, the description in Janhunen (2005, p. 22) implies that Khamnigan has a very similar vowel system to Buriat. First of all, the “normal” pronunciation of /o/ is [ɔ], which is distinguishable from a labialized allophone of /e/ (presumably [o]). This reminds us of the loss of short /o/ in Buriat. Second, there seems to be a distinction between a high and a mid-high rounded vowel, whether phonetic ([u, ʊ]) or phonological (/u,

- (78) Khamnigan phonemes (Svantesson et al., 2005, p. 147), drawing on Janhunen (2003c, pp. 86–7)

i      u  
           ʊ  
           ə<sup>52</sup>  
 a    ɔ

This six vowel system is the result of the vowel merger between /u/ and /o/, which has also taken place in Dagur and Buriat.

- (79) Main reflexes of short Vs in initial syllables (adapted from Svantesson et al., 2005, p. 180)

Old Mong	*a	*ɔ	*ʊ	*ə	*o	*u	*i
Khamnigan	a	ɔ	ʊ	ə	u	u	i

The contrastive hierarchy I propose for Khamnigan Mongol is the same as the hierarchy for Buriat (68), except for the completion of the merger between /o/ and /u/ in Khamnigan.

---

ʊ/). Janhunen (2005), unlike Janhunen (2003c), ascribes this assumed-to-be distinction to “the influence of Mongolian Proper in the speech of bilingual individuals” (Janhunen, 2005, p. 22). Based on the near minimal pair like *ɖʒon* ‘summer’ vs. *ɖʒug* ‘direction’ (Janhunen, 2003c, p. 87), I assume they are distinct phonemes.

<sup>52</sup> Although there is no phonetic description on the quality of the vowel rendered /e/ in previous literature, I assume /ə/ instead of /e/, considering the Buriat and Dagur equivalents.

(80) Contrastive hierarchy for Khamnigan Mongol

a. SDA: [coronal] > [labial] > [RTR] > [low]

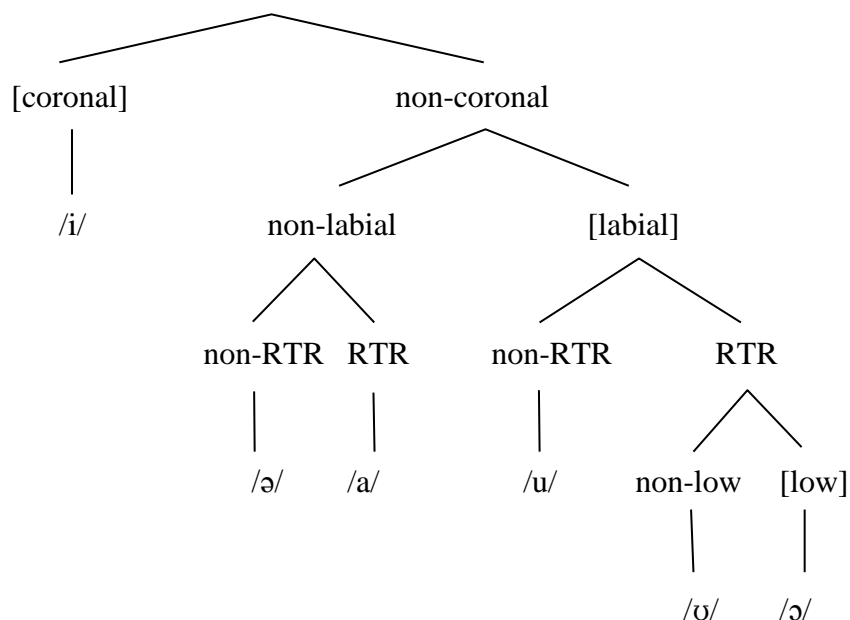

b. Output specifications

/i/ = [+cor]

/u/ = [-cor, +lab, -RTR]

/ʊ/ = [-cor, +lab, +RTR, -low]

/ə/ = [-cor, -lab, -RTR]

/a/ = [-cor, -lab, +RTR]

/ɔ/ = [-cor, +lab, +RTR, +low]

Published descriptions on Khamnigan vowel patterns are very rare. I could only found the following example as possible evidence for synchronic palatalizaion, although I am unaware of how productive it is.

(81) Khamnigan palatalization (Yu, 2011, p. 19)

emčilək [emt<sup>h</sup>ilək<sup>h</sup>] ~ emtilək [em<sup>t</sup>h<sup>h</sup>ilək<sup>h</sup>] ‘to treat, to doctor’

cf. Kh. эмчлэх; Бу. эмшэлхэ; WM emčilekü



Also, Svantesson et al. (2005, pp. 200-201) note that the reflexes of OM \*č and \*č<sup>h</sup> in Khamnigan are [č] and [č<sup>h</sup>] before /i/ (< \*i), and [c] and [c<sup>h</sup>] elsewhere: they analyze this distribution as “phonemes /c/ and /c<sup>h</sup>/, with the palatalized allophones [č] and [č<sup>h</sup>] before /i/.”

Khamnigan also has RTR harmony as well as labial harmony (Svantesson et al., 2005, p. 147). The labial harmony seems to be triggered only by /ɔ/<sup>53</sup> (Janhunen, 2003c, p. 88).

(82) Khamnigan vowel harmony (adapted from Janhunen, 2005, p. 25)<sup>54</sup>

- a. udʒə-nən ‘to see-Durative’
- b. kara-nan ‘to watch-Durative’
- c. ɔɔ-nən ‘to enter-Durative’

The vowel /i/ is neutral in the sense that it can co-occur with any other vowels.

---

<sup>53</sup> Interestingly, long [ɔ:] does not trigger labial harmony: e.g., *galɔ:* ‘goose’, *bɔ:dal* ‘hotel’, *nɔ:r-a:ha* ‘lake-Abl.’ presumably “due to diachronic phenomena” (Janhunen, 2005, pp. 24–25). Andrew Joseph (p.c.) noticed that these words never contained the original /ɔ/ and suggested that it is possible to analyze Khamnigan [ɔ:] as /aʊ/. (Cf. Uilta [o:] and [ɔ:] derived from /du + ba/ in §4.2.2.4.)

Khamnigan	Khalkha	W.Mong	Gloss	Data from Andrew Joseph (p.c.)
[galɔ:]	[galɔ:]	yalayu	‘goose’	
[bɔ:dal]	[bɔ:dal]	bayudal	‘hotel’	
[nɔ:r]	[nɔ:r]	nayur	‘lake’	

There might also have been some influence of Khamnigan Ewenki, as in some Tungusic languages a long rounded vowel does not spread its [+labial] feature, e.g., Oroqen (X. Zhang, 1996, pp. 189–190).

<sup>54</sup> I assume RTR harmony for Khamnigan Mongol, contra Janhunen (2005) who claims palatal harmony based on the assumed-to-be five vowel system. Janhunen (2003c, p. 22) divides the five vowels into three sub-groups: “front” vowel /e/, “back” vowels /a, o/, and “neutral” vowels /i, u/. The neutrality of /u/ is the consequence of disregarding the distinction between a high and a mid-high rounded vowels /u, ʊ/.

(83) /i/ is neutral (Janhunen, 2005, p. 22)

a. RTR stems		b. non-RTR stems	
mika/n	‘meat’	sinə	‘new’
mōri/n	‘horse’	huri	‘every’

I have found no examples in the literature revealing the transparency/opacity of /i/ and /u, ʊ/ with respect to labial harmony. However, I assume that /i/ is transparent but /u, ʊ/ are opaque to labial harmony based on the statement by Janhunen (2005, p. 23) that /i/ “can both follow and be followed by any other vowel” whereas /u/ “can follow any other vowel, but can only be followed by the vowels /a, e, u, i/ (but not /o/).”

#### 2.2.3.4. A note on Type III (Dagur type) languages

We have seen that Dagur, Buriat, and Khamnigan Mongol have experienced a similar change (vowel merger) to varying degrees. This can be summarized as follows:

(84) Vowel merger pattern in Dagur type languages

<b>W. Buriat</b>	→	<b>E. Buriat</b>	→	<b>Khamnigan</b>	→	<b>Dagur</b>
i		u		i		u
		ʊ				ʊ
ə		o		ə		ə
a		ɔ		a		ɔ
<hr/>						
loss of short /o/		loss of short /o/		loss of /o/		loss of /ʊ, o/
in non-initial σ						

This change can be characterized as merger by height neutralization, which is presumably conditioned by the lowest-ranked [low] feature.

This type of merger also can receive a phonetically grounded explanation. We know that tongue root retraction may be associated with tongue body movement downward and backward. The acoustic correlation of this is that the contrast between the back rounded harmonic pairs (/u/ and /ʊ/, and /o/ and /ɔ/) can be realized as an F1 and, less reliably, an F2 difference.

Archangeli & Pulleyblank (1994) illustrates the implicational relations between tongue height and tongue root features as follows. (Note here that they do not distinguish [ATR] and [RTR] as two distinct features but treat them as interchangeable with reverse polarity, i.e., [ $\alpha$ ATR] = [ $-\alpha$ RTR].)

(85) Implicational relations between height and tongue root features (Archangeli and Pulleyblank 1994)

- a. [+high] implies [+ATR], not [-ATR]      b. [+low] implies [-ATR], not [+ATR]

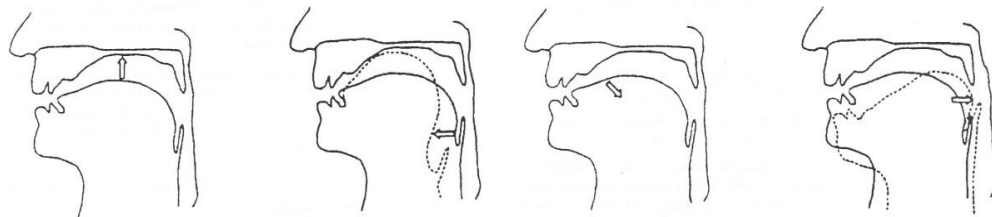

- c. [+ATR] implies [+high] not [-high]      d. [-ATR] implies [-high], not [+high]  
 [+ATR] implies [-low] not [+low]      [-ATR] implies [+low], not [-low]

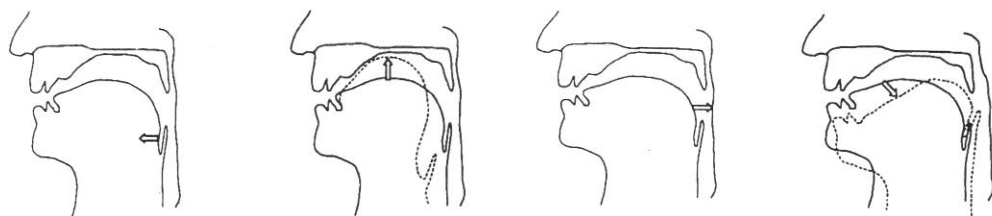

It is widely documented that tongue body raising/lowering and tongue root advancement/retraction have similar acoustic effects: lowering of the first formant F1 by tongue body raising and tongue root advanced versus raising of F1 by tongue body

lowering and tongue root retraction (Fulop et al., 1998; Guion et al., 2004; Halle & Stevens, 1969; Ladefoged, 1964; Ladefoged & Maddieson, 1996; Lindau, 1974, 1975, 1978, 1979; Pike, 1947). Therefore, certain feature combinations (e.g., [+high] and [+ATR]) are “sympathetic” in the sense that the two features share the same phonetic effect, whereas others (e.g., [+high] and [-ATR]) are “antagonistic” in the sense that their phonetic effects conflict with each other.

When a tongue root feature interacts with a tongue body feature, one feature specification can be either sympathetic or antagonistic to the other: e.g., [+low, +RTR] is a sympathetic combination whereas [-low, +RTR] is an antagonistic one (Archangeli & Pulleyblank, 1994). The acoustic effect of the feature combination involving a height and a tongue root feature ([high] and [ATR] here) can be represented as follows:

(86) The acoustic realization of [ATR] (Archangeli & Pulleyblank, 1994, p. 249)

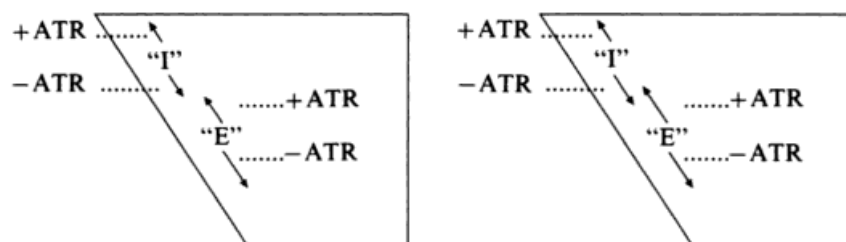

The symbols “I” and “E” stand for the position of a canonical high and mid vowel, respectively, representing the effect of the [ $\pm$ high] component of a vowel. The arrows represent the additional effect of [ $\pm$ ATR] component. The magnitude of the effect of the tongue root movement seems to vary depending on language (Archangeli & Pulleyblank, 1994, p. 249; Casali, 2008, p. 508). When the effect is relatively small, as in the diagram on the left in (86), there is no overlap or reversed height relation between the high [-ATR] vowel /i/ and the mid [+ATR] vowel /e/, resulting in a “canonical” vowel system found in languages like DhoLuo and Epira. In contrast,

when the effect of [±ATR] is relatively large, as in the diagram on the right in (86), a “phonetic overlap” between /ɪ/ and /e/ may result, as attested in Akan (Lindau, 1979), Ijò (Ladefoged & Maddieson, 1990), and arguably Okpe and Chukchi (Archangeli & Pulleyblank, 1994, p. 249).<sup>55</sup> This idea presented by Archangeli and Pulleyblank can be applied to Dagur type languages (Dagur, Buriat, and Khamnigan), where the features [±low] and [±RTR] (and also possibly [±coronal] and [±RTR]) interact for back rounded vowels /u, ʊ, o, ɔ/. If the effect of [±RTR] is relatively large in Dagur type languages, the low non-RTR vowel /o/ may be realized “higher” and “fronter” than the high RTR vowel /ʊ/. The result is an overlap between (or a closer realization of) /u/ and /o/, which develops into a merger. In terms of contrastive hierarchy, the large effect of [±RTR] may be interpreted as the manifestation of relatively higher ranking of the [RTR] feature in these languages.

Interestingly enough, the geographical distribution of these languages coincides with the direction of this change. If we look at the map of the modern Mongolic languages (Svantesson et al., 2005, p. 141) in Figure 4, we notice that W. Buriat, E. Buriat, Khamnigan Mongol, and Dagur are spoken in areas adjacent to one another in the given order. Note that Svantesson et al. (2005, p. 190) classifies Khamnigan into “Mongolian type,” not “Dagur type” with respect to the proposed Mongolic vowel harmony shift.

It is notable that there may be a correlation between the merger by height neutralization and the writing system. It is well known that Written Mongolian scripts use the same symbol for /u/ and /o/, and for /ʊ/ and /ɔ/, respectively. Dagur type languages, which show the merger between /u/ and /o/ and between /ʊ/ and /ɔ/, to

---

<sup>55</sup> Archangeli and Pulleyblank (1994, p. 249) claims that the “apparent neutralization” cases in Okpe and Chukchi should be viewed not as the result of phonological neutralization but as the result of phonetic overlap effect.

varying degrees, have been written in Written Mongolian. On the other hand, Monguor type languages, which show the merger by RTR neutralization (the merger between /u/ and /ʊ/ and between /o/ and /ɔ/) have never had any writing system at all.

Before the introduction of modern writing systems, the Eastern Buriat traditionally used Classical Written Mongolian (Skribnik, 2003, pp. 103–4), although the Western Buriat has used the Cyrillic alphabet since about 1840 (Svantesson et al., 2005, p. 145). The Dagur are known to normally use Mongolian (or Chinese) as their written language (Svantesson et al., 2005, p. 150). The Khamnigan Mongol also use (Modern) Written Mongolian, although literacy in Written Mongolian among the Khamnigan is a recent phenomenon (Janhunen, 2005, p. 20).

By contrast, it does not seem that the Gansu-Qinghai Mongolic languages have a regularly used writing system (Svantesson et al., 2005, p. 151). Most of them have not been written at all, although a Latin-based writing system was devised for a variety of Monguor (Huzhu dialect) and Santa (Dongxiang) around 1980. Shira Yugur speakers use Chinese as their written language.

#### 2.2.4. *Type IV: Oirat type languages*

The fourth type is Oirat type languages, which include Oirat and Kalmyk. The ethnonym Oirat is used to refer to several groups of Western Mongols who once established the so-called Junghar Khanate (Jungharia or Dzungaria). In the present day, the Oirats live scattered across the far west of the Mongolia, the northwest of China, and the northwest of the Caspian Sea. The Kalmyks are descendants of Oirat groups who migrated to the west and settled along the Lower Volga and the Caspian Sea in 17th century. The Kalmyk language is regarded as a distinct language by some researchers, but it is basically the same as the Oirat language spoken in the east.<sup>56</sup>

Oirat comprises a number of dialects, traditionally identified on a tribal basis, and shows only small differences. The main dialects in Mongolia are Dörbet, Bayat, Torgut, Uriankhai, Ö öld, Zakhchin, and Khoton. In China, Torgut and Hoshuud are spoken in Xinjiang and Qinghai, respectively. There are two main dialects in Kalmyk: Dörbet and Torgut.

Some other varieties are difficult to classify, because they show some Mongolian and some Oirat features at the same time. For example, the Alshaa dialect spoken in Alshaa league in South Mongolia is closer to Oirat with respect to its phonology (Svantesson et al., 2005, p. 148) but closer to Mongolian with respect to its morphology (Sečenbayatur, Qasgerel, Tuyay-a, ĵirannige, & U Ying ĵe, 2005, pp. 190–1). Some Oirat dialects in China (Heilongjiang province) and in Mongolia are said to be changing rapidly under the influence of Mongolian Proper (Svantesson et al., 2005, p. 148 and references therein).

It has been assumed that Oirat retains the Old Mongolian vowel system which is based on the front-back contrast. It is true that Oirat has a palatal system, but in §0, I

---

<sup>56</sup> See Birtalan (2003) and Svantesson et al. (2005) for further details.

will revisit and argue against the assumption that Old Mongolian also had a vowel system of palatal type.

#### 2.2.4.1. Kalmyk and Oirat

The typical Kalmyk/Oirat vowel system is shown below:

- (87) Kalmyk/Oirat vowel system (Birtalan, 2003; Bläsing, 2003; Svantesson, 1985, p. 303; Svantesson et al., 2005, p. 149)

i	y	u
e	ø	o
ɛ	a	

The vowel /ɛ/ has a secondary origin: it is mainly the product of vowel umlaut, i.e., /a/ conditioned by /i/ (Birtalan, 2003, p. 212; Svantesson et al., 2005, pp. 158–177).

- (88) The vowel /ɛ/ in Kalmyk (data drawn from Svantesson et al., 2005, pp. 158–177)

	Old Mong <sup>57</sup>	Kalmyk	gloss
a.	*k <sup>h</sup> ari-	xɛr-	‘to return’
	*naiman	nɛ:mn	‘eight’
	*narin	nɛrn	‘fine’
	*pari-	bɛr-	‘to hold’
	*sain	sɛn	‘good’

---

<sup>57</sup> The OM forms presented in this subsection are mostly from Svantesson et al. (2005) (unless otherwise noted), and thus based on the conventional “palatal” analysis of the OM vowel system.



	*sak <sup>h</sup> i-	sɛk <sup>h</sup> -	‘to protect’
	*t <sup>h</sup> ak <sup>h</sup> i-	t <sup>h</sup> ɛk <sup>h</sup> -	‘to offer’
	*t <sup>h</sup> apin	t <sup>h</sup> ɛwn	‘fifty’
b.	*nek <sup>h</sup> ei	nek <sup>h</sup> ɛ	‘sheepskin’
	*emehel	emɛl	‘saddle’
	*sirihe	ʃirɛ	‘table’
	*t <sup>h</sup> emehen	t <sup>h</sup> emɛn	‘camel’

If we exclude /ɛ/ from the inventory, the remaining vowel system is essentially the same as that of Written Oirat.<sup>58</sup>

(89) Written Oirat vowel system (Rákos, 2002, p. 8)

i	y	u
e	ø	o
	a	

The vowels /y, ø, u, o/ in Kalmyk/Oirat correspond to /u, o, ʊ, ɔ/ in Khalkha respectively.

---

<sup>58</sup> Written Oirat is a literary language of Oirats written in the Clear Script. The Clear Script was created in 1648 by the Oirat Buddhist monk Zaya Pandita based on the Uigur-Mongolian script. Although Written Oirat was strongly influenced by Written Mongolian, it was “closer to the contemporary spoken language in many aspects than Written Mongolian”, especially in the aspect of the vocalic system (Rákos, 2002, p. 6). The Clear script and Written Oirat spread throughout the whole Oirats including Kalmyk (Rákos, 2002, p. 6). Thus, I assume that the modern languages (Spoken Oirat and Kalmyk) and Written Oirat share the same contrastive hierarchy. For this reason (and also due to lack of sufficient data in the literature), I treat the phonological patterns in Written Oirat, Spoken Oirat, and Kalmyk reported in the literature equally as evidence for the contrastiveness of relevant features in Type IV languages. However, ideally in future researches, Written Oirat should be treated separately from modern Spoken Oirat including Kalmyk. See Rákos (2002) and Kara (2005) for further details on the Written Oirat language and the Clear Script, respectively.

(90) Vowel correspondence between Kalmyk/Oirat and Khalkha (/ɛ/ excluded)

Kalmyk/Oirat	/i/	/e/	/a/	/y/	/u/	/ø/	/o/
Khalkha	/i/	/e/	/a/	/u/	/ɔ/	/o/	/ɔ/

Notably, Kalmyk/Oirat vowels show contrast between front and back vowels: /e, y, ø/ vs. /a, u, o/. This front-back contrast is confirmed by the acoustic data of Kalmyk in Svantesson (1995).

The contrastive hierarchy I propose for Kalmyk/Oirat is as follows:

(91) Contrastive hierarchy for Kalmyk/Oirat

a. SDA: [coronal] > [low] > [labial] > [dorsal]

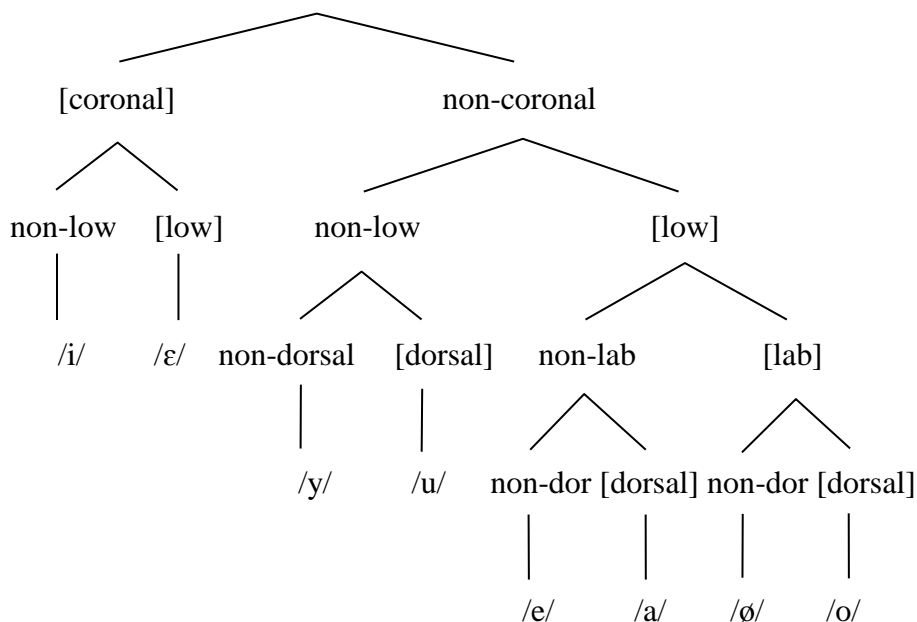

b. Output specifications

/i/ = [+cor, -low]    /y/ = [-cor, -low, -dor]    /u/ = [-cor, -low, +dor]  
 /ɛ/ = [+cor, +low]    /e/ = [-cor, +low, -lab, -dor]    /a/ = [-cor, +low, -lab, +dor]  
 /ø/ = [-cor, +low, +lab, -dor]    /o/ = [-cor, +low, +lab, +dor]

This hierarchy is very similar to the Khalkha hierarchy. The major difference is, however, the replacement of [RTR] in Khalkha with [dorsal] in Kalmyk/Oirat. This difference will be discussed shortly.

The evidence for the activeness (and thus the contrastiveness) of the features [coronal], [low], [labial], and [dorsal] is found in the phonological patterns of the Kalmyk/Oirat vowels (Birtalan, 2003; Bläsing, 2003) as summarized below:

- (92) Evidence for the activeness of the features [coronal], [low], [labial], [dorsal]
- a. [coronal]: vowel umlaut (and consonant palatalization) triggered by /i/
  - b. [low]: only low rounded vowels trigger labial harmony (Written Oirat)
  - c. [labial]: labial harmony (Written Oirat)
  - d. [dorsal]: “palatal” harmony

I present the evidence for these features in reverse order. First, the evidence for the contrastive status of [dorsal] is palatal harmony.

(93) Palatal harmony

- a. Kalmyk palatal harmony (data drawn from Bläsing, 2003)

Front stems		Back stems	
ger-εs	‘house-ABL’	ang/g-as	‘game-ABL’
ger-yr	‘house-DIR’	ang/g-us	‘game-DIR’
ykr-εs	‘cow-ABL’	u:l-as	‘mountain-ABL’
ykr-yr	‘cor-DIR’	u:l-ur	‘mountain-DIR’
møsn-εr	‘ice-INST’	ghos-ar	‘boots-INST’

b. Written Oirat (data drawn from Rákos, 2002)

teŋgeri-ner	‘god-PL’	albatu-nar	‘vassal-PL’ (p.15)
ger-my:d <sup>59</sup>	‘house-PL’	gal-mu:d	‘fire-PL’ (p.16)
meke-dy	‘trickery-DAT/LOC’	xa:n-du	‘king-DAT/LOC’ (p.20)

Second, the features [labial] and [low] are evidenced by the labial harmony pattern found in Written Oirat. For instance, the general past tense marker has four allomorphs in Written Oirat *-baj/bej/boj/bøj* (94)a that alternate according to labial harmony (as well as palatal harmony), e.g., *jabu-baj* ‘go-Past’, *kyr-bej* ‘reach-Past’, *bol-boj* ‘become-Past’ (Rákos, 2002, p. 33). There is also stem-internal labial attraction as in (94)b.

(94) Written Oirat labial harmony (Rákos, 2002, pp. 12–3)

a. Suffixal labial harmony

Written Mong	Written Oirat	Gloss
-γsan/qsen	-qsan/qsen/qson/qsøn	Nomen perfecti (past tense verbal noun)
-baj/bej	-baj/bej/boj/bøj	Praeteritum perfecti (general past tense)

b. Labial attraction in stems

Written Mong	Written Oirat	Gloss
morda-	mordo-	‘to depart’
dörben	dørbøn	‘four’

<sup>59</sup> The suffix *-mü:d/mu:d* is a colloquial form borrowed in Written Oirat (Rákos, 2002, p. 16).

Most Spoken Oirat dialects and Kalmyk, unlike Written Oirat, do not seem to have regular labial harmony: e.g., \**jiluxa* [WM: *jīloyo*] ‘rein/s’ > WO *joloo* > SO *jola* (Birtalan, 2003, p. 213). However, Alshaa and Hoshuud dialects have labial harmony: e.g., Alshaa/Hoshuud *gørøʂ* vs. Kalmyk/Xinjiang Oirat *gørɛsn* ‘beast’ < OM \**kørehesyn* (Svantesson et al., 2005, p. 149).

Finally, the evidence for [coronal] comes from the vowel umlaut facts.

(95) Vowel umlaut in Oirat (Birtalan, 2003, p. 212; see also Bläsing, 2003, p. 230ff for Kalmyk)

Old Mong	Spoken Oirat	Gloss	
*kari	xɛr	‘alien’	(WM <i>χari</i> ‘foreign; alien’)
*kubi	xyw~xøw	‘share’	(WM <i>χubiyari</i> ‘distribution; quota’)
*mori/n	mør/n	‘horse’	

Note that vowel umlaut is not confined to \*a, but is also applied to other original back vowels \*u and \*o. However, according to Svantesson et al. (p. 211), these secondary [y] and [ø] (umlauted from \*u and \*o) have merged with the original /y/ and /ø/.

Kalmyk (Bläsing, 2003) and Oirat (Birtalan, 2003) also have a contrast between palatalized vs. plain consonants. The original dentals \*t, \*d, \*n, \*l, \*r have been palatalized<sup>60</sup> under the influence of \*i: e.g., Kalmyk *u:tʃxn* < \**uyitakan* ‘rather small’ (Bläsing, 2003, p. 231), Spoken Oirat *u:lʃ* < \**u(x)uli* ‘sparrow owl’ (Birtalan, 2003, p. 214).<sup>61</sup>

<sup>60</sup> According to Svantesson et al. (2005, p. 211), however, Kalmyk has only two palatalized consonant phonemes: *nʃ* and *lʃ*.

<sup>61</sup> Note that in these lexical items the back vowel (/u:/) preceding a palatalized consonant is not umlauted. It has been noted that palatalized consonants block vowel umlaut (Kara, 2006, p. 103).

Admittedly, both vowel and consonant palatalization are diachronic and thus less convincing as evidence for the synchronic activeness of [coronal]. However, the creation of the new low front vowel /ɛ/ requires [coronal] to be active in the vowel phonology so that /ɛ/ can be distinguished from another low front unrounded vowel /e/: if we inadequately assume [-dorsal] as the palatalizing feature, /ɛ/ would be specified as [+low, -dorsal] which subsumes the feature specifications of /e/ (= [+low, -dorsal, -labial]). Therefore, we need [coronal] (at least for classificatory purposes), unless we introduce a different feature [high] (which is totally irrelevant to the palatalization facts) to make a three-way height distinction and distinguish /i/, /e/, and /ɛ/ by specifying them as [+high, -low], [-high, -low], and [-high, +low], respectively. Also, under the “[dorsal]” approach to palatalization, we might need a special treatment as to why other [-dorsal] vowels /e, y, ø/ do not palatalize preceding consonants and vowels.

Once [coronal] turns out to be available in the vowel system (for /ɛ/), it is reasonable to “re-use” this feature [coronal] for the feature specifications of the “umlauting” vowel /i/ as well.

One might claim that the umlauting feature is [-dorsal] rather than [+coronal] based on the following data which show that the vowel umlaut can change the vowel harmony class of the affected vowel.

(96) Change of vowel harmony class due to umlaut (Svantesson et al., 2005, p. 212ff.)

	Old Mong	Kalmyk	Baarin	Khalkha	Gloss
a. “front” vowel					
	*ker	ger-er	kɣr-ɣr	ger-er	‘house’
	*mør	mør-er	mor-or	mor-or	‘path’

*yke	yg-εr	uk-ʏr	ug-er	‘word’
b. “back” vowel				
*aman	am-ar	am-ar	am-ar	‘mouth’
*motun	mod-ar	mɔt-ɔr	mɔt-ɔr	‘tree’
*sur	sur-la	sʊr-la	sʊr-la	‘to learn’
c. fronted “back” vowel				
*amin	εm-εr	εm-ar	am <sup>i</sup> -ar	‘life’
*morin	mɔr-εr	mɔer-ɔr	mɔr <sup>i</sup> -ɔr	‘horse’
*uri	yr-lε	yr-la	ʊr <sup>i</sup> -la	‘invite’

Note in (96)c that the fronted “back” vowels in Kalmyk take front vowel suffixes rather than back vowel suffixes. A simplest explanation for this harmony class shift would be that these unlauded vowels have assimilated to the conditioning \*i with respect to [ $\pm$ dorsal], changing their value from [+dorsal] to [-dorsal].

However, the palatalizing effect of /i/ cannot be ascribed to a [-dorsal] specification, because /i/ is neutral to palatal harmony (97) (although it patterns as if it were a front vowel when it is the only vowel in a stem (98)). These facts indicate that /i/ is not likely specified for the harmonic feature ([-dorsal]): back vowels have the marked value ([+dorsal]) and trigger palatal harmony, whereas all remaining, non-back vowels including /i/ do not trigger harmony and thus take front vowel suffixes as a default rule.

- (97) The neutral vowel /i/ can co-occur with either front or back vowels in Written Oirat (Data drawn from Birtalan (2003, p. 213) and Rákos (2002) unless otherwise noted)

Front stems		Back stems	
šikyr	‘umbrella’	šidar	‘close’
čერიq <sup>62</sup>	‘army’	yuči/n	‘thirty’
šine	‘new’	čidal	‘ability, skill’
išegei	‘felt’	ǰiryal	‘happiness’
tyšimel	‘official’	u:ǰim	‘wide, spacious’
døčin	‘forty’	xani:dun	‘cough’
zerliq	‘wild’ (Krueger, 1978, p. 668)	zarliq	‘command’

- (98) /i/ patterns as a front vowel if it is the only vowel in a stem

- a. Kalmyk (Svantesson, 1985, p. 305)

ir-le <sup>63</sup>	‘come-NarrPast’	bič-le	‘write-NarrPast’
ičr-εs	‘shame-Abl’	ǰil-εs	‘year-Abl’

- b. Written Oirat (Data drawn from Rákos, 2002)

ǰil-dy	‘year-Dat’(p.20)	ki-qsen	‘to do-Nomen perfecti’ (p.20)
ijil-dy	‘Volga-Dat’(p.21)	biči-yl-ky	‘to write-Caus-Nomen futuri’ (p.35)

<sup>62</sup> According to Rákos (2002, p. 10), [g], [ɣ], and [q] are allophones of a single phoneme and are in complementary distribution: [g] as an onset consonant (velar) preceding a front vowel (including /i/), [ɣ] as an onset consonant (uvular) preceding a back vowel, and [q] as a coda consonant in both front and back words. Similar velar-uvular distinction can be found between [k] and [k’], although their pronunciation is not clearly described. /x/ seems to be treated as separate phoneme, although it appears in back vowel words only.

<sup>63</sup> Cyrillic Kalmyk orthography has no vowel length distinction in non-initial syllables, whereas Cyrillic Mongolian and Buriat write full non-initial vowels with double letters and reduced vowels with single letters (Svantesson et al., 2005, p. 40). Thus, I eliminated the length marks from the suffix vowels in Svantesson’s data for consistency’s sake, since other authors do not use length marks or double letters for similar Kalmyk suffixes.



Furthermore, there are contradictory descriptions which show that this vowel harmony class shift might not have taken place across the board. For example, Birtalan (2003, p. 213) presents some cases of “violation” of vowel harmony where an umlauted vowel takes the harmonizing suffix (back vowel suffix) that the original back vowel would take, e.g., SO *ε:l-ar* (< \**a(y)il-aar*) ‘camp-Inst’, SO *ø:rt.ul-* (cf. W.Mong *o(y)ira-ta-*) ‘to come closer-Caus.’<sup>64</sup>

The vowel harmony class shift data in (96) above may receive plausible explanation under the “two palatal feature” analysis I adopt here: The umlauted \**a* (/ε/) in Kalmyk is originally a “back” vowel ([+dorsal]) which used to take a “back” vowel suffix. The umlaut process spreads [+coronal] from /i/ to /a/, resulting in [+coronal, +dorsal] specification for /ε/. Putting aside the issue whether [+coronal, +dorsal] is logically impossible (as is [+high, +low]) or not, I assume that this combination is universally unpreferable since [+coronal] and [+dorsal] require the tongue body to move in the opposite directions (\*[+coronal, +dorsal]). In other words, [+coronal] implies [-dorsal] and [+dorsal] implies [-coronal]. This implicational relation is reminiscent of that between tongue root advancement/retraction and tongue body movement (Archangeli & Pulleyblank, 1994) introduced in §2.2.3.4.

One way to resolve the contradictory feature combination \*[+coronal, +dorsal] is for a feature to “override” the other, leaving the latter out of the feature specifications. Since [coronal] outranks [dorsal] in the contrastive hierarchy in Kalmyk, [+coronal] overrides [+dorsal], meaning that the vowel loses [+dorsal]. Then, it follows that it takes a [-dorsal] suffix as default.

---

<sup>64</sup> The etymology suggests that the fronted vowels in these examples are the result of coalescence: *ai* > *ε:* and *oi* > *ø:*. Andrew Joseph (p.c.) pointed out the possibility that it may only be in cases of coalescence, not in any true umlaut cases, that “back” vocalism is preserved.

Thus, we have two distinct features for the front-back dimension, [coronal] for palatalization/umlaut and [dorsal] for palatal harmony.

What if we choose one of these two, say [dorsal], and attempt a contrastive hierarchy with three features, [dorsal], [low], and [labial]? I will show that all the logically possible six contrastive hierarchies face a fatal problem.

#### **2.2.4.2. Why does a three-feature analysis fail?**

If we have three contrastive features, [dorsal] (or [coronal]), [low], and [labial], then there are six logically possible hierarchies.

- (99) Six logically possible contrastive hierarchy with [coronal], [low], and [labial]
- |                                |                                |
|--------------------------------|--------------------------------|
| a. [low] > [labial] > [dorsal] | d. [labial] > [dorsal] > [low] |
| b. [low] > [dorsal] > [labial] | e. [dorsal] > [low] > [labial] |
| c. [labial] > [low] > [dorsal] | f. [dorsal] > [labial] > [low] |

Among the above six, I will take only two hierarchies, (99)a and (99)b, to show how a three-feature analysis fails. The two hierarchies constitute two different types of wrong hierarchies, to which the other four possible hierarchies also belong.

Let us examine the hierarchy [low] > [labial] > [dorsal]. This hierarchy was proposed by Walker (1993) for both symmetrical and asymmetrical palatal systems. An example of the symmetrical palatal vowel system can be found in many Turkic languages. Below is the vowel system of Turkish, the standard representative of Turkic languages.

(100) A symmetrical palatal vowel system: Turkish

	Front		Back	
	unround	round	unround	round
High	i	y	ɨ	u
Low	ɛ	ø	a	o

The following contrastive hierarchy was proposed for Turkish (Walker, 1993, p. 183).

(101) Contrastive hierarchy for Turkish

a. SDA: [low] > [labial] > [dorsal]

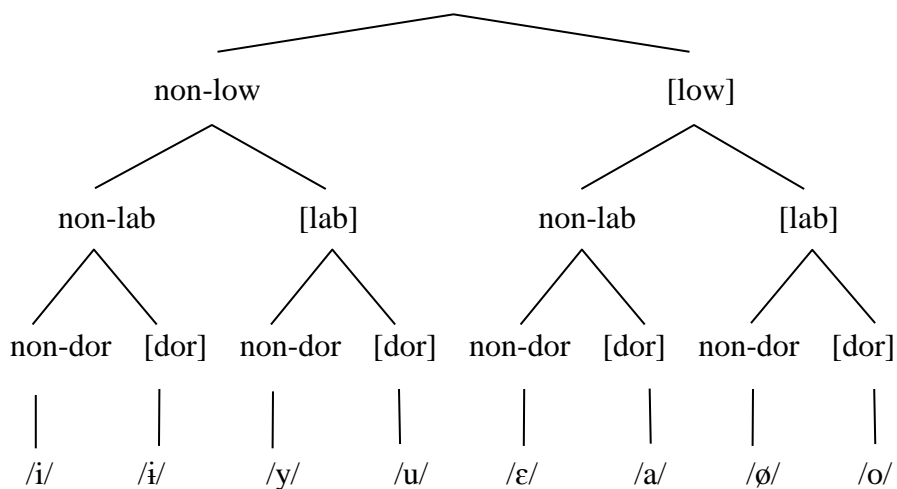

b. Output specifications

$$\begin{array}{l}
 /i/ = \begin{bmatrix} -\text{low} \\ -\text{labial} \\ -\text{dorsal} \end{bmatrix} \quad /y/ = \begin{bmatrix} -\text{low} \\ +\text{labial} \\ -\text{dorsal} \end{bmatrix} \quad /ɨ/ = \begin{bmatrix} -\text{low} \\ -\text{labial} \\ +\text{dorsal} \end{bmatrix} \quad /u/ = \begin{bmatrix} -\text{low} \\ +\text{labial} \\ +\text{dorsal} \end{bmatrix}
 \end{array}$$

$$\begin{array}{l}
 /ɛ/ = \begin{bmatrix} +\text{low} \\ -\text{labial} \\ -\text{dorsal} \end{bmatrix} \quad /ø/ = \begin{bmatrix} +\text{low} \\ +\text{labial} \\ -\text{dorsal} \end{bmatrix} \quad /a/ = \begin{bmatrix} +\text{low} \\ -\text{labial} \\ +\text{dorsal} \end{bmatrix} \quad /o/ = \begin{bmatrix} +\text{low} \\ +\text{labial} \\ +\text{dorsal} \end{bmatrix}
 \end{array}$$

However, in case of the symmetrical Turkish vowel system, all six logically possible hierarchies will give us the same output specifications. Thus, unless there are certain phonological patterns that favor one hierarchy over the others, I assume that all six hierarchies are acceptable.

By contrast, in case of an asymmetrical vowel system, hierarchical ordering of features is crucial to capture its phonological patterns. An example of the asymmetrical palatal vowel system can be found in Mongolic languages such as Kalmyk and Oirat.

The same contrastive hierarchy, [low] > [labial] > [dorsal], as in Turkish is given below.<sup>65</sup>

(102) Kalmyk/Oirat: alternative analysis with only three features (I)

a. SDA: [low] > [labial] > [dorsal]

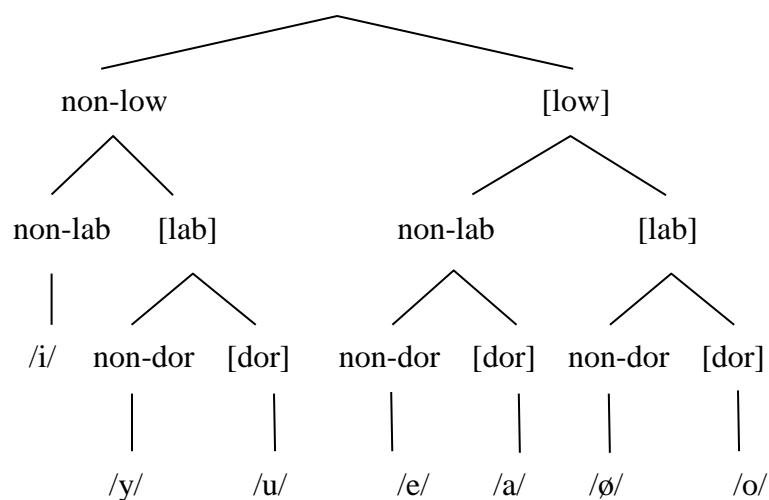

<sup>65</sup> Based on the description by Poppe (1960b, 1970), Walker (1993, pp. 190–2) proposes this contrastive hierarchy for the presumed-to-be “palatal” vowel system of Khalkha and Buriat. However, since this analysis was attempted for an asymmetrical vowel inventory with palatal harmony, I apply it to Kalmyk/Oirat here as a less desirable alternative.

b. Output specifications

/i/ = [-low, -lab]	/y/ = [-low, +lab, -dor]	/u/ = [-low, +lab, +dor]
	/ø/ = [+low, +lab, -dor]	/o/ = [+low, +lab, +dor]
	/e/ = [+low, -lab, -dor]	/a/ = [+low, -lab, +dor]

The above hierarchy captures the neutrality of /i/ to palatal harmony by ranking [labial] over [dorsal]: although it is phonetically a front vowel, /i/ lacks the specification for [dorsal], thus failing to trigger harmony and co-occurring with both front and back vowels.

However, the proposed hierarchy fails to explain the vowel umlaut triggered by /i/ because /i/ lacks [-dorsal] specification. One might assume that the feature specification responsible for the palatalizing effect of /i/ may be introduced later by a redundant rule. This assumption, however, adds undesirable complications to phonological theory since it requires redundant features to be active in phonological patterning. The hierarchy [labial] > [low] > [dorsal] (99)c also has the same problem.

Now let us examine another type of problem. This time we have the contrastive hierarchy, [low] > [dorsal] > [labial] (99)b.

(103) Kalmyk/Oirat: alternative analysis with only three features (II)

a. SDA: [low] > [dorsal] > [labial]

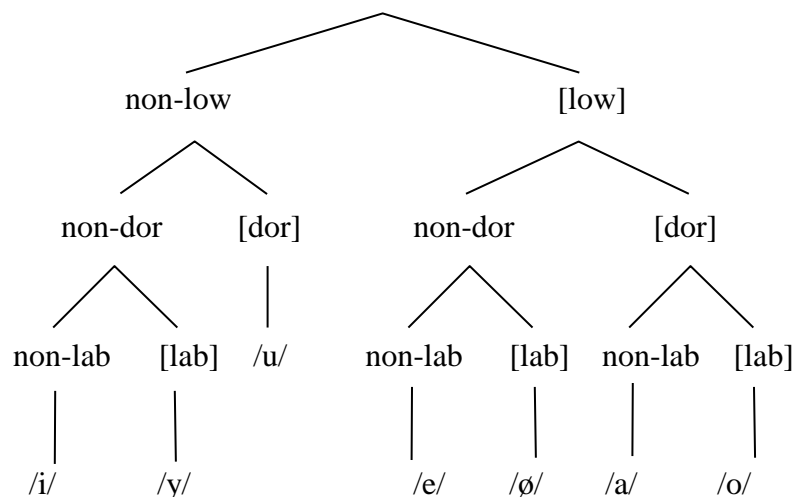

b. Output specifications

/i/ = [-low, -dor, -lab]	/y/ = [-low, -dor, +lab]	/u/ = [-low, +dor]
/e/ = [+low, -dor, -lab]	/a/ = [+low, +dor, -lab]	
/ø/ = [+low, -dor, +lab]	/o/ = [+low, +dor, +lab]	

The problem with this type of contrastive hierarchy is that there appears a pair of vowels whose harmonic relation cannot be represented properly. In (103), for example, /y/ and /u/ do not form a harmonic pair, although they should. And there is no morphological reason to group /i, y, u/ together, either. The remaining three other hierarchies, (99)d [labial] > [dorsal] > [low], (99)e [dorsal] > [low] > [labial], and (99)f [dorsal] > [labial] > [low] also have a problem of the same sort.

Therefore we conclude that Oirat type languages require four contrastive features including two distinct features in the front-back dimension. Also, it is obvious in terms of the structure of contrastive hierarchy that Oirat is much closer to Khalkha than to Turkish.

### 2.2.5. *Interim summary*

The interim summary given below shows that all 11 Mongolic languages belong to one of the four subtypes differentiated from one another on the basis of the contrastive hierarchy analysis proposed so far.

#### (104) Mongolic vowel systems: contrastive hierarchy analysis

Type	Contrastive hierarchy	Language
Type I	[cor] > [low] > [lab] > [RTR]	Mongolian Proper (e.g., Khalkha)
Type II	[cor] > [low] > [lab] (> [RTR])	Monguor, Santa, Bonan, Moghol, Shira Yugur, Kangjia
Type III	[cor] > [lab] > [RTR] (> [low])	Dagur, Buriat, Khamnigan
Type IV	[cor] > [low] > [lab] > [dorsal]	Kalmyk/Oirat

### 2.3. Historical development of Mongolic vowel systems

In this section, we will revisit the so-called Mongolic Vowel Shift hypothesis (Svantesson, 1985, 1995) and propose a new scenario for the vocalic history of the Mongolic languages based on the contrastive hierarchy analyses provided in the previous section.

Svantesson (1985) followed the traditional assumption that Old Mongolian had a palatal system and proposed that there was a shift from Old Mongolian palatal system to modern Mongolic pharyngeal (RTR) system. However, since there is no actual phonetic evidence that Old Mongolian had a palatal system, it is equally reasonable to assume that Old Mongolian had an RTR system as many modern Mongolic languages do. I will argue that the latter view is more plausible in terms of the comparative methods. The modern palatal system found only in Kalmyk and Oirat, then, can be viewed as a result of the shift in the opposite direction, namely, the shift from RTR to palatal system.

Before we go over the Mongolic Vowel Shift, let us first familiarize ourselves with various terms proposed to refer to the Mongolic languages at earlier stages.

*Proto-Mongolic* is defined as “the technical term for the common ancestor of all the living and historically attested Mongolic languages” (Janhunen, 2003a, p. 1). By definition, it is the Mongolic language that was spoken at a time before the differentiation of the present-day Mongolic languages or in other words “before the geographical dispersal of the ancient Mongols under Chinggis Khan and his heirs”. The extralinguistic factors cited by Janhunen suggest that Proto-Mongolic dates back to thirteenth century.<sup>66</sup>

---

<sup>66</sup> Janhunen (2003a, p. 2f.) also suggests the subdivision into *Pre-Proto-Mongolic*, *Proto-Mongolic*, and *Post-Proto-Mongolic*. *Pre-Proto-Mongolic* is defined as “a conglomeration of geographically dispersed tribal idioms” before Chinggis Khan. The unification of Mongolic tribes by Chinggis Khan brought



(105) Pre-modern Mongolic vowel systems

a. Proto-Mongolic (Janhunen, 2003a, p. 4)

*i	*ü	*u
	*ö	*o
	*e	*a

b. Old Mongolian (Svantesson et al., 2005, p. 111)

	Front	Back
High	i y	u
Nonhigh	e ø	a o

Old Mongolian is defined in Svantesson et al. (2005, p. 98) as the immediate ancestor language that can be reconstructed from documents written in four different scripts: Uigurs, Chinese, Arabic, and 'Phags-pa (also Romanized as vPhags.pa or ḥP'ags-pa) in the thirteenth to the fifteenth centuries. The difference between Proto-Mongolic and Old Mongolian is that only the four aforementioned sources are used in the reconstruction of Old Mongolian whereas it is 'all the living and historically attested Mongolic languages' that are used in the reconstruction of Proto-Mongolic (Svantesson et al., 2005, p. 98f.).

Middle Mongol (Rybatzki, 2003a) and Middle Mongolian (Poppe, 1955, p. 15; Vladimircov, 1929, p. 47) are also used in basically the same meaning as Old

---

intensive linguistic unification which yielded a more homogeneous *Proto-Mongolic* language as a result. Then, *Proto-Mongolic* yielded a number of *Post-Proto-Mongolic* dialects from which the Modern Mongolic languages descend. Janhunen assumes \*i̯, the back counterpart to \*i, in Pre-Proto-Mongolic to explain the neutrality of \*i with respect to the putative "palatal" harmony in Proto-Mongolic. cf. Pritsak (1964). See Svantesson et al. (2005, pp. 117, 224) for further discussion.

Mongolian, although there are slight differences with respect to the coverage of the written texts.

Classical Mongolian (also known as Written or Literary Mongol(ian)) is the written language which has been used since about the thirteenth century and is still used by the Mongols of Inner Mongolia, China (Janhunen, 2003d; Poppe, 1955; Svantesson, 1985).

There are also other terms such as “Common Mongolian” and “Ancient Mongolian” (Poppe, 1955, p. 15).

Despite the different names and definitions (e.g., Proto-Mongolic, Old Mongolian, Middle Mongolian, Classical/Written/Literary Mongolian), all pre-modern Mongolic languages are believed, by most Mongolists, to share the same type of vowel system with the same type of vowel harmony: a 7-vowel system with palatal harmony given above.<sup>67</sup> This palatal analysis of Old Mongolian is considered to be “fairly uncontroversial” (Svantesson et al., 2005, p. 111). Only a few scholars pursue different ideas. Some Mongolian-Chinese scholars such as Kögjiltü (1982), Cenggeltei (1985, p. 24) reconstruct a five-vowel system (/ \*i, \*e, \*a, \*u, \*o/) for Old Mongolian which is similar to that in Monguor. Li (1996) for Old Mongolian and Kögjiltü (1986 et seq.) for Middle Mongolian assume a tongue root-based seven-vowel system similar to that of modern Mongolian (Svantesson et al., 2005, p. 224).<sup>68</sup>

---

<sup>67</sup> See Svantesson et al.(2005, p. 224) for a comprehensive list of this sort of previous works.

<sup>68</sup> Svantesson et al. (2005) introduced this “tongue root” approach in the Appendix, not seriously considering it as an alternative to his (conventional) “palatal” approach to Old Mongolian vowels.

### 2.3.1. *The Mongolic Vowel Shifts hypothesis*

The prevailing view that Old Mongolian had a palatal system seems to have influenced (or reversely, been influenced by) the palatal analysis of modern languages. Modern Mongolic languages have also been assumed by many Mongolists (e.g., Poppe, 1955) to have a palatal system, although subtle phonetic differences have sometimes been noted.<sup>69</sup> Mongolian (esp. Khalkha) vowel harmony has attracted attention of theoretical phonologists and, thus, has provoked much debate.<sup>70</sup> However, the palatal analysis of modern Mongolian languages (except for Kalmyk/Oirat) was proved to be incorrect by Svantesson’s (1985, 1995) acoustic studies which show that Khalkha and other Mongolian dialects have a “pharyngeal” (= tongue root), not a palatal, harmony system.<sup>71</sup> Hence, most of the earlier works may well be criticized as an analysis of “a non-existing ‘Khalkha’” (Svantesson, 1985, p. 287).

As we have seen in the previous section, we find at least four different types of vowel systems in modern Mongolic languages including both the RTR system of Mongolian Proper and the palatal system in Kalmyk/Oirat.

#### (106) Modern Mongolic varieties

a. Khalkha	b. Monguor	c. Dagur	d. Kalmyk/Oirat
i      u	i      u	i      u	i    y    u
	ɯ      e      o	ə	e    ø    o
e      o	a	a    ɔ	ɛ      a
a    ɔ			

<sup>69</sup> According to Poppe (1955), \*ö is realized as [v̥], a sound between a high-mixed-wide-round and mid-mixed-narrow-round” (p. 48), and \*ü as [u], a “high-mixed-narrow-round” (p. 50) in Khalkha.

<sup>70</sup> See Svantesson et al. (2005, p. 222) for a list of such theoretical approaches.

<sup>71</sup> See also Cenggeltei (1959, 1963) and Cenggeltei & Sinedke (1959) for earlier tongue root-based treatments of Mongolian vowel harmony.

Then, how has the OM palatal system evolved into the variety of modern systems?  
 Svantesson's (1985) answer is the Mongolic Vowel Shift hypothesis (the MVS henceforth), illustrated in (107), which holds that all Mongolic languages but Kalmyk/Oirat have undergone vowel shifts consisting mainly of *velarization* and *pharyngealization* and, as a result, vowel harmony shift from palatal to RTR harmony.

(107) Mongolic Vowel Shift hypothesis (Svantesson et al., 2005, p. 181)

a. Monguor type: Monguor, Santa, Bonan, Moghol

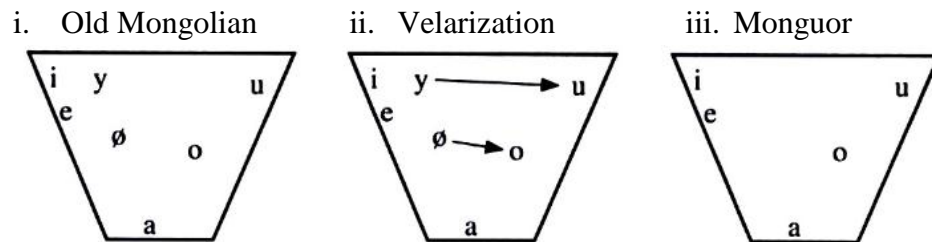

b. Mongolian type: Mongolian Proper, Buriat, Khamnigan, Shira Yugur, Kangjia

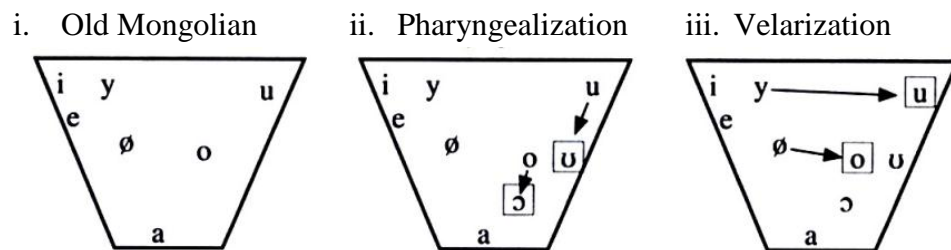

iv. Khalkha

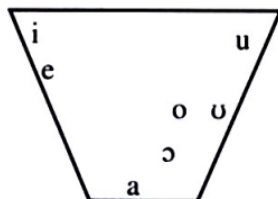

c. Dagur type: Dagur

i. Old Mongolian

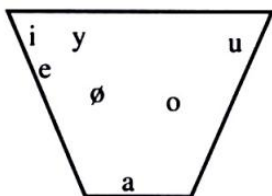

ii. Pharyngealization

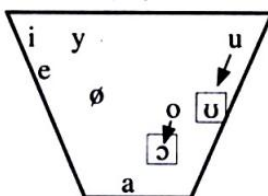

iii. Velarization

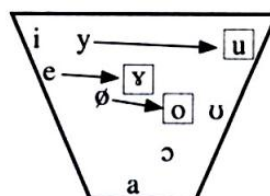

iv. Polarization

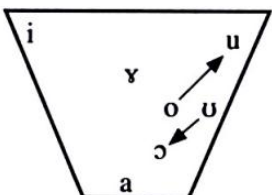

v. Dagur

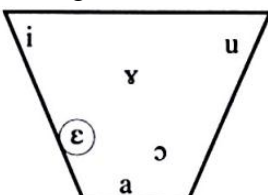

(The symbol ‘ɣ’ corresponds to ‘ə’ in my analysis.)

According to the MVS as above, the changes in the Monguor type languages in (a) are accounted for by *velarization* of the ‘front’ rounded vowels \*y and \*ø and their subsequent mergers with their harmonic pairs \*u and \*o. The Mongolian type languages in (b) are claimed to have undergone the palatal-to-RTR shift as a result of *pharyngealization* and *velarization*. Dagur in (c) is assumed to have experienced further change *polarization* in addition to *pharyngealization* and *velarization* which resulted in the merger between the two “back” rounded vowels \*u and \*o as well as between the two “front” rounded vowels \*y and \*ø. Kalmyk/Oirat, which is not shown in the above illustration, is believed to retain the Old Mongolian vowel system with palatal harmony.

The assumption that Old Mongolian had a palatal system, however, has never been proven in a rigorous sense. As Svantesson and his colleagues acknowledged, the assumption receives only incomplete support from the written sources which serve as the basis of the reconstruction of Old Mongolian: none of the harmonic vowel pairs

are distinguished in non-initial syllables (except for *a* and *e* in Sino-Mongolian and 'Phags-pa Mongolian) (Svantesson et al., 2005, p. 113). More crucially, how can we be sure about the assumed vowel qualities of the written sources? It seems to me that the vowel letters of, e.g., 'Phags-pa and Uyghur scripts are treated as if they were phonetic symbols. However, there appears to be no evidence in the Old Mongolian texts written in Uyghur, 'Phags-pa, Arabic, and Chinese Mongolian which decisively identifies the phonetic quality of the Old Mongolian vowels (Hattori, 1975, p. 14ff.; J. Kim, 1993, p. 40). On the contrary, the actual phonetic quality of each letter in the aforementioned scripts is yet to be reconstructed based on spoken languages. As Campbell (2004, p. 369) points out, “the written records for historical linguistic interests are only as valuable as our ability to interpret them and to determine accurately the phonetic and structural properties of the language which they represent.”

In the next section, we will reconstruct the Old Mongolian vowel system applying the standard method of historical linguistics, the comparative method, to the modern *spoken* Mongolic varieties rather than *written* sources, bearing in mind that “the most reliable evidence is contemporary, not ancient” (Martin, 2000, p. 29). The result will dramatically change our view on the Old Mongolian vowel system and the Middle Korean vowel system as well (cf. §3.5).

### 2.3.2. An RTR analysis of Old Mongolian

Contra Svantesson (1985) and most other Mongolists, I reconstruct an RTR-based 7-vowel system rather than a palatal system for Old Mongolian (cf. Li 1996).

(108) An RTR analysis of the OM vowel system

	Front	Back		
High	i	u	NonRTR	
	(i)	ʊ	RTR	
Low		ə	o	NonRTR
		a	ɔ	RTR

Vowels are divided into three sets: non-RTR vowels /ə, u, o/, RTR vowels /a, ʊ, ɔ/, and a neutral vowel /i/.<sup>72</sup>

I assume that the non-RTR counterpart to \*a was \*ə, not \*e (Nangrub, 1981; Yilinzhen [Irincin, Yekeminggadai], 1976), although it has been normally rendered as \*e in the literature based on the palatal assumption. Indeed, there are many modern

---

<sup>72</sup> It could be the case that Old Mongolian (and Proto-Mongolic as well) had two high front vowels, non-RTR \*i and RTR \*i. There is indication for the existence of two i's in Old Mongolian. In Uyghur Mongolian, for example, \*/k<sup>hi</sup>/ was rendered as <qi> in RTR words and as <ki> in non-RTR words. The two distinct letters <q> and <k> can be interpreted to represent the two allophones, uvular \*[q<sup>h</sup>] and velar \*[k<sup>h</sup>], of a single phoneme \*/k<sup>h</sup>/, which are conditioned by the RTR-ness of the following homosyllabic vowel (Svantesson et al., 2005, p. 117). This uvular-velar distinction before <i> is found in Arabic Mongolian and, less consistently, in 'Phags-pa Mongolian as well (Svantesson et al., 2005, p. 117f.). Later in Classical Mongolian, <qi> is replaced by <ki>, which can be interpreted to indicate that RTR \*i merged with non-RTR \*i. Then, it follows that the existence of /i/ and /i/ in Chakhar can be viewed as the retention of the phonemic distinction, not as the result of splitting \*i (contra Svantesson et al., 2005, p. 182f.). This view seems quite reasonable considering the same merger pattern in Tungusic (e.g., Xunke Oroqen) as described in Li (1996, pp. 143&319) and Middle Korean as claimed by Park (1994). Although I limit myself to point out the possibility of reconstructing two i's here, note the difference between the traditional reconstruction and mine: many Mongolists, e.g., Poppe (1955, p. 24f.), guided by their conventional view that Old Mongolian had a palatal harmony, reconstruct a high "back" unrounded \*i instead of high front 'RTR' \*i.

Mongolic languages that retain the Old Mongolian pronunciation of this vowel: Chakhar and Dagur among others. The fronting of \*ə to /e/ in other modern Mongolic languages (e.g., Khalkha) does not affect its phonological behavior. Thus, it can be interpreted as a phonetic change induced by the preference for maximal distribution of vowels in the auditory space (Flemming, 2002; Kiparsky, 2003; Liljencrants & Lindblom, 1972) and the sparseness of vowels in the front region. The implicational relation between tongue root movement and tongue body movement may also be a factor. This will be further discussed later.

### 2.3.2.1. The contrastive hierarchy of Old Mongolian

I propose the following contrastive hierarchy for Old Mongolian.

(109) Contrastive hierarchy for Old Mongolian

a. SDA: [coronal] > [labial] > [RTR] > [low]

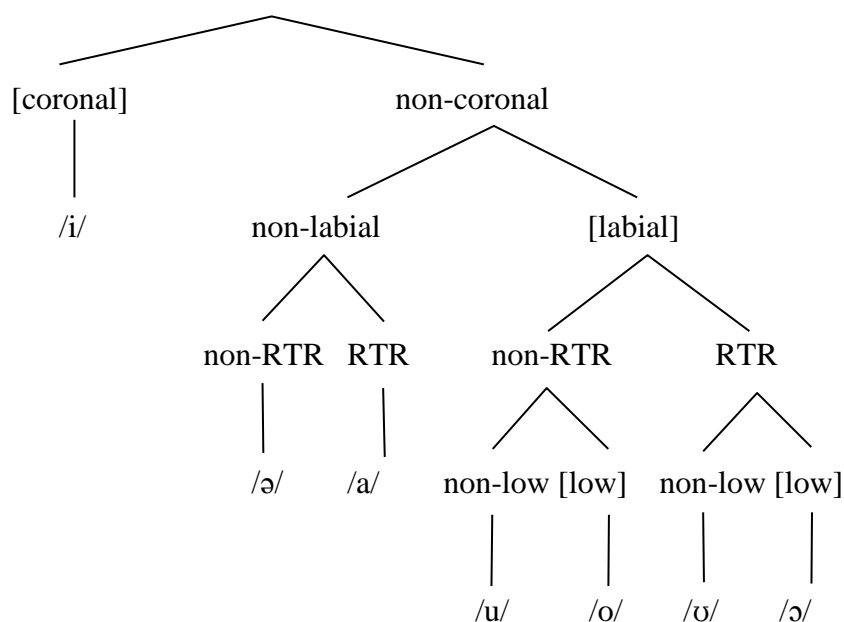



b. Output specifications

/i/ = [+cor, -RTR]

/u/ = [-cor, +lab, -RTR, -low]

/ɔ/ = [-cor, +lab, +RTR, -low]

/ə/ = [-cor, -lab, -RTR]    /o/ = [-cor, +lab, -RTR, +low]

/a/ = [-cor, -lab, +RTR]    /ɔ/ = [-cor, +lab, +RTR, +low]

Note that, although the proposed vowel inventory of Old Mongolian is almost identical to that of Mongolian Proper, the proposed hierarchy is closer to that of Type III (Dagur type) languages wherein [low] is ranked at the bottom of the hierarchy.

The phonological patterns that support this contrastive hierarchy analysis are summarized below:

(110) Evidence for the contrastive status of the proposed features in Old Mongolian

- a. [coronal] palatalization and/or umlaut pervasive in all Mongolic languages
- b. [labial] labial attraction and regressive labialization
- c. [RTR] RTR harmony
- d. [low] labial attraction is restricted to low vowels

Evidence for [coronal] comes from the palatalization and the vowel umlaut which are pervasive in the whole Mongolic family. Evidence for [RTR] comes from RTR harmony. See Svantesson et al. (2005, p. 114) for the basic patterns, although they view the Old Mongolian vowel harmony as a palatal one. Evidence for [labial] comes from a licensing distribution for rounded vowels, called *labial attraction*, as well as a regressive labialization (rounding assimilation). There is no labial harmony which affects the suffixal alternations in Old Mongolian, however (Svantesson et al., 2005, p. 115).

Labial attraction constrains the occurrence of low rounded vowels in a non-initial syllable of a root to occur only when the initial syllable also contains a low rounded vowel (Svantesson et al., 2005, pp. 114–5, 194; Walker, 2001, p. 837).

In the regressive labialization cases, an initial *\*ə* (*\*e* in Svantesson’s view) is rounded by a following *\*u* (*\*y* in Svantesson’s view). The reflexes of this process are found in Kalmyk, Buriat, Khamnigan, and Mongolian Proper (Khalkha).

(111) Regressive labialization in Old Mongolian (Svantesson et al., 2005, p. 194ff.)

Old Mong	Kalmyk	Khalkha	Buriat	Khamnigan	Gloss
*emys (əmus)	øms	oms	umdə	umut	‘to wear’
* <sup>h</sup> emyr (t <sup>h</sup> əmur)	t <sup>h</sup> ømr	t <sup>h</sup> omor	t <sup>h</sup> umər	t <sup>h</sup> umur	‘iron’

This gives us a clue as to the relative scope between [low] and [labial]. Since the labialization is triggered by a “high” rounded vowel *\*u*, *\*u* must bear a contrastive [+labial] value. In order for *\*u* to receive the [+labial] specification, [labial] should take scope over [low], thus [coronal] > [labial] > [RTR] > [low]. This ordering is supported also by one of the Old Mongolian writing systems: Uyghur Mongolian does not distinguish the high and low rounded vowel pairs in any positions, whereas it does distinguish the non-RTR and RTR vowel pairs at least in initial positions. The RTR contrast in vowels is also identifiable by other clues such as the usage of different consonant letters for velar vs. uvular allophonic distinction conditioned by non-RTR vs. RTR vowels respectively.

Then, how can we explain the change of contrastive hierarchy from [coronal] > [labial] > [RTR] > [low] in Old Mongolian to [coronal] > [low] > [labial] > [RTR] in Mongolian Proper (e.g., Khalkha)? An explanation can be drawn from the labial harmony facts. At first, the high vs. low contrast was only relevant to the distinction

between high vs. low rounded vowels. As low rounded vowels started to trigger labial harmony for better perceptability (Kaun, 1995), whereby the feature [labial] of \*o and \*ɔ spread to non-labial \*ə and \*a, and created four-way suffixal alternations, it became necessary to form a natural class out of these vowels within which \*ə and \*a contrast with \*o and \*ɔ as non-labial vs. labial counterparts. This may have triggered the re-ordering of the contrastive features accordingly, the *promotion* of [low] in particular, so that \*ə and \*a acquire the status of contrastively low vowel with the contrastive specification [+low].

### 2.3.2.2. The comparative method

To justify my reconstruction of Old Mongolian as an RTR system, let us compare the modern reflexes of Old Mongolian vowels. The following are the vowel correspondences in the modern Mongolic languages, slightly modified from Svantesson et al. (2005, p. 180).<sup>73</sup>

(112) Vowel correspondence (modified from Svantesson et al. 2005, p. 180)

Khalkha	a	ɔ	ʊ	e <sup>74</sup>	o	u	i
Chakhar	a	ɔ	ʊ	ə	o	u	i, ɪ
Baarin	a	ɔ	ʊ	ə	o	u	i
Shira Yugur	a	ɔ	ʊ	e	ø	u	ə
Kangjia	a	ʊ, ɔ	ʊ	e	o, u	u	i

<sup>73</sup> The modification I made to Svantesson et al.'s original correspondence set includes the elimination of Shira Yugur to avoid unnecessary complication, the replacement of the symbol *r* with *ə*, and the reinterpretation of the phonetic value of the vowel corresponding to OM \*e (from [e] to [ə] in Bonan and Santa). and the addition of /ɪ/ to /i/ in Chakhar.

<sup>74</sup> Here I replaced [i] with [e]. Recall that, although Svantesson et al. (2005, p. 6) reported a merger between the short vowels /i/ and /e/ in Khalkha, I prefer to treat them as distinct qualities. Refer back to §2.2.1.1. for the detail.

Monguor	a	o	u, o	i, e	o, u	u	i
Bonan	a	o	u	ə	o	u	i, ʉ
Santa	a	o	u	ie, ə	o	u	i
Moghol	a, o	o	u	e	o	u	i
Buriat	a	ɔ	ʊ	e	u	u	i
Khamnigan	a	ɔ	ʊ	e	u	u	i
Dagur	a	ɔ	ɔ, wa	ə	u	u	i
Kalmyk	a	o	u	e	ø	y	i

Now that we have this correspondence set, let us compare my RTR analysis with the traditional palatal analysis with respect to the basic principles of the comparative method: *majority-wins*, *economy*, and *naturalness/directionality* (Campbell, 2004, p. 131ff.).

First of all, a simple application of the “majority-wins” principle produces the following reconstruction of OM vowels:

(113) Reconstruction of OM by the application of “majority-wins” criterion

OM	*a	*ɔ	*ʊ	*e	*o	*u	*i
----	----	----	----	----	----	----	----

This reconstruction is almost identical to my reconstruction, except for \*e which will be discussed more later. This is a natural outcome, given the fact that the majority of languages have RTR harmony or its residue. On the contrary, a palatal system is not preferred because among the modern varieties only Kalmyk has this type of system.

Second, and more importantly, the criterion of “economy” which prefers the alternative with the fewest independent changes favors an RTR analysis over a palatal analysis. Here is a simplified representation of the development of the Mongolic

vowel systems based on the four types of modern Mongolic varieties recognized by a contrastive hierarchy analysis in the previous section.

(114) Economy

a. RTR analysis: only one change (RTR-to-palatal shift) in Kalmyk/Oirat

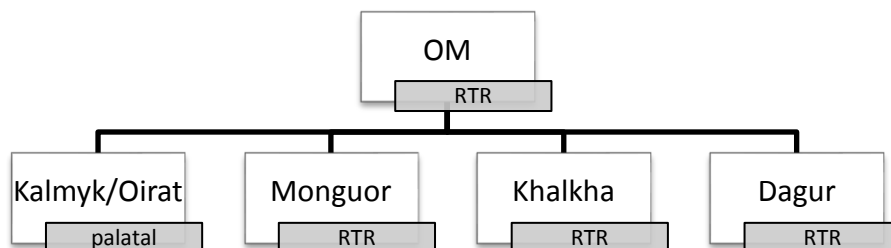

b. Palatal analysis: three independent changes (palatal-to-RTR shift)

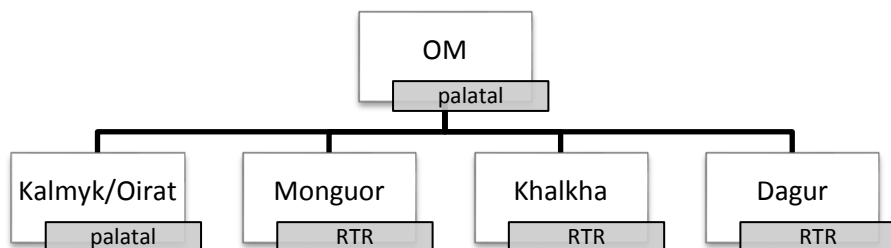

The reconstruction of Old Mongolian as an RTR system would require only one change (RTR-to-palatal shift) in Kalmyk/Oirat type languages, whereas the traditional reconstruction of Old Mongolian as a palatal system would require three independent changes (palatal-to-RTR shift) in all Mongolic languages other than Kalmyk/Oirat type, i.e., Monguor, Khalkha, and Dagur type languages. Hence, the former is more economical, and thus preferable, than the latter.

Note that the above representation makes no assumption on the history of branching. The point made here will still be maintained (or will become more evident) when we compare the two approaches with a more realistic tree: since, in many previous Mongolic classifications, Kalmyk/Oirat is grouped together with Mongolian

Proper deep down in the tree, a palatal analysis of OM would demand that the putatively original palatal contrast should be shared by both Kalmyk/Oirat and many non-Oirat type languages at certain branching-off points. Therefore, we would need multiple occurrences of palatal-to-RTR shifts. On the other hand, an RTR analysis of OM would require only one RTR-to-palatal shift.<sup>75</sup> This is illustrated below, taking Nugteren’s classification as example:

(115) Nugteren (1997, p. 215), as cited in Indjieva (2009, p. 192)

a. RTR analysis (more economical)

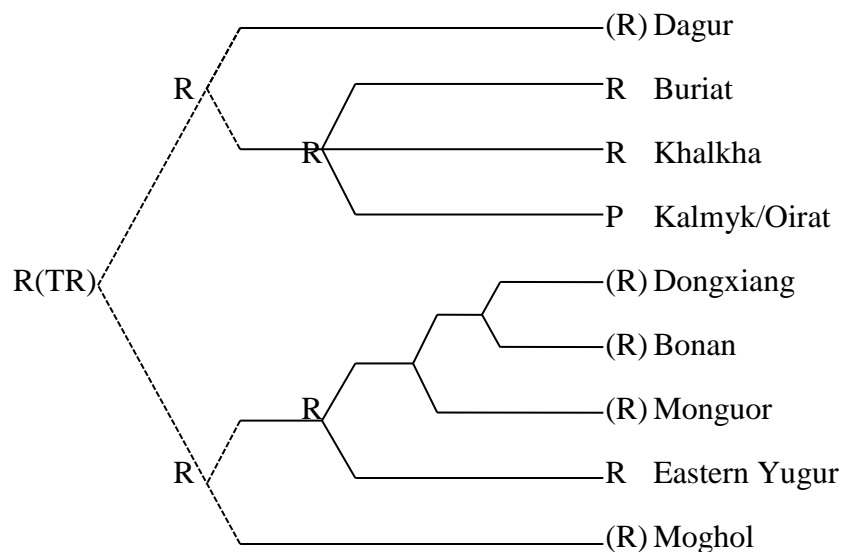

<sup>75</sup> This reasoning, however, reflects the general tendency in relatively recent classifications. On the contrary, one might assume that all non-Oirat type languages (that is, Dagur, Khalkha, and Monguor type languages) “constitute an old clade that split later after a ‘single-event’ shift from palatal to RTR contrast” (Andrew Joseph, p.c.). This is reminiscent of some of the earlier classifications (Vladimircov, 1929; Poppe, 1955; Doerfer, 1964).

b. Palatal analysis (less economical)

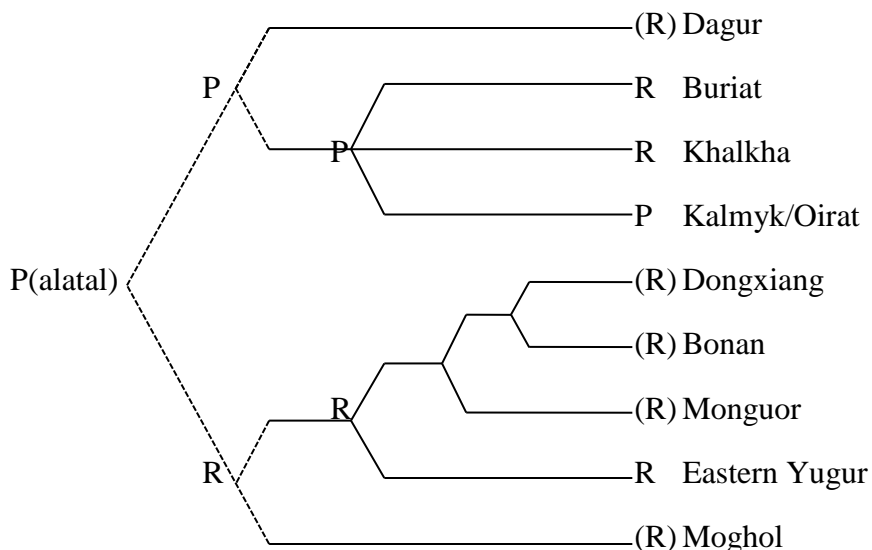

Finally, the third criterion, “naturalness” (or “directionality”), also favors an RTR analysis to a palatal analysis of Old Mongolian. As pointed out by Vaux (2009), there are no known phonetic principles that support Svantesson’s palatal-to-RTR shift, whereas the reverse shift from RTR to palatal contrast is phonetically grounded.<sup>76</sup> The phonetic grounds of the RTR-to-palatal shift can be found in both articulation and perception. First, it is well-known that tongue body movement is concomitant with tongue root movement (Archangeli & Pulleyblank, 1994; Lindau, 1975, among many others) as schematized below:

---

<sup>76</sup> Vaux (2009) uses [ATR]. This, however, will not affect the main points in our discussion here.

(116) Tongue root advanced → tongue body pushed up and forward (Vaux, 2009)

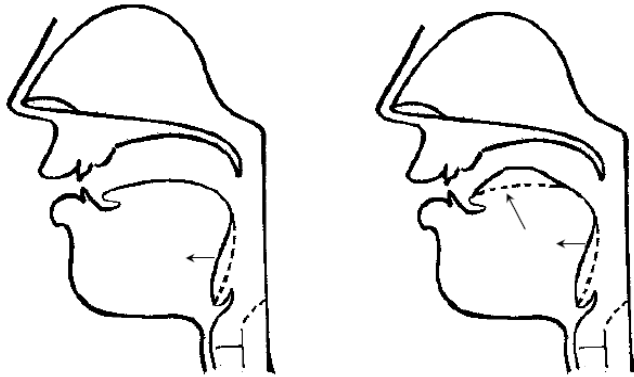

The RTR-to-palatal shift can also be viewed as a *simplification* from a system with more marked (whether typologically or structurally) feature, i.e., tongue root feature, to a system with less marked one, i.e., tongue body feature (Vaux, 2009). Viewing the reverse shift as a simplification may also be reasonable in terms of the complexity of articulatory gestures involved: it may be the case that the RTR configuration in Mongolic exploits pharyngeal wall constriction and related muscle activities involving epiglottis and aryepiglottic folds/sphincter (cf. Edmondson & Esling, 2006).

Second, Kiparsky's hypothesis that "vowel shifts are the result of a tendency to maximize perceptual distinctness" (Kiparsky, 2003, p. 335) also prefers the RTR-to-palatal shift analysis since the fronting of vowels can be viewed as an enhancement of the perceptability by maximizing the F2 difference among the original back vowels.

It should be noted that Svantesson's MVS constitutes a counterexample to the Labovian principles of vowel shifting. Specifically, the assumed *velarization*<sup>77</sup> in the MVS by which the original front vowels move backward incurs a violation of Principle III.

---

<sup>77</sup> Another problem of *velarization* is that it has no empirical basis to account for the velar-uvular distinction in the consonant system of Monguor type languages.



(117) The Labovian principles of vowel shifting (Labov, 1994, p. 116)

- a. PRINCIPLE I        In chain shifts, long vowels rise.
- b. PRINCIPLE II       In chain shifts, short vowels fall.
- c. PRINCIPLE II<sub>A</sub>     In chain shifts, the nuclei of upgliding diphthongs fall.
- d. PRINCIPLE III      In chain shifts, back vowels move to the front.

What is worse is that this unnatural, counter-exemplary change should have taken place in all Mongolic varieties other than Kalmyk/Oirat. By contrast, under the RTR analysis of Old Mongolian and the ensuing RTR-to-palatal shift hypothesis, the assumed original non-RTR back vowels in Old Mongolian (\*u, \*o) are considered to have moved to the front (only in Kalmyk/Oirat), which conforms to the Labovian principles.

There are no known cases in which a palatal system has developed into a tongue root system. On the contrary, there are cases involving the shift in the opposite direction: e.g., Somali (B. L. Hall et al., 1974, p. 260, as cited in Vaux 2009), Louisiana English (Vaux, 2009), and Romance languages (Calabrese, 2000). For example, in Somali which has ATR harmony, [+ATR] vowels /u/ and /o/ surface as more fronted vowels [y] and [ø].

(118) Somali vowel system (B. L. Hall et al., 1974, p. 260)

[+ATR]		[-ATR]	
i	y	ɪ	ʊ
e	ø	ɛ	ɔ
a			

Louisiana English, where the [+ATR] vowel /u/ has more fronted surface value [ɯ] or [y], is another case that shows this conversion from [αATR] to [-αback] (Vaux, 2009), although it is not a vowel harmony system.

(119) Louisiana English (Vaux, 2009)

Standard English	Dialects	Gloss
[but]	[bʊt], [byt]	‘boot’
[p <sup>h</sup> ʊt]	[p <sup>h</sup> ʊt]	‘put’

Calabrese (2000) also illustrates a case of Romance vowel fronting in an Italian dialect the account of which relies on the feature [+ATR]. In the Pugliese dialect of Altamura (a southern Italian), ATR vowels /u, o/ undergo fronting in certain contexts, whereas non-ATR vowel /ɔ/ does not.

(120) Vowel fronting in Altamura (a Romance) (Calabrese, 2000, p. 62f.)

a. /u/ → [y]	/ˈursə/	→	[ˈyrsə]	‘bear’
	/ˈʃʊŋŋə/	→	[ˈʃyŋŋə]	‘rush’
b. /o/ → [ø]	/ˈtɔstə/	→	[ˈtøstə]	‘hard.fem.’
	/ˈommə/	→	[ˈømmə]	‘man’
c. /ɔ/: no fronting	/ˈstɔppə/	→	[ˈstɔppə]    * [ˈstœppə]	‘tow’
	/ˈdɔlfə/	→	[ˈdɔlfə]    * [ˈdœlfə]	‘sweet’

All the above considerations with regard to the “naturalness” or “directionality” favor my RTR-to-palatal shift approach over Svantesson’s palatal-to-RTR shift approach.<sup>78</sup>

<sup>78</sup> In addition to the above cases, the Southwest Turkic voicing case is highly noteworthy. As shown

Recall that I reconstruct \*ə, not \*e, for Old Mongolian, although the “majority wins” guideline (and maybe “economy” as well) of the comparative method would favor \*e. This is because I put ‘naturalness’ ahead of the other two principles. Here, the same articulatory, perceptual, and typological considerations are in effect as I reconstruct \*u and \*o rather than \*y and \*ø for Old Mongolian.

### 2.3.2.3. Textual evidence in favor of RTR analysis

There are two pieces of philological evidence which support the RTR analysis presented in this thesis. One is from Chinese transcriptions and the other from Korean transcriptions of Mongolic words.

---

below, in Southwest Turkic languages (also known as Oghuz: Turkish, Gagauz, Azeri, Turkmen), voiceless stops became voiced before front vowels (Vaux, 2009).

#### Southwest Turkic consonant voicing (Vaux, 2009)

Proto-Turkic		Turkish	Proto-Turkic		Turkish
*kara	‘black’	kara	*taŋ	‘dawn’	tan
*kæ l-	‘come’	gel-	*tæŋiz	‘sea’	deniz
*kuul	‘hair’	kuul	*tuŋ	‘sharp obj’	tu: ‘needle’ <tığ>
*kit-	‘depart’	git-	*til	‘tongue’	dil
*kol	‘hand’	kol	*toq	‘satiated’	tok
*kœz	‘eye’	gœz	*tœn-	‘turn’	dœn-
*kuŋ	‘bird’	kuŋ	*tut-	‘hold’	tut-
*kyl-	‘laugh’	gyl-	*tyŋ-	‘fall’	dyŋ-

As noted by Vaux, under this “palatal” analysis of Proto-Turkic, it is hard to explain why only front vowels voice consonants, since there is no known phonetic principle relating the front-back contrast of vowels to the voicing contrast in consonants.

However, if we assume that the Proto-Turkic had a vowel system based on [ATR], the stop voicing can be viewed as the result of vowel-to-consonant spreading of [+ATR] followed by the reinterpretation of [+ATR] consonants as voiced ones. Vaux (1996, 2009) regards all voiced obstruents as (phonetically) [+ATR] because, in the production of voiced obstruents, the tongue root should be advanced to build up sub-glottal pressure sufficient to induce vocal fold vibration (see also Halle, Vaux, & Wolfe, 2000). The ATR-to-palatal shift which takes place later in modern Turkic languages obscures the original condition for this consonant voicing. See Vaux (2009) and references therein for more attested cases such as Armenian showing the interaction between consonantal and vocalic [ATR].

### 2.3.2.3.1. Chinese transcriptions

Hattori (1975) argues that Middle Mongolian<sup>79</sup> had a vowel harmony of “open-narrow” type (which can be reinterpreted as a tongue root-based harmony in current terms) based on a written source in Chinese scripts, *The Secret History of the Mongols* (*The Secret History of the Yuan Dynasty* 元朝秘史 *Yuáncháo mìshǐ*). In this source, the Mongolic vowel “/ü/” corresponds to Chinese [u], not [y]. Under a palatal analysis, this is rather surprising because “/ü/” is expected to correspond to [y] considering that the 14<sup>th</sup> century Pekingese had the distinction between [u] and [y].

(121) MM *ü* corresponds to Chinese *u* in *the Secret History of the Mongols* (Hattori, 1975, p. 16)

<i>gü</i> (or <i>kü</i> ) <sup>80</sup>	古[ku <sup>2</sup> ]	估[ku <sup>2</sup> ]	沽[ku <sup>1,2</sup> ]	誥[ku <sup>2,3</sup> ]
<i>kü</i>	枯[k‘u <sup>1</sup> ]	窟[k‘u <sup>2</sup> ]		

Hattori also shows Middle Mongolian-Chinese correspondences which suggest that MM “/ä/” and “/ö/” were central, not front, vowels. See Hattori (1975, p. 15) for relevant data. Based on these facts, he conjectures that Middle Mongolian vowel harmony was based on “open” vs. “close” contrast.

### 2.3.2.3.2. Korean transcriptions

Old Mongolian words are also found in Middle Korean texts. However, they have not drawn much attention from Mongolists: for example, Svantesson et al. (2005, p. 98)

---

<sup>79</sup> Although Hattori (1975) and K.-M. Lee (1964, 1972a) use the term *Middle Mongolian* (à la Poppe, 1955), I use the term *Old Mongolian* following Svantesson et al. (2005, p. 98).

<sup>80</sup> The data given here seem to be confined to those containing dorsal consonants (*g* or *k*). However, see Hattori (1973) for more examples like MM /tu, tü/ :: 圖[t‘u<sup>1</sup>] and MM /du, dü/ :: 突[t‘u<sup>2</sup>]. Interestingly, MM /šün/ with a palatal consonant corresponds to 盾[šyn<sup>2</sup>] ([t‘un<sup>3</sup>]) (Hattori, 1973, p. 38).

dismiss Mongolian words in Korean texts (and others written in languages such as Armenian and Georgian) as less important for the reconstruction of Old Mongolian. However, as we will see later in the next chapter, the Middle Korean vowel system is well-documented and thus the quality of each vowel is fairly uncontroversial.

(122) Middle Korean vowels proposed by K.-M. Lee (1972a, p. 137)

ㅣ i	ㅡ i	ㅓ u
	ㅚ ə	ㅜ o
	ㅓ a	· ʌ <sup>81</sup>

The following is representative examples from the 16<sup>th</sup> century Middle Korean texts such as *Penyek pak thongsa* 翻譯朴通事 (1517) and *Hwunmong cahoy* 訓蒙字會 (1527):

(123) Examples of Mongolian loanwords (K.-M. Lee, 1964)

Old Mongolian	Late Middle Korean	Gloss
a. <u>kü</u> reng	<u>ku</u> raŋ	‘dark brown’
b. <u>kö</u> gsin	<u>kw</u> əkcin	‘old wild falcon’
c. bay <u>ud</u> al	pa <u>ot</u> al	‘military camp’
d. <u>o</u> lang	<u>o</u> raŋ	‘belly-band, girth’

---

<sup>81</sup> The position of /ʌ/ has been controversial (see 0). However, it will not affect our discussion here because there is only one example of Mongolian loanword transcribed with this vowel (Written Mongolian *qudu*rya > Middle Korean 고들개 *ko*ṭal*kaj* ‘crupper’ and it was somehow ignored in the previous literature (see §3.5, however).

The correspondence between Old Mongolian and Middle Korean vowels, underscored in the above examples, is summarized in the table below:

(124) MK transcription of the 13<sup>th</sup> c. Mongolian vowels (K.-M. Lee, 1964, p. 195)

OM	i	e	a	ü	ö	u	o
MK	ㅣ	ㅓ	ㅑ	ㅓ	ㅕ	ㅗ	

Notably the MK transcription for the 13<sup>th</sup> ~ 14<sup>th</sup> century Mongolian loanwords shows that the OM vowels <ü, u, ö, o> all correspond to MK back vowels <ㅓ, ㅕ, ㅗ>. This can be understood relatively straightforwardly in the RTR analysis, but not in the palatal analysis, of Old Mongolian vowels.

Here is the comparison between the two alternative analyses:

(125) Correspondence between OM and MK vowels under the RTR analysis of OM

a. RTR analysis (my view)

OM		MK	
<i>	i	i	<ㅣ>
<e>	ə	ə	<ㅓ>
<a>	a	a	<ㅑ>
<ü>	u	u	<ㅓ>
<u>	ʊ	o	<ㅗ>
<ö>	o	wə	<ㅕ>
<o>	ɔ	o	<ㅗ>

b. Palatal analysis (conventional view)

OM		MK	
<i>	i	i	<ㅣ>
<e>	e	ə	<ㅓ>
<a>	a	a	<ㅑ>
<ü>	y	u	<ㅓ>
<u>	u	o	<ㅗ>
<ö>	ø	wə	<ㅕ>
<o>	o	o	<ㅗ>

(Shaded area indicates apparent mismatches.)

Due to the difference in the vowel inventory, especially the number of rounded vowels, between Mongolian and Korean, mismatches are inevitable in both cases. The number of apparent mismatches is 3 in the RTR analysis vs. 4 in the palatal analysis, which might not seem to be a difference big enough to favor one approach over the other. However, all the mismatches in the former analysis can be reasonably explained, while those in the latter seem to be tricky.

In the RTR analysis, the MK transcriptions of OM \*i, \*ə, \*a, \*u into /i, ə, a, u/ are all good. The transcription of both \*ʊ and \*ɔ with /o/ is also understandable: since /o/ is the only non-high rounded vowel in MK, it might have been used to denote the relative, phonetic height difference between non-RTR \*u and RTR \*ʊ as well as the phonological height difference between high \*u and low \*ɔ. Note that \*ʊ and \*ɔ share the RTRness<sup>82</sup>: non-RTR low rounded vowel \*o cannot be transcribed into the same /o/. Instead, it is transcribed into MK /wə/: /w/ maybe denotes the labiality of the original OM \*o, the labial counterpart of low unrounded vowel /ə/ that is missing in the MK inventory.<sup>83</sup>

On the contrary, the palatal analysis of OM raises some non-trivial questions. First, the MK transcription of OM \*e into /ə/ is unsatisfactory because it does not reflect the putative frontness of OM \*e. Compare this to the MK transcription of Middle Japanese \*e into <ㅐ> yey or <ㅑ> ye in *Ilopha* 伊路波(1492), a Korean version of the Japanese *Iroha* poem published by *Sayekwen* 司譯院, the Chosun Dynasty Interpreters' School (S.-H. Jeong, 2009; Unger, 2009, p. 79). Similarly, the

---

<sup>82</sup> Thus, their neutralization in MK transcriptions reminds us of the Dagur type height neutralization. Recall that Dagur type languages are viewed as having inherited the Old Mongolian contrastive hierarchy [coronal] > [labial] > [RTR] > [low]. The MK transcription of \*ʊ and \*ɔ with the same vowel /o/ may be reflective of the relative weakness of [low] contrast in Old Mongolian contrastive hierarchy.

<sup>83</sup> 0 presents an RTR analysis of Middle Korean which will make the correspondence between OM and MK even more convincing at the level of phonological features.

transcriptions of OM \*y to MK /u/ and of OM \*ø to MK /wø/ do not reflect the alleged frontness of OM vowels, either. More than anything else, the correspondence between OM \*u and MK /o/ does not make sense because MK has /u/ in the inventory. The prediction a palatal analysis of OM would make is that OM \*u would be transcribed as MK /u/, and OM \*y as something else. However, instead of OM \*u, OM \*y was transcribed as MK /u/ in MK documents.

To sum up, the Mongolian loans written in Korean scripts support the RTR analysis rather than the palatal analysis.<sup>84</sup>

---

<sup>84</sup> Ironically, however, the Mongolian loan data were used as primary evidence for a palatal analysis of Middle Korean by K.-M. Lee (1964, p. 196) who took the conventional palatal analysis of Old Mongolian for granted. The palatal analysis calls for an alleged vowel shift in Middle Korean. This issue will be discussed in detail in §3.5.



### 2.3.3. The development of the Mongolic vowel systems

The RTR analysis of Old Mongolian changes our understanding on the development of the Mongolic vowel systems as schematized below:

(126) The development of the Mongolic vowel systems

a. Type I: Khalkha type languages

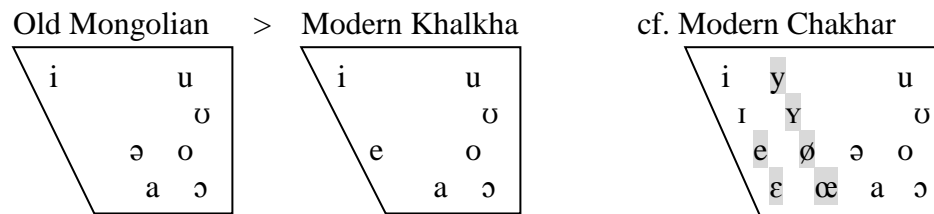

b. Type II: Monguor type languages (merger by RTR neutralization)

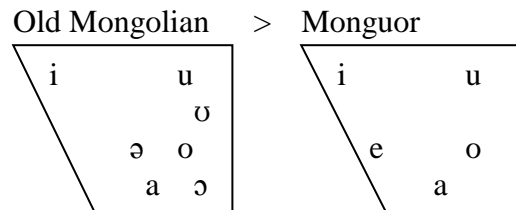

c. Type III: Dagur type languages (merger by height neutralization)

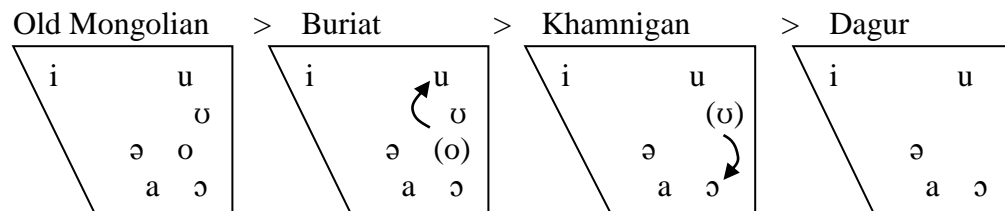

d. Type IV: Oirat type languages ([α RTR] → [α dorsal] (à la Vaux, 2009)).

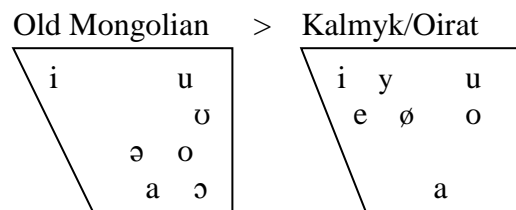

In the above scenario, first of all, the Khalkha type languages in (126)a retain the vowel quality of most Old Mongolian vowels intact, except for the fronting of \*ə to [e] in, e.g., Khalkha. Other Mongolian dialects such as Chakhar and Baarin, however, retain this vowel as [ə] as well. Note that the creation of new front vowels (/e, ε, y, γ, ø, œ/) through vowel umlaut and the putative split of \*i into /i/ and /i/ in Chakhar does not affect the original vowel qualities and harmony patterns. Compare this with Svantesson’s scenario (Svantesson, 1985, 1995, 2000, 2004; Svantesson et al., 2005), whereby the Khalkha vowel system is viewed as the product of palatal-to-RTR harmony shift via *pharyngealization* and *velarization*.

Second, the Monguor type languages in (126)b receives much more reasonable treatment in terms of merger by RTR neutralization between harmonic pairs (\*u, \*ʊ > u, \*o, \*ɔ > o) rather than merger by *velarization*. This analysis relates the Monguor type languages to other Altaic languages such as Manchu in §4.2.1 (Dresher & Zhang, 2005) and Middle Korean in §0 where we find the same type of merger patterns and the concomitant loss of vowel harmony. Recall that the Monguor type languages once shared the same contrastive hierarchy as the Khalkha type languages (§0), but later lost RTR contrast and harmony. Shira Yugur and Kangjia, the “synharmonic” varieties belonging to the Gansu-Qinghai Mongolic languages, can be viewed as the intermediate stage in the course of histrocial development from the Khalkha type to the Monguor type languages.

Third, the Dagur type languages in (126)c also receives simpler treatment. In Svantesson’s view, there must be three consecutive sound changes in Dagur, namely, *pharyngealization*, *velarization*, and *polarization*, which resulted in the merger of the rounded back vowels (\*u > ʊ > ɔ; \*o > ɔ) and the merger of the rounded front vowels (\*y > u; \*ø > o > u). Under my analysis, by contrast, Dagur has only experienced merger by *height neutralization* (\*u, \*o > u, \*ʊ, \*ɔ > ɔ). With respect to the

contrastive hierarchy, Dagur is conservative rather than innovative since it retains the Old Mongolian hierarchy [coronal] > [labial] > [RTR] > [low]. The basic mechanism of the merger is the same in both Monguor and Dagur type languages: the neutralization of the minimal contrast conveyed by the lowest ranked feature. The difference, however, comes from the different orderings: [RTR] is bottom-ranked in Monguor, whereas it is [low] in Dagur. Notice that, unlike Svantesson (Svantesson, 2000; Svantesson et al., 2005), I classify Khamnigan Mongol and Buriat into the Dagur type languages: they represent an intermediate stage in the direction of this sort.

Finally, the Kalmyk/Oirat type languages in (126)d are no longer considered to retain the Old Mongolian vowel system, but now analyzed to have undergone a RTR-to-palatal shift of the basis of vowel harmony. Note that this shift is not necessarily a result of chain shift which consists of the fronting of \*u and \*o to /y/ and /ø/ and the subsequent raising of \*o and \*ɔ to /u/ and /o/ (or vice versa). Rather, it may be a reinterpretation of the harmonic feature from [RTR] to [dorsal] ([α RTR] → [α dorsal], adapting Vaux's (2009) formalization), which presumably affected all rounded vowels simultaneously. The acoustic effect of this direction of shift can be understood as an enhancement of the F1 difference which is intrinsic to the original RTR contrast. It is notable in this sense that a relative height difference has been observed between /u/ and /y, i/ in Kalmyk: /u/ can be pronounced with a slightly lower tongue position (Bläsing, 2003, p. 230f.). Also, this RTR-to-palatal shift explains the existence of uvulars in the consonant inventory of Kalmyk and Oirat (Birtalan, 2003, p. 213f.; Bläsing, 2003, p. 231; Svantesson et al., 2005, p. 149).

(127) Velar vs. uvular distinction in Kalmyk (Svantesson et al., 2005, pp. 158–177)

a. velar /g/		b. uvular /g/			
ger	< *ker <sup>85</sup>	‘house’	gar	< *kar	‘hand’
k <sup>h</sup> yrgn	< *k <sup>h</sup> ureken	‘son-in-law’	xurgn	< *k <sup>h</sup> ʊrohʊn	‘finger’
yg	< *uke	‘word’	uga	< *ʊkija	‘to wash’

A thorough investigation of the comparative vocabulary provided in Svantesson et al. (2005, pp. 158–177) reveals that /g/ and /g/ in Kalmyk are almost in complementary distribution, although they are treated as distinct phonemes: the former appears in front-vowel words which corresponds to OM non-RTR words, whereas the latter appears in back-vowel words which corresponds to OM RTR words, the only exception being *bulg* < OM \**pʊlak* ‘spring.’ This suggests that the original system was RTR-based, if we follow Nevins’s generalization that velar-uvular alternation is conditioned by [ $\pm$ ATR(RTR)], [ $\pm$ high], or [ $\pm$ low], not by [ $\pm$ back] (Nevins, 2010, pp. 92–93).

It is noteworthy that Kögjiltü (1982 and subsequent works) regards the front rounded vowels /y, ø/ in Oirat as secondary under the Turkic influence.<sup>86</sup> It may not be just a coincidence that the residential areas of Oirats are populated largely by Turkic people, the Uyghurs and the Kazakhs (Indjieva, 2009, pp. 28–32). It is interesting that, to the best of my knowledge, Kazakh is the only language that has been claimed in the literature to have an RTR harmony system (Vajda, 1994). Also,

---

<sup>85</sup> The vowels in these OM forms reconstructed by Svantesson et al. are modified according to my RTR analysis.

<sup>86</sup> A similar Turkic influence on an RTR-based vowel system seems to be found in the case of “Yakut interference” in some Tungusic varieties spoken in the Yakut (Saxa) Autonomous Republic. Malchukov (2006, p. 123) briefly mentions that Ewenki has developed a front rounded [ü] as an allophone of /u/: e.g. *ümiin* < *umum* ‘one.’

Juwon Kim (p.c.) points out that several other Turkic languages such as Tuvan might also have a more RTR-like system rather than the typical palatal system.

Overall, the present analysis gives a simpler treatment to the vocalic history of the Mongolic languages than Svantesson's Mongolic Vowel Shifts, eliminating all the less-natural, less-attested changes, i.e., *pharyngealization*, *velarization*, and *polarization*, as well as the unattested intermediate stages, e.g., the second stage in (107)b ii and (107)c iii.

Within the contrastive hierarchy approach, the historical development of the Mongolic vowel systems can be schematized as in (128) below. Type III (Dagur) retained the Old Mongolian contrastive hierarchy [coronal] > [labial] > [RTR] > [low], but lost the lowest-ranked feature [low] in the end. All the other types (I, II, and IV) underwent a promotion of [low],<sup>87</sup> yielding the contrastive hierarchy [coronal] > [low] > [labial] > [RTR] as in Khalkha above. There was no further change in the contrastive hierarchy in Type I (Khalkha), whereas Type II (Monguor) and Type IV (Kalmyk/Oirat) underwent further changes. Type II further lost the lowest-ranked feature [RTR]. Type IV underwent the shift of the basis of vowel harmony from [RTR] to [dorsal].

---

<sup>87</sup> By assumption, this promotion of [low] takes place in a step-by-step mode: OM [coronal] > [labial] > **[RTR]** > [low] to [coronal] > [labial] > **[low]** > [RTR] to Khalkha [coronal] > **[low]** > [labial] > [RTR], although there seems to be no attested case of the intermediate hierarchy.

(128) Historical development of the Mongolic vowel systems:

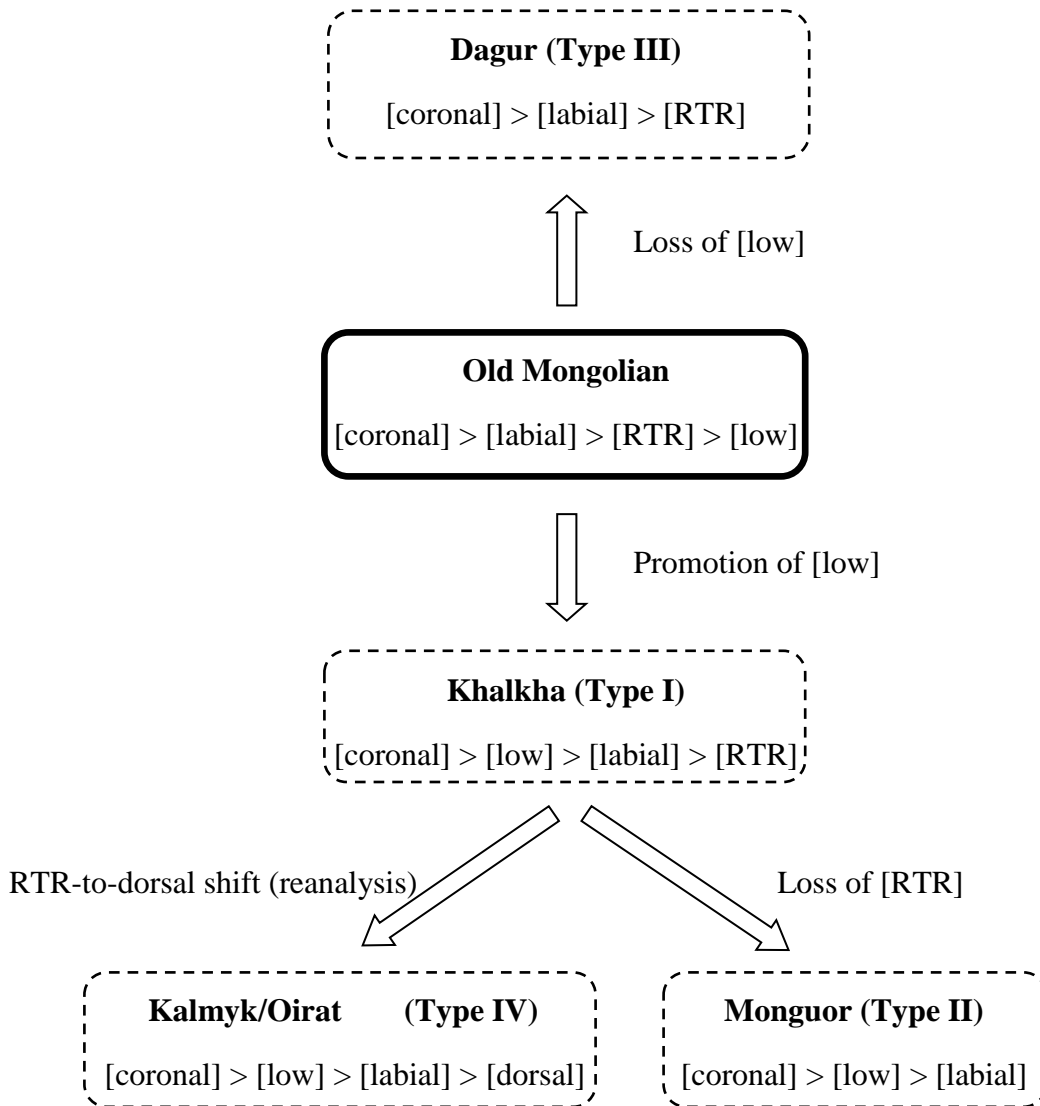

## 2.4. Implication on the intra-Mongolic taxonomy

The analysis of old and modern varieties of Mongolian proposed in this chapter has implications for the issue of the intra-Mongolic taxonomy. Using the vowel shift facts as the primary innovation in the classification as Svantesson (2000) did, we find that the historical paths distinguished in (128) are remarkably consistent with the most recent classifications by Rybatzki (2003b).

A tentative classification of the Mongolic languages based on the synchrony and diachrony of vowel systems investigated in this dissertation is as follows:

(129) A tentative classification of the Mongolic languages based on their vocalisms

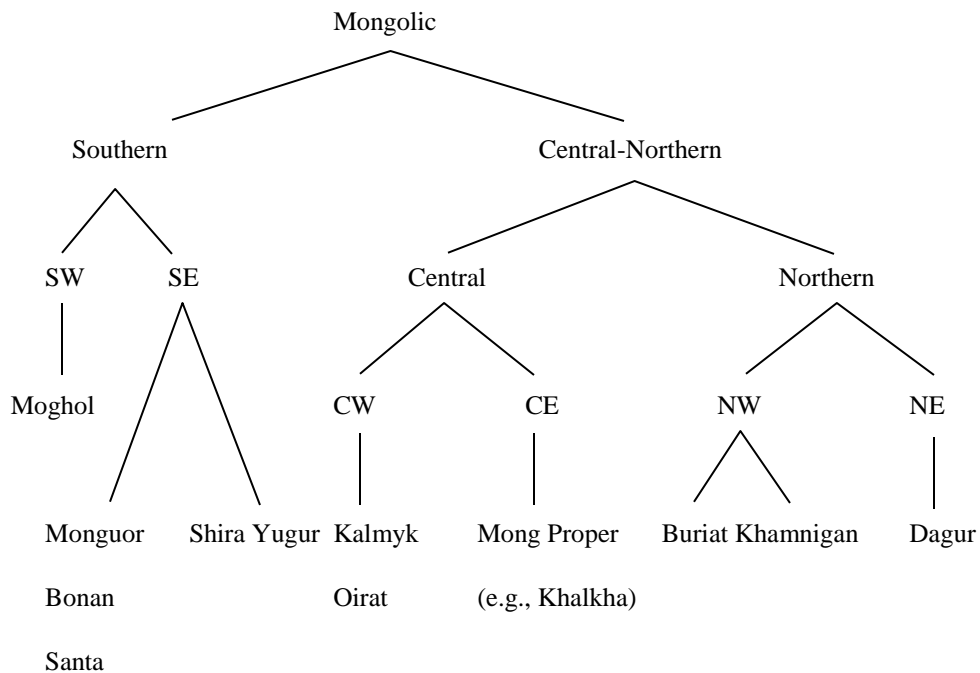

The Southeastern (SE) Mongolic can be further divided into (a) Shira Yugur (and Kangjia) and (b) Monguor/Bonan/Santa group since I viewed the former as a transitional group between Khalkha type languages and Monguor type languages for the reason that it retains RTR harmony.

Recall that Rybatzki, based on comparisons of a number of phonological, morphosyntactic, and lexical features, proposed the following classification:

(130) Rybatzki (2003b, pp. 388–389)	cf. (129)
a. Northeastern Mongolic (NE): Dagur	NE
b. Northern Mongolic (N): Khamnigan-Buriat	NW
c. Central Mongolic (C): Mongol proper-Ordos-Oirat	CE & CW
d. South-Central Mongolic (SC): Shira Yugur	SE (a)
e. Southeastern Mongolic (SE): Monguor-Bonan-Santa	SE (b)
f. Southwestern Mongolic (SW): Moghol	SW

The major difference, however, is that Kalmyk/Oirat is treated as a separate group in my classification, but not in Rybatzki's.



## CHAPTER THREE

### KOREAN

#### 3.1. Introduction

This chapter explores the synchrony and diachrony of the Korean vowel system and attempts a unified formal account for various issues in Korean historical phonology within the framework of the *contrastive hierarchy* (Dresher, 2009).

##### 3.1.1. *The Korean language*

###### 3.1.1.1. Periodization

The most-widely accepted periodization of Korean is as follows:

- (1) Periodization of Korean (K.-M. Lee, 1972a; K.-M. Lee & Ramsey, 2011)

Old Korean	Before 10 <sup>th</sup> century
Early Middle Korean	10 <sup>th</sup> -14 <sup>th</sup> centuries (918-1392)
Late Middle Korean	15 <sup>th</sup> -16 <sup>th</sup> centuries (1392-1592)
Early Modern Korean	17 <sup>th</sup> -19 <sup>th</sup> centuries
Contemporary Korean	20 <sup>th</sup> century

The explanation on the diachronic development of the Korean vowel system in this chapter will begin with the vowel system in Late Middle Korean and expand to Early Modern Korean and Contemporary Korean.

The first two periods, i.e., Old Korean and Early Middle Korean, are excluded from the contrastive hierarchy analysis because written records from these pre-alphabetic periods<sup>1</sup> provide only fragmentary, insufficient information on the vowel systems and patterns. However, Section 3.5 will provide a full discussion on the Old and Early Middle Korean vowel systems. Since we are not going to deal with the Early Middle Korean vowel system until then, and more crucially, I will argue that no distinction is necessary between Early and Late Middle Korean,<sup>2</sup> I will simply use the term Middle Korean to refer to K.-M. Lee's Late Middle Korean throughout the chapter, unless the distinction is required for the expository purposes.

### **3.1.1.2. Dialects**

Unlike the Mongolic (Chapter 2) and Tungusic languages (Chapter 4), “the Korean language is relatively homogeneous, with good mutual intelligibility among the speakers from different areas” (H. Sohn, 1999, p. 57). Therefore, we will deal with dialectal variations within the language rather than language variations within a group of languages.

In this chapter, I assume that the Korean language is divided into the following six regional dialects:

---

<sup>1</sup> The Korean alphabet *Hankul*, originally named *Hwunminchengum* (“the correct sounds for the instruction of the people”), was promulgated in 1446.

<sup>2</sup> The primary source of the demarcation between Early and Late Middle Korean is the Korean Vowel Shift hypothesized by K.-M. Lee (1964 et seq.). Later in §3.5, however, I will show that this hypothesis is untenable and, thus, that the distinction made between the two historical periods has no solid linguistic basis.

- (2) Modern dialects of Korean (cf. I. Lee & Ramsey, 2000, p. 311; H. Sohn, 1999, p. 57)
- a. Northwest Korean – the dialects of Pyengan Province
  - b. Northeast Korean – the dialects of Hamkyeng Province
  - c. Central Korean – the dialects of Seoul, Kyengki, Kangwen, Hwanghay, and Chwungcheng Province
  - d. Southwest Korean – the dialects of Cenla Province
  - e. Southeast Korean – the dialects of Kyengsang Province
  - f. Jeju (or Cheju) Korean – the dialects of Ceycwu Province (the island of Ceycwu)

### 3.1.2. *Structure of Chapter 3*

Chapter 3 is structured as follows. Section 0 to Section 3.4 provide a contrastive hierarchy analysis of the vowel system in Middle Korean, Early Modern Korean, and Contemporary Korean, respectively, and show that the historical development of the Korean vowel system can be best analyzed as a change from an RTR-based two-height system (MK) to a labial contrast-based three-height system (EModK). Then, Section 3.5 overviews the *Korean Great Vowel Shift* hypothesis (K.-M. Lee, 1972a; K.-M. Lee & Ramsey, 2011), a famous alternative explanation on the vocalic history of Korean, and argue, based mainly on the newly proposed RTR analysis of Old Mongolian vowel system presented in the previous chapter (§0), that there was no such a shift. Section 3.6 concludes the chapter.

### 3.2. Vowel contrast in Middle Korean

Middle Korean had seven monophthongs /i, ɨ, u, ə, o, a, ʌ/.<sup>3</sup> Traditionally, the vowel system has been viewed as a three-height system with high, mid, and low vowels. It is asymmetrical in the sense that there is only one front vowel and all the other six vowels are back vowel. One of the main characteristics of the Middle Korean vowel system is its vowel harmony, although there is still no consensus on its phonetic and phonological nature. It has been recognized that it is very difficult to derive the vowel harmony pattern from the conventional three-height vowel system. The vowel system and harmony will be the main issue in this section: in a nutshell, I propose a contrastivist analysis that Middle Korean vowel system is indeed a two-height system with RTR-based vowel harmony.

Another main characteristic of Middle Korean vowel system is that it had the vowel /ʌ/ (the so-called *alay a* “below /a/”) that underwent a complete loss in most Modern dialects. Jeju Korean retains its modern reflex /ɔ/, but there is no direct evidence that it retains as well the phonetic quality of /ʌ/. It is well-known that /ʌ/ disappeared in two stages in the history of Korean language: first, /ʌ/ merged with /i/ in Middle Korean mainly in non-word-initial position, and later, merged with /a/ in Early Modern Korean. Interestingly, its modern reflex in Jeju Korean, /ɔ/, is now merging with /o/. Although it is believed that the loss of /ʌ/ is one of the main causes of the collapse of Middle Korean vowel harmony, no formal analysis has been given as to how these different merger patterns emerge. I address this issue in section 3 and 4 when I deal with Early Modern Korean and Modern Jeju Korean.

---

<sup>3</sup> Diphthongs will not be considered in this thesis, although they compose an important part of the vowel system. See Ahn & Iverson (2007) for an analysis of the historical development of Korean diphthongs.

### 3.2.1. Vowel system and vowel harmony in Middle Korean

#### 3.2.1.1. Vowel system in Middle Korean

Let us begin with the vowel system of Late Middle Korean (henceforth Middle Korean, MK) given in (3).

(3) (Late) Middle Korean vowels as proposed by K.-M. Lee (1972a, p. 137)

	i	—	ĩ	⊥	u
			‡	⊥	o
			‡	·	Λ

Middle Korean had seven vowels, /i, ĩ, u, ə, o, a, Λ/, which are juxtaposed with their *Hankul* equivalents in (3) for expository purposes.

Note that the vowel chart in (3), although relevant distinctive features are not explicitly given, reflects an implicit phonological analysis. For example, the positioning of the vowel /Λ/ as a low vowel seems to be due to “a systematic consideration of filling a gap” in the system (J.-K. Kim, 2000, p. 180) rather than a pure phonetic estimation. As far as the phonetic quality of vowels is concerned, however, /Λ/ has been phonetically described as a sound falling in between /a/ and /o/ (K.-M. Lee, 1972a, p. 137; S. N. Lee, 1940) and positioned in the vowel chart as a mid vowel (J. Kim, 1993, p. 81) as shown in (4) below.

(4) Middle Korean vowels proposed by J. Kim (1993, p. 81)<sup>4</sup>

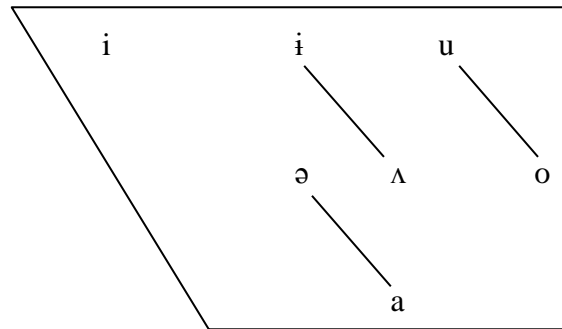

As pointed out by J. Kim (1993, p. 81), the vowel chart in (4) is consistent with the fact that /ʌ/ has changed into /i/, /a/, /o/, and sporadically /ə/. It is also consistent with the fact that its modern reflex in Jeju Korean is phonetically realized as a low back vowel /ɔ/. The position assumed for /ʌ/ here is reasonably close to all other vowel positions it has changed into (see also J.-K. Kim, 2000; W.-J. Kim, 1963; S.-J. Lee, 1977; Paek, 1988).

Both (3) and (4) reflect a generally accepted view that Middle Korean vowel system had a three-way height distinction: high, mid, and low vowels. However, this view is not suitable to capture the phonological nature of Middle Korean vowel harmony.<sup>5</sup>

### 3.2.1.2. Vowel harmony in Middle Korean

Middle Korean vowels can be arrayed into three harmonic sets based on their harmony pattern. The first set is made up of three RTR vowels /ʌ, o, a/, traditionally called “light,” “masculine,” or “positive (*yáng* 陽)” vowels. The second set is a set of three

<sup>4</sup> The diagonal lines indicate the harmonic pairs.

<sup>5</sup> Only a few scholars (J. Kim, 1999; J.-K. Kim, 2000; J.-H. Park & Kwon, 2009) claimed (whether explicitly or not) that the Middle Korean vowel system had a two-way height distinction in its “phonological” system.

non-RTR vowels /i, u, ə/, traditionally called “dark,” “feminine,” or “negative (*yīn* 陰)” vowels. The third set consists of a neutral vowel /i/, which is phonetically a non-RTR vowel as well. These three sets of vowels were also described as *selchwuk* 舌縮 ‘tongue retraction,’ *selseochwuk* 舌小縮 ‘slight tongue retraction,’ and *selpwulchwuk* 舌不縮 ‘no tongue retraction’ vowels, respectively, in *Hwunminjengum* (1446).

(5) Three harmonic sets in Middle Korean

Harmonic set	Vowel(s)	Description in <i>Hwunminjengum</i>
a. RTR vowels:	/ʌ, o, a/	<i>selchwuk</i> ‘tongue retraction’
b. non-RTR vowels:	/i, u, ə/	<i>selseochwuk</i> ‘slight tongue retraction’
c. a neutral vowel:	/i/	<i>selpwulchwuk</i> ‘no tongue retraction’

I assume, following J. Kim (1988a, 1989, 1993, 2001)<sup>6</sup> and J.-K. Kim (2000) among others, that the MK vowel harmony is based on the contrast in tongue root position, more specifically, the feature [RTR].

The basic vowel harmony pattern is illustrated in the following examples: all vowels in a stem were normally either RTR or non-RTR.<sup>7</sup>

(6) Stem-internal vowel harmony

a. Stems with RTR vowels only

/salʌm/ ‘person’, /barʌl/ ‘sea’, /kʌlʌm/ ‘river’, /nalʌh/ ‘nation’, /tasʌs/ ‘five’,

<sup>6</sup> J. Kim (1988a) interpreted *selchwuk* 舌縮 ‘tongue retraction’ in *Hwunminjengum* as *selkunhwuchwuk* 舌根後縮 ‘tongue root retraction’ (first proposed for Mongolian by Cenggeltei) and equated it with the feature [Retracted Tongue Root] in Western linguistics. He extended this “RTR” analysis to Tungusic languages such as Manchu, Ewen, Nanai (J. Kim, 1988b, 1989).

<sup>7</sup> The vowel harmony data presented in this chapter were mostly taken from J.-K. Kim (2000, p. 191ff.), I. Lee & Ramsey (2000, p. 287ff.), and J.-M. Song (1999, p. 138ff.), and rearranged by the author with necessary modifications.

/tɔcʌk/ ‘thief’, /talʌ-/ ‘different’, /pʌla-/ ‘look at’, /kʌpʰ-/ ‘repay’

b. Stems with non-RTR vowels only

/jəlɪm/ ‘fruit’, /njəlɪm/ ‘summer’, /kulək/ ‘mesh bag’, /tɪlɪh/ ‘field’,

/həmɪl/ ‘drawback’, /ətɪp-/ ‘dark’, /nuli-/ ‘yellow’, /pɪli-/ ‘call’

Vowel harmony also applied across morphological boundaries: affix vowels harmonized with stem vowels. Thus, in many cases, affixes have two allomorphs, an RTR and a non-RTR variant.<sup>8</sup> The choice between the two is determined by the stem vowel(s): e.g., an RTR stem takes an RTR suffix, whereas a non-RTR stem takes a non-RTR. This allomorphic alternation conditioned by vowel harmony is illustrated in the following examples which indicate that /u/~o/, /i~/ɪ/, and /ə~/a/, respectively, form a harmonic pair.

(7) Vowel harmony across morphological boundaries

a. verb/adjective stem + conjunctive suffix ‘-a/-ə’

RTR vowel stem		non-RTR vowel stem	
/mak-a/	‘block’	/mək-ə/	‘eat’
/kot-a/	‘straight’	/kut-ə/	‘solid’
/sʌl-a/	‘burn’	/sɪl-ə/	‘disappear’

b. verb/adjective stem + adnominal suffix ‘-on/-un’

RTR vowel stem	non-RTR vowel stem
----------------	--------------------

---

<sup>8</sup> There also exist non-harmonic affixes which have an invariant shape: consonant-initial suffixes do not behave as the target of the [RTR] spreading from the stem. This fact is somewhat surprising because in many languages the spreading of the harmonic feature is in a vowel-to-vowel manner and is not blocked by an intervening consonant. J.-K. Kim (2000) assumes these consonant-initial suffixes to be pre-specified with [±RTR] value so that it may not be affected by the spreading of the [RTR] value from the stem vowel and, by contrast, those harmonic suffixes introduced in (7) to be unspecified with respect to the harmonic feature so that the [RTR] value of the stem vowel can spread onto the suffix.



/mak-on/ ‘block’	/mæk-un/ ‘eat’
/kot-on/ ‘straight’	/kut-un/ ‘solid’
/sʌl-on/ ‘burn’	/sɪl-un/ ‘disappear’

c. noun + particle (accusative particle ‘-ʌl/-il’ or locative particle ‘-aj/-əj’)

RTR vowel stem	non-RTR vowel stem
/salʌm-ʌl/ ‘person’	/jəlɪm-il/ ‘fruit’
/tocʌk-ʌl/ ‘thief’	/kulək-il/ ‘mesh bag’
/palʌl-aj/ ‘sea’	/njəlɪm-əj/ ‘summer’
/nalah-aj/ ‘nation’	/tɪlɪh-əj/ ‘field’

The vowel /i/ is neutral, in the sense that it can co-occur with either RTR vowels or non-RTR vowels in a stem.

(8) The neutral vowel /i/ can co-occur either RTR vowels or non-RTR vowels.

a. /i/ with RTR vowels

/tali/ ‘leg’	/ipati/ ‘party’	/tʌli/ ‘bridge’
/kɪlʌma/ ‘packsaddle’	/pɪlok/ ‘even though’	/motil-/ ‘cruel’
/mocimala/ ‘reluctantly’		

b. /i/ with non-RTR vowels

/məli/ ‘head’	/tulumi/ ‘crane’	/nupi/ ‘quilt’
/kɪlɪməj/ ‘shadow’	/nɪlkup/ ‘seven’	/nɪmkɪm/ ‘king’
/mɪcɪkəj/ ‘rainbow’	/kəlɪcʰi-/ ‘salvage’	

Notice that the transparency of /i/ is manifested in examples like *mocimala*

‘reluctantly’ and *micikəj* ‘rainbow’ given above. The neutrality and transparency of /i/

suggests that its [RTR] feature value should be underspecified in the underlying representation.

Then, what if a stem consists of only neutral vowel(s)? We might expect that the “neutral-vowel-only” stems with no underlying specification for [RTR] would take non-RTR suffixes as a default option, since [-RTR] is the unmarked value under the RTR analysis. Interestingly, some neutral stems containing only the neutral vowel /i/ may take RTR or non-RTR suffixes, depending on the stem as shown below:

(9) “Neutral-vowel-only” stems (J.-K. Kim, 2000, p. 193)

a. RTR stems

/nic-ʌni/	‘forget’	/kit <sup>h</sup> i-om/	‘leave’
/cih-ʌni/	‘name’	/pskini-nʌn/	‘meal’

b. Non-RTR stems

/kilh-əj/	‘road’	/kip <sup>h</sup> -in/	‘deep’
/nil-isi/	‘rise’	/pisk-in/	‘tilted’

These examples are considered to suggest that the harmonic value of certain stems is lexically encoded, arguably as a floating feature (J.-K. Kim, 2000, p. 194).

J.-H. Park (1994, p. 150) also presents a list of “neutral-vowel-only” stems which inconsistently select either an RTR or a non-RTR suffix as shown below:

(10) Neutral stem: either RTR or non-RTR vowel suffix is attested. (J.-H. Park, 1994, p. 150)

RTR vowel-initial suffix

non-RTR vowel-initial suffix

<i>isy-a</i> <sup>9</sup>	/isja/	<WC 135> <sup>10</sup>	<i>isy-e</i>	/isjə/	<WC 135>
<i>cih-oni</i>	/cihʌni/	<SS 19:32>	<i>cih-uni</i>	/cihini/	<SS 11:24>
<i>pih-omye</i>	/pihʌmjə/	<WS 2:39>	<i>pih-umye</i>	/pihimjə/	<WS 10>
<i>kilh-ol</i>	/kilhʌl/	<WS 10>	<i>kilh-ul</i>	/kilhil/	<SS 6:19>
<i>him-ol</i>	/himʌl/	<WC 39>	<i>him-ul</i>	/himil/	<WS 10>
<i>ciz-a</i>	/ciza/	<WC 76>	<i>ciz-e</i>	/cize/	<WC 98>

From a diachronic point of view, this might be viewed as evidence for the distinction between the reconstructed non-RTR vowel \*/i/ and its RTR counterpart /i/ at an earlier stage (J.-H. Park, 1994).

### 3.2.1.3. A three-height analysis induces the “too many features” problem

The apparent three-way height distinction in (4) (and (3) as well) will logically require two height features, [high] and [low]. In addition, [coronal], [labial], and [RTR]

<sup>9</sup> I use italicized Yale Romanization for written forms attested in Middle Korean texts. Note that ㅛ /o/ and ㅜ /ʌ/ are transliterated as *wo* and *o*, respectively, to distinguish each other.

<sup>10</sup> The abbreviations for the Middle Korean texts cited in this chapter are as follows:

Abbr	Date	Title	Author and notes
YP	1445	Yongpi echen ka	Kwen Cey, Ceng Inci, An Ci; notes by Seng Sammun, Pak Pangnyen, Yi Kay
SS	1447	Sekpo sangcel	Swuyang (> Seyco)
WC	1449	Wel.in chenkang ci kok	Seycong
WS	1459	Wel.in sekpo	Seyco
NE	1462	Nungem kyeng enhay	Seyco; Translation of Śūraṅgama Sūtra
PH	1463	Pep-hwa kyeng enhay	Yun Salo, Hwang Swusin, et al.; Translation of Saddharma Puṇḍarīka Sūtra
KP	1466	Kwukup-pang enhay	
TS	1481	Twusi enhay [cho-kan]	Co Wi, Uy Chim; Translation of poems of Dù Fū
KS	1482	Kumkang kyeng samka-hay	Han Kyehuy, No Sacin
KK	1489	Kwukup kan.i-pang	
PS	1518	Pen.yek Sohak	Kim Cen, Choy Swuksayng

(Based on Martin (1992, p. 397). The dates may be cited differently by other scholars.)

features are used in order to distinguish front/back, rounded/unrounded, and RTR/non-RTR vowels, respectively. With these five features, the full feature specifications will be as follows:

(11) Full feature specifications with 3-way height distinction for MK vowels

	/i/	/ə/	/a/	/i̠/	/ʌ/	/u/	/o/
[coronal]	+	-	-	-	-	-	-
[high]	+	-	-	+	-	+	-
[low]	-	-	+	-	-	-	-
[labial]	-	-	-	-	-	+	+
[RTR]	-	-	+	-	+	-	+

In the above matrix, high vowels /i, i̠, u/ are specified [+high, -low], three mid vowels /ə, ʌ, o/ are specified [-high, -low], the only low vowel /a/ is specified [-high, +low].

If we view vowel harmony as spreading of a single harmonic feature, however, the above feature specifications are unsatisfactory in capturing the contrast between the two vowels in each harmonic pair, /ə/ and /a/, /i̠/ and /ʌ/, and /u/ and /o/ because there are more differences than necessary.

(12) Overspecifications for Middle Korean vowels

Non-RTR vowels	RTR vowels
/i̠/ [-cor, <u>+high</u> , -low, -lab, <u>-RTR</u> ]	/ʌ/ [-cor, <u>-high</u> , -low, -lab, <u>+RTR</u> ]
/u/ [-cor, <u>+high</u> , -low, +lab, <u>-RTR</u> ]	/o/ [-cor, <u>-high</u> , -low, +lab, <u>+RTR</u> ]
/ə/ [-cor, -high, <u>-low</u> , -lab, <u>-RTR</u> ]	/a/ [-cor, -high, <u>+low</u> , -lab, <u>+RTR</u> ]

Rather, the feature specifications make a wrong prediction that the ideal RTR harmonic counterpart to /ʌ/ would be /ə/, not /i/, because /ʌ/ and /ə/ have the same values for all the features other than [RTR]. This can be ascribed to “the problem of too many features” (Dresher, 2009; D. C. Hall, 2007), specifically too many “height” features. There is indeed, no positive evidence that both the two height features play a role in the MK phonology.

Another undesirable consequence of the three-way height distinction is that the feature specifications in (11) do not properly reflect the fact that the vowel /i/ (and its RTR counterpart /ʌ/ as well) is the most unmarked in the Korean phonology. The vowel /i/ emerges as the representative epenthetic vowel in phonologically conditioned allomorphy and loanword phonology and submerges as the deleted vowel in vowel hiatus. Rather, given the feature specifications in (11), the vowel /ə/, not /i/, would be taken for the most unmarked one with the feature specifications [-cor, -high, -low, -lab, -RTR].

It should also be pointed out that if we posit three phonologically-distinguished heights based on the vowel system in (3), a logically equivalent thing to do would be to posit three classes of vowels on the front-back dimension, i.e., front, central, and back vowels, which surely will exacerbate “the problem of too many features.”

There is another problem with full specifications, which is independent of the problem of the three-way height distinction: regardless of how many height features are employed, a full specification analysis of /i/ in (11) is unable to explain why it co-occurs with both RTR and non-RTR vowels despite its prespecified [-RTR] value.

To overcome the above problems commonly attributable to overspecification, we need a procedure to identify which features are contrastive and which are redundant in a given system. A contrastive hierarchy analysis will provide such a procedure.



a. SDA: [coronal] > [low] > [labial] > [RTR]

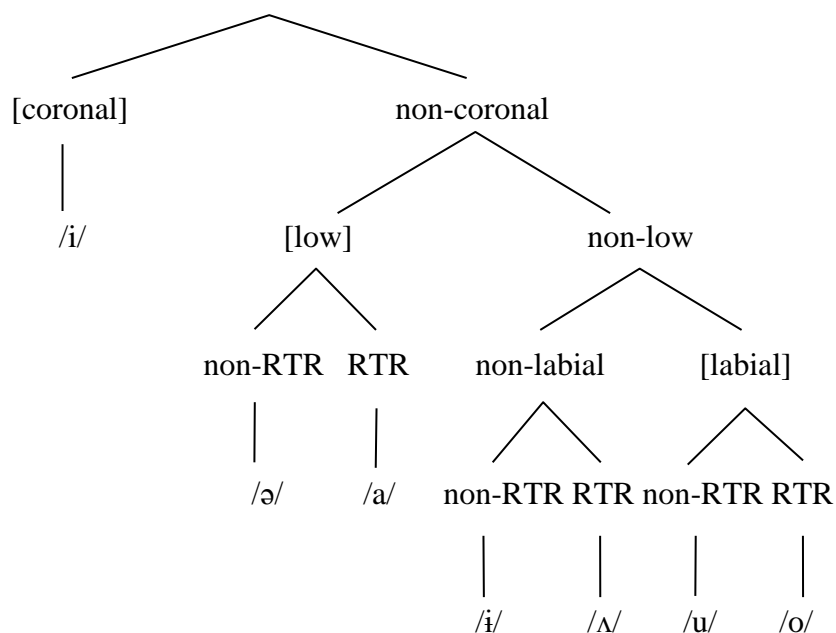

b. Output specifications

- /i/ = [+cor]    /i/ = [-cor, -low, -lab, -RTR]    /u/ = [-cor, -low, +lab, -RTR]  
 /ʌ/ = [-cor, -low, -lab, +RTR]    /o/ = [-cor, -low, +lab, +RTR]  
 /ə/ = [-cor, +low, -RTR]  
 /a/ = [-cor, +low, +RTR]

Four contrastive vowel features are adopted here to distinguish the seven Middle Korean vowels: a height feature [low], two place features [coronal] and [labial], and a tongue root feature [RTR]. With a single height feature [low], vowels are grouped into either low or non-low vowel. Thus, there is no “mid” vowel: /ʌ/, /o/, and /ə/, which have been traditionally viewed as a mid vowel, are treated now as either a non-low vowel (/ʌ/ and /o/) or a low vowel (/ə/). Thus, it is the phonetic implementation that is responsible for the realization of /ʌ, o, ə/ as mid vowels. This will be discussed in detail shortly.

According to the contrastive hierarchy proposed here, Middle Korean vowels are first divided by the feature [coronal] into /i/ vs. all the other vowels. No further specification including [RTR] specification is necessary for /i/ since it is already distinguished from all other vowels. Therefore, the [-RTR] specification is redundant for /i/. This explains the phonological behavior of /i/ as a neutral/transparent vowel with respect to RTR harmony.

The contrastive status of [coronal] is evidenced by the consonant palatalization in (15) and the vowel umlaut in (16).

(15) Three types of consonant palatalization (taken from J. Kim, 2000)

a. /t/-palatalization:  $t > c$ ,  $t^h > c^h$

/t̥ip<sup>h</sup>/ > /c̥ip<sup>h</sup>/ ‘straw’                      /t̥inita/ > /c̥inita/ ‘carry; hold’

b. /k/-palatalization:  $k > c$ ,  $k^h > c^h$

/kil/ > /cil/ ‘road’                              /k<sup>h</sup>i/ > /c<sup>h</sup>i/ ‘height’

/kilta/ > /cilta/ ‘long’

b’. Hypercorrection:

/c̥ic<sup>h</sup>/ > /k̥is/ ‘feather’                      /c̥ilsam/ > /k̥ils’am/ ‘weaving by hand’

/k̥juhwa/ > (by /k/-palatalization) /c̥juhwa/

> (by hypercorrection) /t̥juhwa/ ‘sunflower’

c. /h/-palatalization:  $h > s$

/h̥jəŋ/ > /s̥əŋ/ ‘older brother’                      /h̥im/ > /s̥im/ ‘strength’

Among the attested three types of palatalization in (15),<sup>12</sup> /k/-palatalization and /h/-palatalization, both of which are changes from a dorsal to a coronal,<sup>13</sup> are clear

<sup>12</sup> The /t/-palatalization involving a change from a coronal consonant /t/ to a coronal consonant /c/



examples of coronalization. Evidence shows that these palatalization processes took place as early as in the sixteenth century (J. Kim, 2000).

(16) Vowel umlaut (also known as /i/-regressive assimilation)<sup>14</sup>

<i>cyepi</i>	>	<i>cyeypi</i>	‘swallow’
<i>eyespi</i>	>	<i>eyeyspi</i>	‘pitifully’
<i>kyecip</i>	>	<i>kyeycip</i>	‘woman’
<i>kulyeki</i>	>	<i>kuulyeki</i>	‘wild goose’

Vowel umlaut is an assimilatory phenomenon whereby an off-glide diphthong is created by the influence of the following /i/ or /j/. This too can be traced back to the fifteenth century (J. Kim, 2000).

Another piece of evidence for [coronal] comes from a phonotactic restriction which bans the successive occurrences of [coronal] in diphthongal configurations, that is, \*/ji/ and \*/ij/ (Ahn & Iverson, 2007, p. 279). See also Clements & Hume (1995, p. 279) for similar OCP-driven constraints, i.e., \*/tj/, \*/sj/, \*/cj/, \*/ji/.

(17) Diphthongs formed with palatal /j/ (cf. Ahn & Iverson, 2007, p. 277ff.)

a. Monophthongs	b. On-glide diphthongs	c. Off-glide diphthongs
i      i      u	*ji    *jɨ    ju	*ij    ij    uj

---

might not be viewed as an example of coronalization in a strict sense. However, see Calabrese (2005) for an analysis of affrication as the outcome of “coronalization” followed by “fission” as a repair strategy.

<sup>13</sup> I assume that the phonetic value of /h/ before /i/ was palatal fricative ([ç]) as is now in Contemporary Korean (H. B. Lee, 1999, p. 122). Thus, /h/-palatalization can be phonetically described as [ç] > [s] (or [ɕ]). According to Hall (1997, p. 10ff.), palatal fricatives are dorsal, not coronal, whereas palatal noncontinuant and glides are coronal.

<sup>14</sup> See J.-S. Choi (1978) and J. Kim (2000) for more examples and references.

ə	o	jə	jo	əj	oj
a	ʌ	ja	jʌ	aj	ʌj

The second dichotomy is made between low vowels /ə, a/ and non-low vowels /i, ʌ, u, o/ by means of the feature [low]. Logically, at least three more contrastive features are required to distinguish the remaining six phonemes after applying [coronal]. Two of them are [labial] and [RTR], as we will see shortly. However, there seems to be no direct evidence for the contrastive status of [low] (or any other possible candidate) in phonological processes or phonotactic constraints. (This would not be a problem since a feature does not have to be active in the phonology in order to be contrastive.) If a feature must be selected at any rate, the best candidate would be a height feature which accounts for the (at least) three-way height distinction in phonetic implementation. One of the well-known vocalic universals of human languages related to vowel systems is that all languages have height distinctions (Trubetzkoy, 1969). This is confirmed by a typological survey of 209 languages balanced areally and genetically (Crothers, 1978). There may be multiple ways to encode height distinctions in phonology. For example, tongue root features such as [ATR] and [RTR] can be used to encode relative height differences between vowels. If the size of vowel inventory is relatively small, it might be possible to express the whole vowel height distinction using a tongue root feature rather than a height feature. This is the case of Dagur, a Mongolic language, which was analyzed as having the contrastive hierarchy [coronal] > [labial] > [RTR] in §2.2.3.1. In the case of Middle Korean, however, [RTR] can only express the relative height distinction between the harmonic pairs, but not the distinction between /ə, a/ and /i, ʌ, u, o/. Thus, a height feature is necessary.

Between the two logically-equivalent choices, i.e., [low] and [high], I opt for [low]. There are two reasons: first, calling /ʌ/ and /o/ “high vowels” seems odd when their

phonetic qualities are considered and, second, with this choice we can treat the “epenthetic” vowel /i/ as the most unmarked, i.e., non-coronal, non-low, non-labial, and non-RTR. If we choose [high], then /ə/ would take the maximally unmarked position instead.

It should be noted that there is no crucial evidence for the ordering between [coronal] and [low]: the reverse ordering [low] > [coronal] would also work for Middle Korean. The reason I have opted for the ordering [coronal] > [low] is that [coronal] seems to be more stable than [low]. Unlike the front-back contrast which has retained throughout the history, the height contrast has suffered from fluctuation, from a two-height contrast in Middle Korean to a three-height contrast in Early Modern Korean to a two-height contrast in e.g., modern Southeastern Korean.

The non-coronal non-low vowels, /i, ʌ, u, o/, are divided into rounded (/u, o/) and unrounded vowels (/i, ʌ/) by the third feature [labial]. The contrastive status of [labial] is evidenced by the following phonological change, whereby /i/ and /ʌ/ changed into /u/ and /o/, respectively, under the influence of the labial consonant /β/.<sup>15</sup>

(18) Loss of /β/ (뽕 W) through labialization (J.-P. Kim, 2003, p. 10f.)

a. β + ʌ > o

뚝외야	<i>toWoyya</i>	/tʌ.βʌj.ja/	>	뚝외야	<i>towoyya</i>	/tʌ.oj.ja/
가뽕뚝	<i>kaWontoy</i>	/ka.βʌn.tʌj/	>	가온뚝	<i>kawontoy</i>	/ka.on.tʌj/
호뽕사	<i>hoWoza</i>	/hʌ.βʌ.za/	>	호오사	<i>howoza</i>	/hʌ.o.za/

b. β + i > u

이뽕어든	<i>iWulGetun</i>	/i.βil.ə.tin/	>	이울어든	<i>iwulGetun</i>	/i.ul.ə.tin/
------	------------------	---------------	---	------	------------------	--------------

<sup>15</sup> This change may be better understood as a two-step process: /βV/ > /wV/ > /o, u/ as suggested in the representation by Yale Romanization (John Whitman, p.c.). See also K.-M. Lee & Ramsey (2011, pp. 136–139).

Evidence also comes from the optional alternation between /i, ʌ/ and /u, o/ before or after a labial consonant attested in the 15<sup>th</sup> and 16<sup>th</sup> century texts.

(19) Optional alternation between /i, ʌ/ and /u, o/

- a. Progressive labialization (S.-C. Jeong, 1995; J.-P. Kim, 2001, 2003; Nam, 1974; K.-K. Oh, 1993)

부르- *pulu-* /p*ʌ*li-/ <SS 9:0> ~ 부르- *pwulu-* /puli-/ <WS 9:38> ‘胞’

불- *pul-* /p*ʌ*l-/ <KK 2:74> ~ 불- *pwul-* /pul-/ <KK 2:2> ‘吹’

나뵈 *napoy* /nap*ʌ*j/ <NE 7:83> ~ 나뵈 *napwoy* /napoj/ <TS 15:32>

즈믄 *como* /c*ʌ*m*ʌ*/ <TS 7:6> ~ 즈모 *comwo* /c*ʌ*mo/ <NE 1:22>

다풀다풀 *tapholtaphol* /tap*ʰ**ʌ*ltap*ʰ**ʌ*/ <PH 6:137>

~ 다풀다풀 *taphwoltaphwol* /tap*ʰ**o*ltap*ʰ**o*/ <PH 7:9>

- b. Regressive labialization (Paek, 1992, p. 197)

님금 *nimkum* /nimk*ʌ*m/ <PS 9:44a> ~ 님금 *nimkwum* /nimkum/ <PS 9:38a>

말숨 *malsom* /mals*ʌ*m/ <PS 9:4b> ~ 말숨 *malswom* /malsom/ <PS 9:11b>

The above data show that the labial contrast is found nowhere but between /i, ʌ/ and /u, o/. Front vowel(s) and low vowels do not have this contrast. This gives us a strong clue as to the relative scope among [coronal], [low], and [labial]. That is to say, [labial] is dominated by the other two features: [coronal] > [labial] and [low] > [labial].

Labialization operates within a domain defined by the feature [coronal] and [low]. If we wrongly assume that [labial] takes scope over [low], the labial vowels /u/ and /o/ would require no further specification for [low]: with no way to confine the labialization to non-low vowels, we would predict that /ə, a/ can also possibly be labialized to /u, o/, which is unattested in Middle Korean texts. It is also noteworthy to

mention that the established relative order between [coronal] and [labial], i.e., [coronal] > [labial], is consistent with Ghini's (2001) generalization regarding [labial] specification:

(20) Constraint on [labial] (Ghini, 2001, p. 152):

Vowels can be specified for [Labial] iff another place of articulation feature is already available.

In addition, the phonotactic constraint against a homorganic labial CV sequence (\*pw, \*p<sup>h</sup>w, \*mw) (Clements & Hume, 1995) also supports the contrastive status of [labial].

The last cut is made by the feature [RTR]. Obviously, the evidence for the contrastive status of [RTR] comes from the RTR vowel harmony we have seen earlier. Korean vowel harmony, traditionally considered to be based upon the opposition between “light” vs. “dark” vowels (Huh, 1980; Kim-Renaud, 1976) and often called “diagonal” harmony (Hayata, 1975) has been analyzed in various ways with no overt consensus reached yet. Ignoring intra-group differences, the previous proposals made so far can be classified roughly into four groups as follows:

(21) Previous analyses of Korean vowel harmony<sup>16</sup>

- a. “Selchwuk” harmony: Huh (1965), W.-J. Kim (1978), C.-G. Kim (1984, 1985, 1995), C. Park (1986)
- b. Height harmony: S.-N. Lee (1949), P.-H. Kim (1964), Y.-S. Moon (1974), Y. S. Kim (1977), McCarthy (1983), S.-C. Ahn (1985), H.-S. Sohn (1987), S. Park (1990)

---

<sup>16</sup> Some of these proposals are made for modern Korean vowel harmony.

- c. Palatal harmony: W.-J. Kim (1963), K.-M. Lee (1972a), C.-W. Kim (1978), Ji (1976, as cited in Song 1999), K.-K. Lee (1985)
- d. Tongue root harmony: J.-H. Park (1983), B.-G. Lee (1985), J. Kim (1988a, 1993, 1999), Y.-S. Kim (1988, with the feature [Deep Voice Resonance], the acoustic equivalent to [RTR]), J.-S. Lee (1992), Y. Lee (1993), M.-H. Cho (1994), D.-Y. Lee (1994), J.-K. Kim (2000), Park & Kwon (2009)

Among these, I follow the tongue root harmony approach since it is well-grounded, well-documented, and, more than anything else, consistent with the known facts about the vowel system and vowel harmony in Middle Korean. See J.-H. Park (1983), J. Kim (1988a, 1993, 1999), J.-K. Kim (2000), and Park & Kwon (2009) among others for relevant argumentations in favor of the tongue root harmony approach over the other approaches.

The selection of [RTR] over [ATR] in this chapter calls for further discussion. In the previous literature, both [ATR] and [RTR] have been proposed as the harmonic feature: for example, J.-H. Park (1983) and B.-G. Lee (1985) used the feature [ATR], whereas J. Kim (1988a, 1993, 1999) and J.-K. Kim (2000) used the feature [RTR]. In most cases, the two tongue root features seem to be used interchangeably in such a way that [ $\alpha$ ATR] is considered to be the same as [ $-\alpha$ RTR] (cf. Archangeli & Pulleyblank, 1994).

However, under the assumption that [ATR] and [RTR] are two distinct features, a selection must be made. The neutralization of / $\Lambda$ / into its harmonic counterpart / $i$ / in non-initial syllables, also known as the so-called first merger of / $\Lambda$ /, reveals the polarity of the relevant tongue root feature. Since neutralization rules are generally assumed to eliminate marked values in favor of unmarked ones (Clements & Hume,

1995, p. 263; Rice, 2007), the merger pattern indicates that /ʌ/ has the marked value, thus justifying the RTR analysis of Middle Korean.

(22) The first merger of /ʌ/ with /i/ in non-initial syllables in the 15<sup>th</sup> to 16<sup>th</sup> centuries (K.-M. Lee & Ramsey, 2011, p. 158f.)

나ᄃᆞᆫ내	<i>nakonay</i>	/nakʌnaj/	>	나그내	<i>nakunay</i>	/nakɨnaj/	‘stranger, guest’
기ᄃᆞᆫ마	<i>kiloma</i>	/kilʌma/	>	기르마	<i>kiluma</i>	/kilɨma/	‘packsaddle’
도ᄃᆞᆫ	<i>twocok</i>	/tocʌk/	>	도ᄃᆞᆫ	<i>twocuk</i>	/tocɨk/	‘thief’
마ᄃᆞᆫ	<i>mazol</i>	/mazʌ/	>	마ᄃᆞᆫ	<i>mazul</i>	/mazɨ/	‘government office’
ᄃᆞᆫᄃᆞᆫ	<i>kolochi-</i>	/kʌʌcʰi-/	>	ᄃᆞᆫᄃᆞᆫ	<i>koluchi-</i>	/kʌɨcʰi-/	‘to teach’

Note that /ʌ/ is retained in initial syllables as can be seen in the last example, i.e., *kolochi-* /kʌʌcʰi-/ > *koluchi-* /kʌɨcʰi-/ ‘to teach.’ The initial /ʌ/ remained unchanged until the eighteenth century when it started to merge with /a/ (the so called second merger). This will be discussed in the next section.

The merger-by-neutralization pattern (/ʌ/ > /i/) is suggestive for the ordering of [RTR]. Recall the Trubetzkoyan diagnostics for feature hierarchy: unneutralizable features are ordered above neutralizable ones (Dresher, 2009, p. 73; Trubetzkoy, 1969). Since [RTR] is the only neutralizable feature in MK, it would be highly reasonable to rank it at the bottom of the hierarchy (Minimal Contrast Principle; see Chapter 1).

In addition, there are several pieces of empirical evidence that the RTR contrast is the weakest of all in Middle Korean. First, the phonemic contrast based on [RTR] may not be strong enough to differentiate words. Rather, it is often used for the allomorphic variants in suffixal RTR vowel harmony (e.g., topic particle *-on/-un*, past tense *-ess-/-ass-*, among many others) which share the same meaning and grammatical function. Similarly, sound-symbolic mimetic/onomatopoeic words and color terms (I. Lee &

Ramsey, 2000, pp. 120–125) also show alternations based on [RTR]<sup>17</sup> with only minor connotational differences. For example, the sound symbolism in color terms is used to “distinguish the relative lightness and darkness” of the same basic color word. In the pairs such as *ppalkah-* ~ *ppelkeh-* ‘red’ and *nolah-* ~ *nwuleh-* ‘yellow,’ the first form of each pair describes “bright and vivid colors,” while the second form describes “dark and muddied colors” (I. Lee & Ramsey, 2000, p. 123). Second, the fact that the misspellings in Middle Korean texts were made mainly between the RTR counterparts (K.-K. Oh, 1993; as cited in J.-H. Park, 2000, p. 7f.) also shows that the RTR contrast, unlike others, is easily confusable (or is being lost), possibly due to its lowest ranking.

(23) Misspelling between the RTR pairs in Middle Korean texts (K.-K. Oh, 1993)

a. misspelling between  $\cdot o$  (/ʌ/) and  $— u$  (/i/)

우르늑니	<i>wulq̄oni</i>	<TS 九 2>	우르고	<i>wul<u>u</u>kwo</i>	<WS 七 35>
흐르늑다	<i>hulq̄nota</i>	<TS 七 25>	흐르게	<i>hul<u>u</u>key</i>	<TS 八 37>
더르니	<i>tyelq̄ni</i>	<TS 七 15>	더르게	<i>tyel<u>u</u>key</i>	<TS 十五 55>
므르똥헛니	<i>mulq̄to<sup>h</sup>shoni</i>	<KS 二 72>	므르디	<i>mul<u>u</u>ti</i>	<SS 十三 4>
부르실	<i>pwulq̄sil</i>	<WS 十四 67>	부를씨라	<i>pwul<u>u</u>lssila</i>	<WS 序 7>
아즐헛야	<i>acq̄lhoya</i>	<NE 二 25>	아즐헛며	<i>ac<u>u</u>lhomye</i>	<KP 上 2>

b. misspelling between  $\perp wo$  (/o/) and  $\top wu$  (/u/)

넛미옴	<i>nuysmuyy<u>o</u>m</i>	<KK 六 23>	넛미유메	<i>nuysmuyy<u>u</u>m</i>	<KP 上 65>
일호믄	<i>ilh<u>w</u>omun</i>	<SS 十三 29>	일후믄	<i>ilh<u>w</u>umun</i>	<SS 十三 29>
비록	<i>pil<u>w</u>ok</i>	<TS 十七 7>	비룩	<i>pil<u>w</u>uk</i>	<TS 十七 4>
무로피	<i>mwul<u>w</u>ophi</i>	<KK 一 59>	무루피	<i>mwul<u>w</u>uphi</i>	<KK 一 89>

<sup>17</sup> Due to the historical change in the vowel system, the sound-symbolic harmony and the alternations in color terms in Modern Korean cannot be explained solely in terms of RTR contrast. See I. Lee & Ramsey (2000, p. 122) and J.-K. Kim (2000) for the detail.



구름	<i>kwul<u>w</u>om</i>	<TS 十 22>	구름	<i>kwul<u>w</u>um</i>	<TS 十 30>
곶구모	<i>kwoskwum<u>w</u>o</i>	<KK 一 48>	곶구무	<i>kwoskwum<u>w</u>u</i>	<KK 一 42>

c. misspelling between ㅏ *a* (/a/) and ㅓ *e* (/ə/)

구지람	<i>kwucil<u>a</u>m</i>	<NE 九 103>	구지럼	<i>kwucil<u>e</u>m</i>	<SS 十七 30>
아비	<i><u>a</u>pi</i>	<WS 十七 21>	어비	<i><u>e</u>pi</i>	<YP52>
저재	<i>cyec<u>a</u>y</i>	<YP6>	저제	<i>cyec<u>e</u>y</i>	<TS 七 16>
부채	<i>pwuch<u>a</u>y</i>	<TS 廿五 24>	부제	<i>pwuch<u>e</u>y</i>	<TS 十 36>
복상화	<i>pwoksy<u>a</u>nghwa</i>	<KP 上 21>	복성화	<i>pwoksy<u>e</u>nghwa</i>	<KP 下 67>
언맛	<i>en<u>a</u>s</i>	<WS 十七 44>	언메잇가	<i>en<u>e</u>myiska</i>	<WS 八 81>

There is also a line of research which characterizes vowel harmony as an enhancement of the perception of weak vowels (more concretely, weak vowel features) (Kaun, 1995, 2004; Suomi, 1983; Walker, 2005). Under this view, the existence of vowel harmony would reversely evidence the weakness of the harmonic feature. Thus, the RTR harmony itself (without any other parasitic harmony) may be a clear manifestation of the weak contrastiveness of [RTR].

### 3.2.3. Consequences of the contrastive hierarchy analysis

The contrastive hierarchy analysis presented so far brings about a number of desirable consequences for the analysis of the phonology of Middle Korean.

First of all, the proposed contrastive hierarchy gives a simple but plausible account for the transparency of the neutral vowel /i/ in Middle Korean. For the vowel /i/, the feature [coronal] alone is contrastive, while the other features [low], [labial], and [RTR] are all redundant. Thus, although /i/ is phonetically a non-RTR vowel, it cannot trigger nor block the vowel harmony. Even if we accept the view that the neutrality of /i/ is a consequence of the hypothesized merger between non-RTR /i/ and RTR \*/i/, we don't

need to postulate two *i*'s synchronically to account for the case of “neutral-vowel-only” stems in (9) (contra J.-H. Park, 1994; J.-H. Park & Kwon, 2009).

Second, the unmarkedness of /i/ and /ʌ/ as epenthetic vowels also receives proper treatment: they always belong to the unmarked set when the SDA applies and divides the inventory into the marked and the unmarked sets with respect to [coronal], [low], and [labial]. The hierarchical ordering of these features ensures that the RTR-ness of the unmarked vowel /ʌ/ is less contrastive than the coronality of /i/, the lowness of /ə/, the labiality of /u/, although they all share the property of having only one marked (positive) feature specification.

Third, the current analysis does not suffer from “the problem of too many features,” since all and only contrastive features are specified (Dresher, 2009; D. C. Hall, 2007). The contrastive hierarchy in (14) employs only one height feature, i.e., [low] and analyzes Middle Korean as a two-height system, not as a three-height system as has been conventionally assumed. It follows that the previous interpretation of vowel height should be changed accordingly. For example, /ə/ is not a mid (or open-mid) but a low vowel like /a/. /o/ is not a mid (or close-mid) but a high (non-low) vowel like /u/. /ʌ/ is not a low or mid but a high vowel like /i/. Since all the harmonic pairs /ə/ ~ /a/, /u/ ~ /o/, and /i/ ~ /ʌ/ share the same height, it is now possible to formulate the vowel harmony process as spreading of a single feature, i.e., [RTR]. The two-height analysis is typologically (from the Altaic perspectives, whether genetic or areal) more plausible as well, since all Mongolic (as we have seen in Chapter 3) and Tungusic languages (as we will see in Chapter 5) are analyzed as having a two-way height distinction at the phonological level no matter how many phonetic height distinctions they appear to have.

If the current analysis with only one height feature is correct, then how can we explain the apparent three-way height distinction at the phonetic level? It is well-

known that tongue body movement is concomitant with tongue root movement. So when the tongue root is advanced, for example, the tongue body is pushed upward (and forward as well). In contrast, when the tongue root is retracted, the tongue body is pulled downward (and backward as well) (Archangeli & Pulleyblank, 1994; Lindau, 1974; Vaux, 2009). This implicational relation between the tongue root and the tongue body movement is expressed in the terms *sympathetic* and *antagonistic* feature combinations, as already introduced in §2.2.3.4. The sympathetic feature combinations between tongue body raising and tongue root advancement or between tongue body lowering and tongue root retraction result in the enhancement of the acoustic effects: the lowering of F1 in the former and the raising of F1 in the latter, producing canonical high vowels and low vowels, respectively. By contrast, the antagonistic feature combinations between tongue body raising and tongue root retraction or between tongue body lowering and tongue root advancement counteract each other, resulting in cancellation of the acoustic realization of each feature (Archangeli & Pulleyblank, 1994, p. 248).

Based on the notion of sympathetic/antagonistic feature combination, J.-K. Kim (2000) hypothesizes the acoustic effects of feature combination between tongue body feature ([high]) and tongue root feature ([RTR]) in the Middle Korean vowel system as follows:

(24) Feature combination and acoustic/phonetic effects (J.-K. Kim, 2000, p. 188)

a. Sympathetic combinations

Tongue Body	Tongue Root	Acoustic/Phonetic Effects
raising [+high]	advancement [-RTR]	- additive F1 lowering - a canonical high vowel
lowering [-high]	retraction [+RTR]	- additive F1 raising

- a canonical low vowel

b. Antagonistic combinations

Tongue Body	Tongue Root	Acoustic/Phonetic Effects
raising [+high]	retraction [+RTR]	- subtracted F1 lowering - a lowered high V or a mid V
lowering [-high]	advancement [-RTR]	- subtracted F1 raising - a raised low V or a mid V

When applied to Middle Korean vowels, the sympathetic combination between [+high] (= [-low] in my analysis) and [-RTR] of /i/ and /u/ results in additive F1 lowering, producing canonical high vowels. Similarly, the combination between [-high] (= [+low]) and [+RTR] of /a/ results in additive F1 raising, producing a canonical low vowel. By contrast, the antagonistic combination found in [+high(-low), +RTR] of /ʌ, o/ and [-high(+low), -RTR] of /ə/ results in lowered high vowels and raised low vowels, respectively, thus yielding the three-height distinction in the phonetics out of the two-height contrast in the phonology. This is summarized below:

(25) Feature combination and the phonetic realization of Middle Korean vowels

a. Sympathetic combinations

/i, u/ [-low, -RTR] → additive F1 lowering → canonical high Vs

/a/ [+low, +RTR] → additive F1 raising → canonical low V

b. Antagonistic combinations

/ʌ, o/ [-low, +RTR] → subtracted F1 lowering → lowered high V (=mid V)

/ə/ [+low, -RTR] → subtracted F1 raising → raised low V (=mid V)

Recall that, when the acoustic effect of feature combination is relatively large, it can result in a “phonetic overlap” between a retracted high vowel and an advanced mid vowel. This may actually have happened between /ʌ/ and /ə/ in Middle Korean,<sup>18</sup> as conjectured by J.-K. Kim (2000). This is illustrated in the following diagrams.

(26) Phonetic overlap between /ʌ/ and /ə/ (J.-K. Kim, 2000, p. 189)

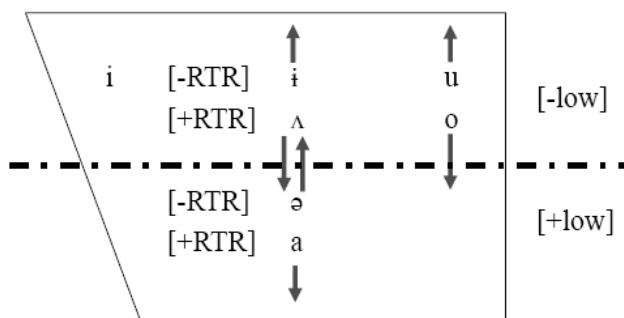

Thus, the seeming discrepancy between the “phonetic” vowel system in (3) and the “phonological” vowel system in (13) is resolved in a principled way.

The assumed phonetic overlap is indeed supported by the sporadic change of /ʌ/ into /ə/ given below:

(27) Sporadic change of /ʌ/ into /ə/ in Middle Korean (W.-J. Kim, 1978, p. 132)<sup>19,20</sup>

<sup>18</sup> As pointed out by John Whitman (p.c.), this phonetic overlap between /ʌ/ and /ə/ (relatively large effect of the lowering (and backing) of /ʌ/ in particular) would have been possible due to the lack of low rounded vowel(s) in the MK vowel inventory.

<sup>19</sup> W.-J. Kim (1978, pp. 132–134) regarded this change as the last stage effect of the loss of /ʌ/ after the first (/ʌ/ > /i/) and the second merger (/ʌ/ > /a/) are all finished. He also conjectured that this change may be related to the backing of /ə/ (a part of his vowel shift theory).

<sup>20</sup> It is well-known that Jeju Korean retains /ʌ/. However, S.-C. Jeong (1995, p. 46f.) observed that in non-initial syllables Jeju Korean experienced the same /ʌ/ > /i/ merger as other dialects. Interestingly, a few words have retained /ʌ/ in non-initial syllables as shown below:

/ʌ/	/ə/	
늑밭 <i>nomol</i>	늑뻐 <i>nomel</i>	‘wild vegetables’
오늘 <i>wonol</i>	오뻐 <i>wonel</i>	‘oday’

턱	<i>thok</i>	/tʰʌk/	>	턱	<i>thək</i>	/tʰək/	‘jaw’
벌	<i>pol</i>	/pʌl/	>	벌	<i>pel</i>	/pəl/	‘punishment’
일컫-	<i>ilkhot-</i>	/ilkʰʌt-/	>	일컫-	<i>ilkhet-</i>	/ilkʰət-/	‘call’

If the reconstruction of  $*y\Lambda$  (/jʌ/) for  $y\partial$  (/jə/) by K.-M. Lee (1972b) is correct, the following examples are also highly suggestive of the phonetic overlap between /ʌ/ and /ə/.

(28) /jə/ <  $*j\Lambda$ / (K.-M. Lee, 1972b)

여라	<i>yela</i>	/jəla/	<	$*j\Lambda la$	‘several’
여덟	<i>yetolp</i>	/jətʌlp/	<	$*j\Lambda tʌlp$	‘eight’
보선	<i>pwo syen</i>	/posjən/	<	$*posj\Lambda n$	‘Korean socks’
며느리	<i>myenoli</i>	/mjənʌli/	<	$*mj\Lambda nʌli$	‘daughter-in-law’

At first glance, it is tempting to view the above data as an exception to the vowel harmony rule since the first and the second vowel belong to different harmonic groups: for example, in *yela* /jəra/ ‘several,’ /ə/ is a non-RTR vowel whereas /a/ is an RTR vowel. However, the seemingly disharmonic roots can be understood to have originated from harmonic roots, if K.-M. Lee’s reconstruction is correct. Note also that the change may be partly due to the coronality of the glide  $y$  (/j/).

---

베슬	<i>peysol</i>	베설	<i>peysel</i>	‘intestines’
아들	<i>atol</i>	아덜	<i>atel</i>	‘son’
모들	<i>mwomol</i>	모덜	<i>mwomel</i>	‘buckwheat’

Note that these words commonly have /l/ after /ʌ/ and that they show free variation with variants with /ə/.

If /ʌ/ and /ə/ indeed overlapped in their phonetic realization, we might predict on a purely phonetic basis that it should be /ə/ that /ʌ/ must merge with. Despite the phonetic overlap with /ə/, however, /ʌ/ merged with /i/ and /a/ more extensively in the course of its loss. Surely the phonetic overlap between the two vowels, /ʌ/ into /ə/, may be one of the motivations behind the historical loss of /ʌ/. However, it cannot fully account for the systematic merger pattern. Rather, it seems that phonological contrast plays a key role in determining which vowel is subject to neutralization (and merger) in which direction. I will revisit this point when I deal with the second merger of /ʌ/ in the next section.

The last point I would like to make is that the contrastive hierarchy analysis in this thesis shed new light on the early description on the Middle Korean vowels by the inventor(s) of the Korean alphabet *Hwunminchengum*<sup>21</sup> (promulgated in 1446). The description can be translated as follows:

- (29) Description of the Middle Korean vowels in *Hwunminchengum* Haylyey Ceycahay (K.-M. Lee & Ramsey, 2011, p. 120)<sup>22</sup>
- a. With ◦ [ʌ], the tongue retracts and the pronunciation is deep.
  - b. With ◡ [i], the tongue retracts a little and the pronunciation is neither deep nor shallow.
  - c. With | [i], the tongue does not retract and the pronunciation is shallow.
  - d. ◡ [o] is the same as /ʌ/, only the mouth is contracted.
  - e. ◡ [a] is the same as /ʌ/, only the mouth is spread.
  - f. ◡ [u] is the same as /i/, only the mouth is contracted.

---

<sup>21</sup> *Hwunminchengum* is used to refer to the text as well as the alphabet.

<sup>22</sup> See also S. Kang (1997, p. 120), Kim-Renaud (1997, p. 172f.), and I. Lee & Ramsey (2000, pp. 37–39) for different versions of English translation.

g. ㅓ [ə] is the same as /i/, only the mouth is spread.

The above description, which was made over a half millenium ago, may not be identical to the current analysis. However, it resembles the contrastive hierarchy analysis in many respects.

Note, first of all, that only three contrastive features are identified: [retracted tongue], [contracted mouth], and [spread mouth], which can be viewed as a close equivalent to [RTR], [labial], and [low], respectively, in my analysis.<sup>23</sup> The description on the pronunciation in terms of “deep” vs. “shallow” makes exactly the same ternary distinction as [retracted tongue], and thus can be viewed as acoustic/perceptual effect of the articulatory feature [retracted tongue] (J. Kim, 1988a). No further conceivable distinctions are made for, e.g., the relatively high vs. low vowel pairs (between /i/ and /ʌ/, /u/ and /o/, and /ə/ and /a/) and the central vs. back vowel pairs.

Second, the polarity of the proposed features is identical to that of the features selected in my analysis: for instance, contracted (/u/ and /o/) and spread vowels (/ə/ and /a/) are more marked than plain vowels (/i/ and /ʌ/).

Third, only contrastive, not redundant, features are specified for individual phonemes. For example, /i/ is only specified with respect to the ternary feature [retracted tongue]. All the other features [contracted mouth] and [spread mouth] are not specified for /i/, although they are contrastive for other vowels.

Fourth, features have their own scopes. Apparently, [retracted tongue] takes scope over [contracted mouth] and [spread mouth]. Also, although it is not the case that one

---

<sup>23</sup> [retracted tongue] is used as a ternary feature in *Hwunmincengum* with more distinctive functions than our binary feature [RTR]. Recall that we used [coronal] to distinguish /i/ from all the other vowels.



takes scope over the other, [contracted mouth] and [spread mouth] have distinct scopes: [contracted mouth] is relevant only to the contrast between /i, ʌ/ and /u, o/, whereas [spread mouth] is relevant only to the contrast between /i, ʌ/ and /ə, a/.

### 3.3. Vowel contrast in Early Modern Korean

The RTR-based two-height vowel system in Middle Korean has changed into the labial contrast-based three-height vowel system in Early Modern Korean. In this section, I will investigate this rather revolutionary change in detail, with a special focus on the so-called two-step merger of /ʌ/.

I will start showing how the Early Modern vowel system apparently differs from the Middle Korean vowel system. Then, I will introduce the first stage of the two-step loss of /ʌ/ and its consequences, namely, the collapse of RTR vowel harmony and the change in the contrastive hierarchy. Several pieces of supportive evidence will be provided next.

#### 3.3.1. Vowel system in Early Modern Korean

Unlike the Middle Korean vowel system (30)a which has been much debated, a general consensus has been reached on the Early Modern Korean vowel system (30)b.

#### (30) Vowel system in Middle and Early Modern Korean

a. Middle Korean

(K.-M. Lee, 1972a, p. 137)

ㅣ i	ㅡ i	ㅍ u
	ㅓ ə	ㅗ o
	ㅑ a	ㅓ ʌ

b. Early Modern Korean in 19<sup>th</sup> century

(K.-M. Lee, 1972a, p. 202)

ㅣ i	ㅡ i	ㅍ u
	ㅓ e	ㅓ ə
	ㅑ ε	ㅑ a

When we compare the two systems, it is readily noticeable that there is a significant change in the vowel inventory. Middle Korean has seven vowels, whereas Early Modern Korean has eight vowels. This is the combinatory result of the loss of /ʌ/ and the addition of two non-high front vowels, /e, ε/. Besides this visible difference in the inventory, there are other important changes in Early Modern Korean: the collapse of the vowel harmony system and the change in the number of vowel height contrast at the phonological level. These differences between the Middle Korean vowel system and the Early Modern Korean vowel system are summarized as follows:

- (31) Characteristics of the EModK vowel system in comparison with the MK vowel system
- a. Loss of /ʌ/ by the so-called two-step merger
  - b. Creation of new non-high coronal (front) vowels by monophthongization of /əj, aj/ to /e, ε/
  - c. Collapse of vowel harmony<sup>24</sup>
  - d. Three-way vowel height distinction: /ə/ and /o/ are reanalyzed as mid vowels.

### 3.3.2. *Change of contrastive hierarchy and the two-step merger of /ʌ/*

It is generally accepted that /ʌ/ in MK undertook two distinct steps of merger in the course of its complete disappearance in EModK: the first merger with /i/ in non-initial syllables in the sixteenth century, as in (18), and the second merger with /a/ in initial

---

<sup>24</sup> The residual vowel harmony in Modern Korean is highly limited in its scope: it is found only either in (i) the affixation of *a/ə*-initial suffixes in verbal morphology or in ideophones. This residual harmony is hard to analyze straightforwardly without taking the diachronic change into consideration. See J.-K. Kim (2000, pp. 254–347) for the detailed harmonic patterns in (Standard) Seoul Korean and a constraint-based analysis.

syllables in the mid-eighteenth century, as in (19) (K.-M. Lee, 1972b, pp. 200–201, 1978, pp. 76–95).

(32) The first merger of /ʌ/ with /i/ in non-initial syllables in 15<sup>th</sup>-16<sup>th</sup> century (MK)

/hanʌl/ > /hanil/ ‘sky’      /nakʌnaj/ > /nakine/ ‘wanderer’  
 /talʌ-/ > /tali-/ ‘different’      /kʌlʌc<sup>hi</sup>-/ > /kalic<sup>hi</sup>-/ ‘to teach’

(33) The second merger of /ʌ/ with /a/ in initial syllables in 18<sup>th</sup> century (EModK)

/pʌlam/ > /palam/ ‘wind’      /p<sup>h</sup>ʌli/ > /p<sup>h</sup>ali/ ‘fly’  
 /tʌl/ > /tal/ ‘moon’      /hʌ-/ > /ha-/ ‘do’  
 /kʌlʌc<sup>hi</sup>-/ > /kalic<sup>hi</sup>-/ ‘to teach’

These different merger patterns have drawn much attention in the previous literature. Nonetheless, the formal mechanism behind the patterns has never been fully accounted for.

In the present analysis, the first and the second merger receive a unified analysis in terms of phonological neutralization of the lowest ranked contrast. The different merger pattern is due to a change in the contrastive hierarchy.

### 3.3.2.1. The first merger of /ʌ/ under the MK contrastive hierarchy

Let us first consider the first merger. I analyze the first merger as positional RTR neutralization under the MK contrastive hierarchy [coronal] > [low] > [labial] > [RTR] given below.

(34) Contrastive hierarchy for Middle Korean

a. SDA: [coronal] > [low] > [labial] > [RTR]

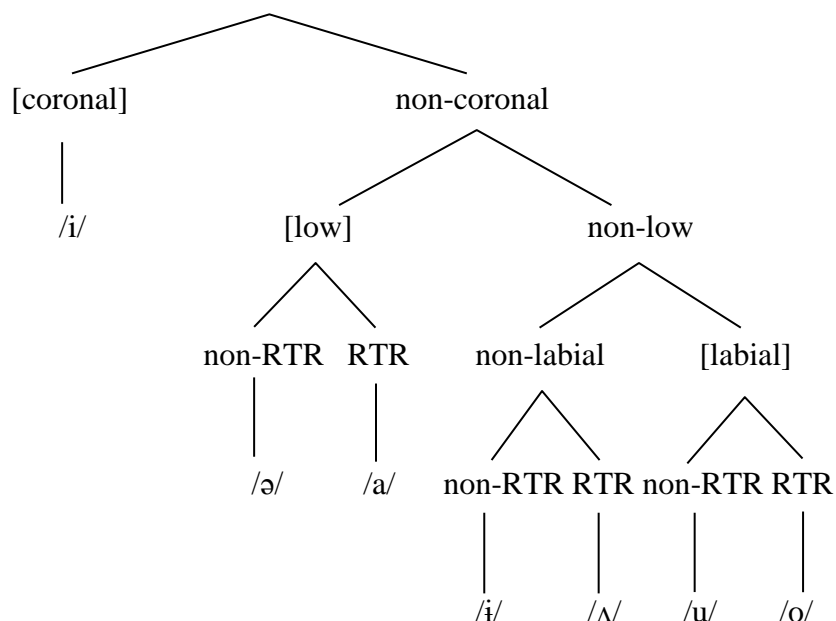

b. Output specifications

- /i/ = [+cor]    /i/ = [-cor, -low, -lab, -RTR]    /u/ = [-cor, -low, +lab, -RTR]  
 /ʌ/ = [-cor, -low, -lab, +RTR]    /o/ = [-cor, -low, +lab, +RTR]  
 /ə/ = [-cor, +low, -RTR]  
 /a/ = [-cor, +low, +RTR]

Recall the fact that the misspelling examples in §3.2.2, (23), are not limited to /ʌ/~i/, but includes /u~/o/ and /ə~/a/: this indicates that what is relevant is the whole natural class (defined by RTR) rather than an individual pair (Han, 1990, pp. 122–128). Also, they all share the same positional restriction (non-initial syllable), which also supports the positional neutralization analysis.

Then, a question arises: why is it only /ʌ/, not /o, a/, that disappeared?

We find the answer in the phonetics. There is a phonetic motivation for /ʌ/, but not for /o, a/ to undergo a merger: the phonetic overlap between /ʌ/ and /ə/ due to the antagonism of certain combinatory specification of tongue body and tongue root features. The vowel /o/ has the antagonistic combinations as well, between [-low] and

[+RTR], but roundedness suffices to distinguish it from other ‘phonetic’ mid vowels. In case of /a/, the sympathetic combination between [+low] and [+RTR] makes it phonetically more distinguishable. Thus, only /ʌ/ has the phonetic motivation to be changed.

The current contrastive hierarchy analysis also gives an account of why the merger was with /i/, not with /ə/ despite the phonetic overlap, nor with /a/ or /o/ as in the second merger. Under the MK contrastive hierarchy, the vowel /i/ is the only phoneme that /ʌ/ *minimally contrasts* with, that is the only phoneme that /ʌ/ can phonologically merge into. Recall that this reasoning is based on the working hypothesis on the notion of Minimal Contrast Principle introduced in §**Error! Reference source not found.**

### 3.3.2.2. The consequences of the first merger

The first merger of /ʌ/, the RTR neutralization between /ʌ/ and /i/ in weak positions (non-initial syllables), has the effect of destabilizing the contrastive status of [RTR] in the whole system and finally leads to the loss of the RTR-based vowel harmony.<sup>25</sup>

Confronted with the loss of [RTR] as a contrastive feature, the contrast between the remaining harmonic pairs (/u/ ~ /o/ and /ə/ ~ /a/) is now in grave peril. However, recall

---

<sup>25</sup> The first merger is considered to be one of the most crucial causes of the collapse of Middle Korean vowel harmony (K.-M. Lee, 1978, p. 93). We might say, among the three harmonic pairs /i/~/ʌ/, /u/~/o/, and /ə/~/a/, the /i/~/ʌ/ pair is the most important in the sense of grammatical functional load, because it is found in the broadest range of allomorphic alternations of grammatical particles and verbal suffixes. Examples include but not limited to the topic particle -ʌn/-in, the accusative particle -ʌl/-il, the genitive particle -ʌy/-iy, and the epenthetic vowels before various consonant-initial suffixes and endings such as -(ʌ)ni/-(i)ni ‘because’, -(ʌ)myən/-(i)myən ‘if’, the honorific marker -(ʌ)si/-(i)si, the instrumental particle -(ʌ)lo/-(i)lo, etc). On the contrary, Han (1990) provides an explanation in the opposite direction, claiming that the weakening of the RTR (“selchwuk” in his term) contrast, that is to say, the collapse of the vowel harmony, caused the first merger of /ʌ/, not vice versa. If so, a question naturally arises: what caused the collapse of the vowel harmony then? He points out the neutrality of /i/ as a potential cause. However, this argument would sound circular, if we accept the view that the neutrality of /i/ in Middle Korean is also the result of RTR neutralization in earlier Korean (J.-H. Park, 1994, 2002) as is the case in many Altaic languages (Cenggeltei, 1982; J. Kim, 1989, 1993).

that “a decrease in F1 (or, impressionistically, greater auditory height) can result either from pharyngeal cavity expansion (i.e., [+ATR]) or from tongue body raising (i.e., [+high])” (Casali 2008, p. 508; see also §1.3.2). Therefore, the primary auditory difference in F1 can be maintained by the phonetic effect of height features. Since the feature [low] is already in use, a new height feature [high] is introduced to the hierarchy, in a principled way as will be discussed shortly.

With two contrastive height features [high] and [low], the phonetic three-height distinction becomes phonological and /o/ and /ə/ become phonologically mid vowel. As a result, the RTR-based, two-way height system (a) turns into a labial contrast-based, three-way height system (c) where the previous “phonetic” three-way height distinction becomes a “phonological” one.<sup>26</sup> Note that all these reinterpretations could be done without any assumption on the phonetic change in the quality of vowels, except for the case of /Λ/.

### 3.3.2.3. Contrastivist analysis for the Early Modern Korean vowel system

This change in the vowel system from Middle Korean to Early Modern Korean can be characterized as a structural change of the contrastive hierarchy: a case of *fission* whereby a single height feature splits into two, as schematized below:

(35) Fission of [low]

a. MK            [coronal] > [low] > [labial] > [RTR]

↓

(loss of [RTR])

b. ???            [coronal] > **[low]** > [labial]

---

<sup>26</sup> This can be understood in terms of phonologization (Hyman, 1976): the lowering of /o/ (and /Λ/) and the raising of /ə/ as “intrinsic” byproducts of the “universal effect” of the relevant feature combinations between [RTR] and [low] become unpredictable and thus “extrinsic” up against the loss of [RTR].

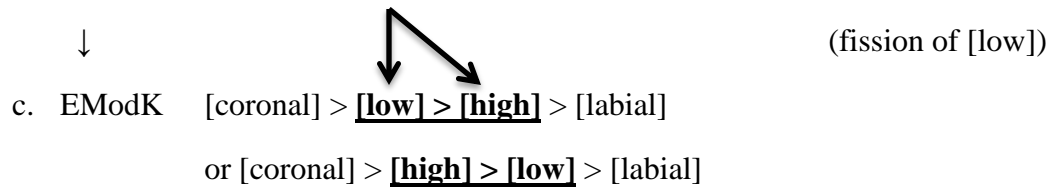

Faced with the situation where [RTR] no longer serves as a contrastive feature (35)a, speakers of Early Modern Korean may have realized that the remaining three features, [coronal], [low], and [labial], cannot exhaustively distinguish all the vowel phonemes. This is particularly because [coronal] is only used to separate /i/ from the other six vowels which logically requires at least three features to be properly distinguished (35)b. The split of [low] into [high] and [low] solves this problem (35)c, providing an additional contrastive feature.

Several things are to be noted here. First, the loss of [RTR] and the addition of [high] (by the fission of [low]) should be regarded as concomitant rather than serial. Second, by assumption, there are two possible results of the fission, that is, [low] > [high] and [high] > [low]: there seems to be no theoretical or empirical reason to believe that one ranking is more preferable than the other at this point. However, I opt for [low] > [high] since most modern South Korean dialects seem to have experienced mid vowel raising in the 19<sup>th</sup> century which only affected the contrast between high and mid vowels to the exclusion of low vowels. On the other hand, the relative hierarchy between the two height features does not seem to be crucial in North Korean dialects. See §3.4 for more details. Third, the “fissional” change from (35)a to (35)c obeys the Adjacency Principle by which changes in contrastive hierarchy (promotion/demotion and fusion/fission) are constrained to occur between two neighboring features. Finally, the change is “conservative” in the sense that the fission has taken place where the original [low] was located.

The contrastive hierarchy for Early Modern Korean is given below:

(36) Contrastive hierarchy for Early Modern Korean in the 16<sup>th</sup> century<sup>27</sup>

a. SDA<sub>2</sub>: [coronal] > [low] > [high] > [labial]

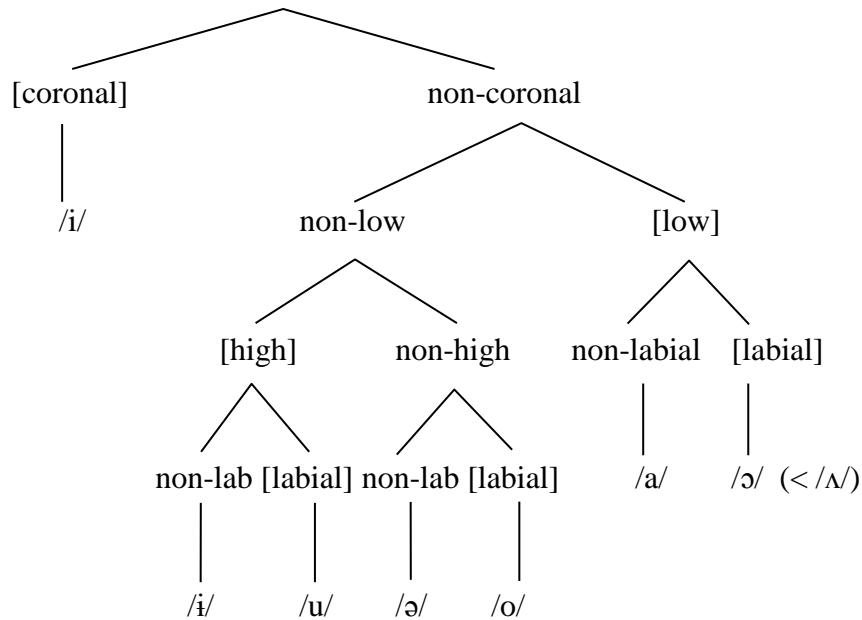

b. Output specifications

/i/ = [+cor]	/i/ = [-cor, -low, +high, -lab]	/u/ = [-cor, -low, +high, +lab]
	/ə/ = [-cor, -low, -high, -lab]	/o/ = [-cor, -low, -high, +lab]
	/a/ = [-cor, +low, -lab]	/ɔ/ = [-cor, +low, +lab]

There are several noticeable changes from the MK to the EModK hierarchy, but the most important one seems to be the loss of RTR contrast and the introduction of [high]. Also, the minimal contrast based on [RTR] has been replaced by the minimal [labial]

<sup>27</sup> The creation of new coronal vowels is not reflected in the diagram at this point, as it is considered to be a change at a later stage after the establishment of the hierarchy in (36). Therefore the contrastive hierarchy in (36) should be understood as that of the initial stage of Early Modern Korean around the time when the first merger of /ʌ/ was completed and the three-height distinction was established. It seems to be under this hierarchy that the second merger of /ʌ/, the creation of new coronal vowels, and many other changes took place.



contrast. Note that /ʌ/, reanalyzed as /ɔ/, is still included in (36), but now contrasts with /a/ in terms of the minimal [labial] contrast, not with /i/ in terms of [RTR] any more.

#### 3.3.2.4. Reinterpretation of the remaining /ʌ/

We saw the first merger of /ʌ/ has a positional restriction: only /ʌ/ in non-initial syllables underwent the merger, whereas /ʌ/ in initial syllables survived. Then, is this survivor the same as before? I argue that the MK /ʌ/ in initial syllables changed into /ɔ/, phonetically as well as phonologically, under the proposed EModK contrastive hierarchy: its feature specifications have changed from [-cor, -low, -lab, +RTR] to [-cor, +low, +lab].

The vowel /ʌ/ would still be in phonetic overlap with /ə/ if it is where it used to be (see (26)). However, due to the loss of [RTR] feature, it cannot be phonologically distinguished from /ə/. Therefore, it somehow moves to a “safer” region that is not taken by any other vowel (cf. J. Kim, 1993). There seem to be two possible directions: (i) vowel fronting and (ii) vowel lowering with labialization. Given the contrastive hierarchy [coronal] > [low] > [labial], the change of [coronal] in vowel fronting would cost more than the change of [low] and [labial] (recall the basic assumption of OT) in vowel lowering and rounding. Also, the direction of (i) vowel fronting is not preferred in terms of Hyman’s notion of *phonologization* (Hyman, 1976) since “fronting” is not “intrinsic” to [+RTR] vowels. In addition, there would be unwanted competition with secondary front vowels given the then ongoing creation of such vowels by umlaut (§3.3.3.1). Thus, acquiring [+labial] and [+low] specification, /ʌ/ is reanalyzed as the labial counterpart to /a/. If this change is what really happened to the vowel /ʌ/, it is

probably the only phonological change that involves some noticeable phonetic change as well.<sup>28</sup>

This hypothesized change of /ʌ/ has an actual manifestation in the development of the Jeju Korean vowel system (S.-C. Jeong, 1988, 1995), where the unrounded mid back vowel /ʌ/ of MK changed into the rounded low back vowel /ɔ/.<sup>29</sup> Since this change happened in Jeju Korean, it might have happened in other dialects as well although apparently it did not survive.

The labial contrast, instead of the RTR contrast, forms the basis for the opposition between vowels in Early Modern Korean: /i/ contrasts with /u/, /ə/ contrasts with /o/, and /a/ contrasts with /ɔ/ in initial syllables. Recall that in Middle Korean there was no labial contrast in low vowels (/ə/ and /a/). Also, the non-labial counterpart to /o/ was /ʌ/, not /ə/.

In the next section, I will present evidence for this new labial contrast as well as the three-way height distinction in Early Modern Korean.

### *3.3.3. Evidence for the three-height distinction and the labial contrast*

---

<sup>28</sup> It might be the case that the “phonetic” change is minimal and not so big as one might expect. Recall that the acoustic effect of tongue root movement can be relatively large (Archangeli & Pulleyblank, 1994, p. 249). We cannot exclude the possibility that the retracted non-low vowel /ʌ/ in MK was realized lower than a canonical mid vowel. If /ʌ/ in MK is phonetically somewhere between mid and low region, it can be interpreted either non-low or low, depending on the system of contrasts it enters into: when it contrasts with a non-low vowel /i/, it is analyzed as non-low too; when it contrasts with a low vowel /a/ (more precisely, when it needs to contrast with /a/), it is analyzed as low. Once it is interpreted as a low back rounded vowel by phonology, then it can be enhanced by phonetics to be a more canonical low rounded vowel.

<sup>29</sup> The labiality of /ɔ/ in modern Jeju dialect is confirmed by instrumental studies (Hyun, 1992 among others).



contrast between each non-labial/labial vowel pair: labialization for the pair /i/ and /u/, the delabialization for the pair /ə/ and /o/, and the second merger of /ʌ/ for the pair /a/ and /ʌ(=ɔ)/. Let's begin with the second merger of /ʌ/.

### 3.3.3.2.1. *The second merger of /ʌ/ with /a/*

The second merger of /ʌ/ (= /ɔ/) with /a/ in initial syllables in the 18<sup>th</sup> century which we have already seen in (33) marks the completion of the development of the labial contrast.<sup>31</sup> Recall that the first merger is analyzed as a positional RTR neutralization under the contrastive hierarchy [coronal] > [low] > [labial] > [RTR] of Middle Korean. Similarly, the second merger is analyzed as a labial neutralization under the contrastive hierarchy, [coronal] > [low] > [high] > [labial] of Early Modern Korean.

The second merger may have been triggered by the universal tendency that a low rounded vowel is not preferred (\*LowRound). However, the direction of the merger is not universal. Indeed, there are three types of the second merger of /ʌ/.

#### (38) Three types of the second merger of /ʌ/

	Merger pattern	Dialect
a. Type 1:	/ʌ/ > /a/	most dialects incl. Central Korean
b. Type 2:	/ʌ/ > /o/	modern Jeju Korean
c. Type 3:	i. /ʌ/ > /o/ after a labial C	South Cenla and Yukcin dialect
	ii. /ʌ/ > /a/ elsewhere	

---

<sup>31</sup> The second merger can also be considered to mark the completion of the development of three-way height contrast if we accept Han's (1990) claim that the second merger occurred after the creation of the new front vowels because the three front vowels /i, e, ε/ can be distinguished only by their height differences.

The first type is what we have already seen: /ʌ/ to /a/. This type is widely attested in most dialects including Central Korean. The second type is /ʌ/ to /o/, an ongoing process in modern Jeju Korean (T. Cho, Jun, Jung, & Ladefoged, 2000; S.-C. Jeong, 1995). The third type is a mixed type of the first two: /ʌ/ to /o/ when following a labial consonant (thus, more precisely, not a merger but an assimilation—labialization), but /ʌ/ to /a/ in all other contexts. Below are the examples which show the change of /ʌ/ into /o/ after a labial consonant in South Cenla and Yukcin dialects.<sup>32</sup>

(39) “Mixed” merger in Yukcin and South Cenla dialect (I. Lee & Ramsey, 2000, pp. 318–320):

a.	Yukjin	Middle Korean	Seoul Korean
‘horse’	/mol/	/mʌl/	말
‘fly’	/p <sup>h</sup> oli/	/p <sup>h</sup> ʌl/	파리
‘arm’	/p <sup>h</sup> ol/	/p <sup>h</sup> ʌl/	팔
‘redbean’	/p <sup>h</sup> ochi/	/p <sup>h</sup> ʌsk/	팥
b.	South Jeolla	Middle Korean	Seoul Korean
‘village’	/mosil/	/mʌzʌl/	마을
‘bright’	/polkt’a/	/pʌlkt’a/	밝다
‘dry’	/mollita/	/mʌlʌta/	마르다
‘sell’	/p <sup>h</sup> olta/	/p <sup>h</sup> ʌlta/	팔다

<sup>32</sup> Although I do not attempt to show the formal analysis of this mixed merger here, I believe this can be accounted for by positional faithfulness or markedness constraint interacting with context-free faithfulness/markedness analogous to the typical OT analysis of allophonic variation (Kager, 1999; McCarthy, 2002): e.g., Ident[lab]/[lab]\_\_\_ (or \*C[lab]V[non-lab]) » Ident[low] » \*LowRound, Ident[lab].

The vowel which /ʌ/ contrasts with has changed accordingly as the contrastive hierarchy has changed: [RTR] is relevant to the first merger, [labial] to the second merger, and [low] to the ongoing second merger in Jeju Korean (this will be dealt with in §3.4.4). Each feature is analyzed to be the lowest-ranked in the contrastive hierarchy at each stage.

### 3.3.3.2.2. Labialization

Another piece of evidence for the labial contrast, especially between /i/ and /u/, is labialization. In Early Modern Korean, the vowel /i/ after a labial consonant becomes its labial counterpart /u/, which is formalized as a rule below.

(40) Labialization: /i/ becomes /u/ after a labial consonant.

a. rule: 
$$\left[ \begin{array}{c} V \\ -cor \\ +high \end{array} \right] > [+lab] / \left[ \begin{array}{c} C \\ lab \end{array} \right] \text{---}$$

b. data: /miɭ/ > /mul/ ‘water’ /misim/ > /musin/ ‘what kind of’  
 /piɭ/ > /pul/ ‘fire’ /pilk-/ > /pulk-/ ‘red’  
 /p<sup>h</sup>iɭ/ > /p<sup>h</sup>ul/ ‘grass’ /p<sup>h</sup>iʒəŋkuj/ > /p<sup>h</sup>usəŋkwi/ ‘vegetables’

In addition to these examples, there are also examples which underwent the first merger followed by the labialization, that is, /ʌ/ > /i/ > /u/: e.g., /kʌmʌɭ/ > /kʌmiɭ/ > /kamul/ ‘drought.’

According to J.-S. Kim (1984, pp. 256–257) (see also Paek, 1988, p. 196), there was no labialization before the 17<sup>th</sup> century. Recall that in the Middle Korean contrastive hierarchy, [labial] was dominated by [RTR]. However, after the loss of [RTR], [labial] becomes the lowest-ranked feature. This may be related to the

emerging pattern of labialization (as well as delabialization). Also note that the timing overlap between the labialization and the second merger (Paek, 1988, p. 199).

### 3.3.3.2.3. *Delabialization*

In Middle Korean, the non-labial counterpart of /o/ was /ʌ/, although they were not in minimal contrast. After the loss of /ʌ/, /ə/ takes the place of /ʌ/ and becomes the non-labial counterpart of /o/. This is supported by the delabialization of /o/ to /ə/, which is estimated to have occurred in the late 18<sup>th</sup> century in Kyengki regional dialect, a sub-dialect of Central Korean (P.-G. Lee, 1970).

(41) Delabialization of mid vowel /o/ to /ə/ in late 18<sup>th</sup> century (P.-G. Lee, 1970)

- a. rule: 
$$\begin{bmatrix} \text{V} \\ -\text{cor} \\ -\text{high} \\ -\text{low} \end{bmatrix} > [-\text{lab}] / \begin{bmatrix} \text{C} \\ +\text{lab} \end{bmatrix} \_\_\_$$
- b. data:
- |           |   |           |                      |
|-----------|---|-----------|----------------------|
| /moncjə/  | > | /məncə/   | ‘ahead; first’       |
| /moncʌj/  | > | /mənci/   | ‘dust’               |
| /posjən/  | > | /pəsən/   | ‘Korean socks’       |
| /pontoki/ | > | /pənteki/ | ‘pupa’               |
| /posnamo/ | > | /pəsnamu/ | ‘cherry tree’        |
| /spom/    | > | /pʰjəm/   | ‘the span of a hand’ |

In Kyengki regional dialect, mid rounded vowel /o/ is delabialized to /ə/ after a labial consonant, which is the reverse of labialization in which high unrounded vowel /i/ is labialized to /u/ in the same environment (e.g., /mɪl/ > /mul/ ‘water’, /pɪl/ > /pul/ ‘fire’). This directional difference can be illustrated as follows (P.-G. Lee, 1970, p. 158):

- (42) i → u  
 ə ← o  
 a

The fact that delabialization has a different domain (mid vowel only) from labialization (and the second merger as well) implies that the relevant height feature has wider scope than [labial]. If [labial] takes scope over [high], for example, high and non-high (mid) vowels are predicted to undergo the same change, either labialization or delabialization (43)a. On the other hand, if [high] takes scope over [labial] as is the case with Kyengki dialect,<sup>33</sup> it is possible to have different phenomena depending on the height (43)b.

(43) Predicted scope of labialization and delabialization

- a. Labialization (or delabialization) will take place exclusively when [labial] > [high].

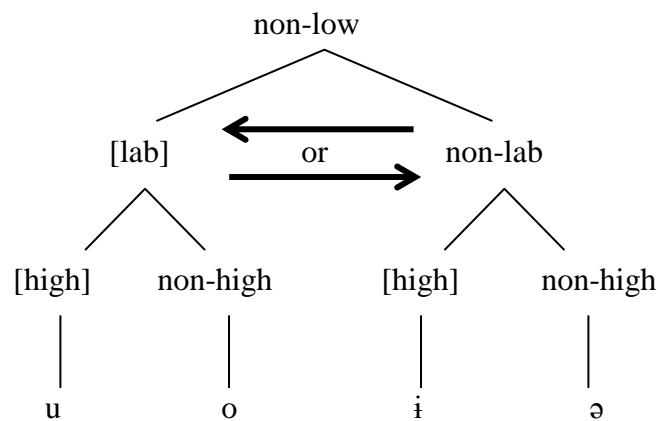

- b. Both labialization and delabialization are possible when [high] > [labial].

<sup>33</sup> I assume that [low] is ranked above [high] in Kyengki dialect (therefore [coronal] > [low] > [high] > [labial]) since it is a subdialect of Central Korean which is analyzed as having the same hierarchy [coronal] > [low] > [high] > [labial] (§3.4.3).



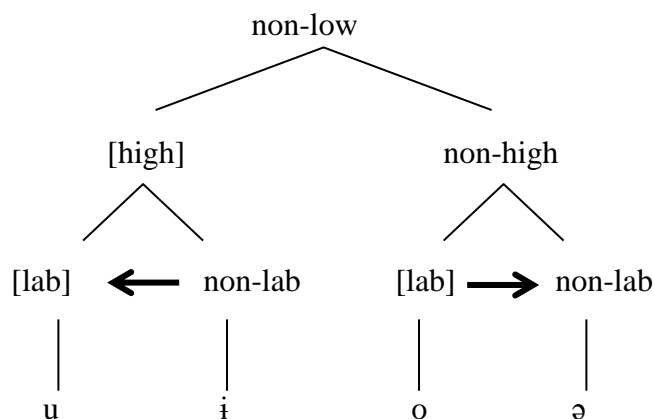

Thus, delabialization is considered to be evidence for the relative hierarchy [high] > [labial] (at least at this stage of Early Modern Korean) as well as evidence for the labial contrast between /ə/ and /o/.

#### 3.3.4. *Interim summary*

The RTR contrast-based two-height vowel system in Middle Korean has changed into the labial contrast-based three-height vowel system in Early Modern Korean. This change was triggered by the so-called first merger of /ʌ/ motivated by its phonetic overlap with /ə/ and the status of RTR contrast as the lowest contrastive feature in the contrastive hierarchy [coronal] > [low] > [labial] > [RTR]. This change, although restricted in position, triggered the collapse of vowel harmony with the loss of RTR contrast and, consequently, the emergence of the new vowel system by introducing a new contrastive hierarchy with a new height feature by means of fission of a single height feature into two: [coronal] > [low] > [high] > [labial]. The creation of new front vowels, the second merger of /ʌ/, labialization, and anti-labialization took place under this newly-established contrastive hierarchy. After all these changes, we have the following vowel system.

(44) The EModK vowel system in the 19<sup>th</sup> c.: [coronal] > [high] ≈ [low] > [labial]

[cor]		[labial]
i	i̠	u [high]
e	ə	o
ɛ	a	[low]

### 3.4. Vowel contrast in Contemporary Korean

This section is an extension of the contrastivist analysis of the vowel systems in Middle and Early Modern Korean to the vowel systems of the modern dialects of Korean. I will show that the contrastive hierarchy theory, as it successfully accounts for the main development from Middle Korean to Early Modern Korean, explains the development into vowel systems of Contemporary Korean<sup>34</sup> dialects in a principled manner.

#### 3.4.1. Overview

##### 3.4.1.1. The two major directions

According to Kwak (2003), there are two major directional tendencies found in the development of modern Korean vowel systems: North Korean dialects are changing into a rather vertical “3|3” system as exemplified in Northwest Korean (45)a, whereas South Korean dialects are changing into a rather horizontal “2|2-2” system as exemplified in Southeast Korean (45)b.

---

<sup>34</sup> According to K.-M. Lee’s (1972a) periodization, Contemporary Korean is the 20th century Korean. Similarly but more precisely, Kwak (2003, p. 60) uses the term to refer to the Korean language from the modern enlightening period (1894-1910) of Late Yi Dynasty to present.

(45) The two directions in the development of modern dialects (Kwak, 2003)

- a. Northwest Korean: 3|3 system      b. Southeast Korean: 2|2-2 system<sup>35</sup>

i	ㅏ u	i	ㅡ i	ㅓ u
ㅓ e	ㅗ o~ɔ	ㅓ ε	ㅓ a	ㅗ o
ㅓ ε	ㅓ a			

Other dialects are in the middle of changing into one or the other, with the observed tendency that North Korean dialects follow the path of Northwest Korean, an extreme case on one end, and South Korean dialects follow the path of Southeast Korean, another extreme case on the other end (Kwak, 2003).

If we assume modern dialects share the Early Modern Korean vowel system in (30)b as their predecessor, the changes into (45)a and (45)b can be viewed as the loss of labial contrast and the decrease of the number of height contrasts, respectively.

#### 3.4.1.2. The status of Early Modern Korean as common predecessor of modern dialects

The vowel system of Early Modern Korean in (30)b can be understood as the common predecessor of dialects of Contemporary Korean. Northwest Korean and Yukcin Korean had a 8-vowel system identical to (30)b. Northeast, Southeast, Southwest, and Central Korean seem to have had a 10-vowel system with two more vowels (front rounded vowel /y/ and /ø/) developed from (30)b, although there are variations with respect to the presence and absence of the new front rounded vowels /y/ and /ø/. Jeju Korean had a symmetrical 12-vowel system with additional /ɔ/ (the reflex of /ʌ/) and

---

<sup>35</sup> The vowel /ㅡ i/ and /ㅓ ε/ in Southeast Korean is often represented by /ɘ/ and /E/, which I do not adopt in this dissertation.

its fronted counterpart /œ/. The following discussion is mainly based on Kwak's (2003) generalizations. See Kwak (2003) and references therein for further details.

### 3.4.2. Contrastive hierarchy approach to the two major directions

If all the dialects in 19<sup>th</sup> century share a vowel system similar to that of Early Modern Korean in (30)b, why is it that we have two different directional tendencies? Why is it that the North Korean dialects lose their labial contrast, whereas the South Korean dialects lose the three-way height distinction?

The contrastivist approach adopted here ascribes the difference in the directional tendency to the difference in the contrastive hierarchy as diagrammed in (46):

(46) Contrastive hierarchies for Northwest and Southeast Korean

a. Northwest Korean:

[cor] > [low] > [hi] > ~~[lab]~~

[cor]		u	[hi]
i		o	
ε		a	[low]

b. Southeast Korean:

[cor] > [low] > [lab] > ~~[hi]~~

[cor]		i	u
ε		a	o
			[low]

Even though they seem to have shared a similar vowel system (30)b in the Early Modern Korean era, it is possible that each vowel system has slightly different contrastive hierarchy from the other.

All North Korean dialects including Northwest Korean seem to retain the EModK contrastive hierarchy [coronal] > [low] > [high] > [labial]. However, the difference between EModK and modern North Korean dialects lies in the extent to which the labial neutralization applies. Recall that in EModK the labial neutralization was

applied only to the contrast between /ʌ/ (= /ɔ/) and /a/ (that is, the second merger of /ʌ/). Now it is being applied across-the-board. The most advanced case in this direction, Northwest Korean, thus lost the contrastive status of [labial] as a result of the mergers between /i/ and /u/ as well as between /ə/ and /o/ (these mergers probably started in the late 20<sup>th</sup> century), in addition to the second merger of /ʌ/ (between /a/ and /ɔ/) which occurred much earlier in the 18<sup>th</sup> century. This is shown in (46)a above where the feature [labial] became non-contrastive (redundant) for /u/ and /o/, although they are phonetically rounded in all likelihood. This redundant status of [labial] is supported by the existence of non-labial allophones of /u/ ([ʉ~ɯ~u]) and /o/ ([ɔ~ɔ̃~ʌ]) in this dialect (Kwak 2003, p. 66).

By contrast, South Korean dialect is characterized by the loss of three-way height contrast (to varying degrees). The most advanced case in this direction is Southeast Korean which has already finished the complete loss of a height contrast. As a result, Southeast Korean has a two-height vowel system as shown in (46)b above. In North Kyongsang Korean, for instance, /e/ merged with /i/<sup>36</sup> and /ə/ with /i/, respectively (M.-O. Choi, 1982, pp. 36–37; Kwak, 2003, p. 80, fn. 26). Notice that both merger patterns involve the height feature [high]. If the hypothesis of *Minimal Contrast Principle* in §**Error! Reference source not found.** is viable, it should follow that [high] must be ranked at the bottom of the hierarchy, thus, [labial] > [high] rather than [high] > [labial]. This must have been achieved,<sup>37</sup> by means of a promotion of [labial],<sup>37</sup> sometime between EModK and modern South Korean.

---

<sup>36</sup> South Kyongsang Korean has a slightly different merger pattern, namely a merger between /e/ and /ɛ/. This adds a complication to a Minimal Contrast-based analysis, since the merger between /e/ and /ɛ/ involves [low] whereas the merger between /i/ and /ə/ involves [high]. I separate these two merger patterns in South Kyongsang Korean and assume that the /e/-/ɛ/ merger took place in the early 20<sup>th</sup> century under the hierarchy [coronal] > [high] > [low] > [labial] and the /i/-/ə/ merger in the late 20<sup>th</sup> century under [coronal] > [low] > [labial] > [high] (changed via a “two-step” demotion of [high]).

<sup>37</sup> A demotion of [high] would give rise to the same result, although it is difficult to conjecture a

An interesting fact regarding the status of Southeast Korean is that it seems to be losing its position as the most innovative dialect in this direction: it is reported that speakers in younger generation have a 7-vowel system where /i/ and /ə/ are distinct (Kwak 2003, p. 81). This emerging vowel system is identical (at least inventorially) to that of Central Korean and can be thought of as being standardized by education, mass media, etc. This is an example that social factors distort the natural course of language changes.

### 3.4.3. *Central Korean*

In the development of the modern Central dialect, it first retained the Early Modern Korean contrastive hierarchy [coronal] > [low] > [high] > [labial]. The mid vowel raising in the late 19<sup>th</sup> century (P.-G. Lee, 1970; Kwak, 2003, pp. 77-79) is supposed to have taken place under this hierarchy.

(47) Mid vowel raising in the late 19<sup>th</sup> century (Kwak 2003, p. 78)<sup>38</sup>

a.	i:	i:	u:
	↑	↑	↑
	e:	ə:	o:
	ɛ:	a:	

b. Examples

e: > i:     /se:saŋ/ > /si:saŋ/ ‘world’, /ce:sa/ > /ci:sa/ ‘a religious service’,  
                   /kje:/ > /ki:/ (/ci:/) ‘credit union; fraternity’

---

possible cause even pretheoretically. On the other hand, the promotion of [labial] may have occurred as a counteraction to the second merger of /ʌ/ in EModK (and the overall loss of [labial] in North Korean. As we will see later, the promotion of [labial] is also assumed to have occurred in Jeju Korean (§3.4.4).  
<sup>38</sup> Note the remarkable similarity between this vowel raising and the aforementioned merger patterns in North Kyengsang Korean, although vowel length is irrelevant to the latter .

- ə: > i:     /ə:psta/ > /i:psta/ ‘not exist’, /pə:lta/ > (/pɪ:lta/) > /pu:lta/ ‘earn’  
                   /sʰə:lta/ > /sʰi:lta/ ‘chop; dice’
- o: > u:     /to:n/ > /tu:n/ ‘money’, /oi/ > /ui/ ‘cucumber’  
                   /ho:rɛŋi/ > /hu:rɛŋi/ ‘tiger’, /cho:ŋgak/ > /chu:ŋgak/ ‘bachelor’

Mid vowel raising is found mainly in the speech of older speakers and usually limited to long vowels in initial syllables, although it is sometimes found in the speech of younger generations and/or in non-initial syllables. Since the raising is limited to non-low vowels, it can be viewed as evidence for the relative hierarchy between the two height feature, i.e., [low] > [high].

There is an inventorial difference between EModK and Central Korean: Contemporary Central Korean experienced the creation of front non-low rounded vowels, /y/ and /ø/ supposedly in the 20<sup>th</sup> century (K.-M. Lee 1972a, p. 228). According to Kwak (2003 and references therein), those dialects which underwent this inventorial change include Central, Southeast, Southwest, and Northeast Korean, although the details are not exactly the same. It must be noted that Northwest Korean, which (I argued) lost the feature [labial] completely, does not belong to this group.

These vowels are created from the off-glide (falling) diphthongs, /uj/ and /oj/, respectively.

(48) Creation of /y/ and /ø/ from /u/ - /i/ and /o/ - /i/

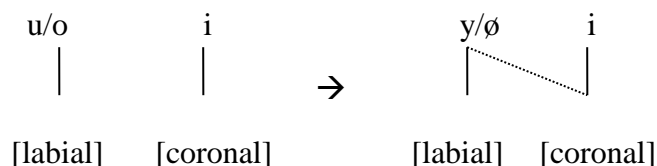

Depending on the context, /y/ and /ø/ can be pronounced as diphthongs [wi] and [we], respectively. Speakers in younger generation tend to pronounce them as diphthongs regardless of the context.<sup>39</sup> Thus, they seem to have undergone the following changes.

(49) off-glide (falling) diphthong > monophthong > on-glide (rising) diphthong

/uj/	/y/	/wi/
/oj/	/ø/	/we/

Like the mid vowel raising, the creation of non-low front round vowels can also be viewed as evidence for the relative hierarchy [low] > [high] since the new round vowels are limited to non-low vowels. Based on these facts, I propose the following vowel system for Central Korean in early 20<sup>th</sup> century.

(50) Central Korean in the early 20<sup>th</sup> c.: [coronal] > [low] > [high] > [labial]

[coronal]		
i	[labial]	i
e	(y)	u [high]
ε	(ø)	ə
ε		a [low]

Speakers in younger generation, however, do not distinguish /e/ and /ε/. This new merger pattern seems to be reigning in all subdialects of Central Korean. To explain

---

<sup>39</sup> [y] and [ø] were allophonically distributed after alveolars and palatals in 19<sup>th</sup> century (P.-G. Lee 1970, pp. 378-379). The status of these sounds as a phoneme is controversial. Refer to Kwak (2003, pp. 74-76) and references therein for details.



this merger pattern, I assume the following contrastive hierarchy for younger generation's vowel system so that /e/ and /ɛ/ form a minimal contrast:

(51) Central Korean in the late 20<sup>th</sup> c.: [coronal] > [high] > [low] > [labial]

[cor]			[lab]	
i		i	u	[high]
e		ə	o	
ɛ		a		[low]

The change from (50) to (51), i.e., the “inversion” between [low] and [high], can equally be viewed as the result of either a *demotion* of [low] or a *promotion* of [high].

#### 3.4.4. Jeju (Cheju) Korean

Modern Jeju Korean, the language of Jeju Island off the southern end of the Korean peninsula, is particularly interesting because it retains the Middle Korean vowel /ʌ/ (reanalyzed as /ɔ/) and the newly-created front vowels /e/ and /ɛ/. It does not seem to follow the typical directions of the other dialects.

The vowel system in the early 20<sup>th</sup> century was symmetrical as shown below, although front rounded vowels are no longer phonemic:

(52) The vowel system of Jeju Korean in early 20<sup>th</sup> century (S.-C. Jeong, 1988, p. 67)

		[-back]		[+back]	
		[-round]	[+round]	[-round]	[+round]
[+high]		i	(ɾ) y	—	i u
[-high, -low]	ɳ	e	(ɳ) ø	ɳ	ə o

[+low]                      ㅏ ε              (·) œ              ㅓ a              · ㅓ (= ㅓ)

Of particular interest here is the existence of the low front rounded vowel /œ/. This vowel, which is not found in any other modern dialects, is due to the retention of /ʌ/ (as /ɔ/) at the time of the creation of front rounded vowels. The formal mechanism of the creation of /œ/ is not different from that of /y/ and /ø/ in (37): the feature [coronal] is contributed by /i/ and the feature [labial] and [low] are contributed by /ʌ/.

(53) Creation of /œ/ from /ʌ i/ sequence

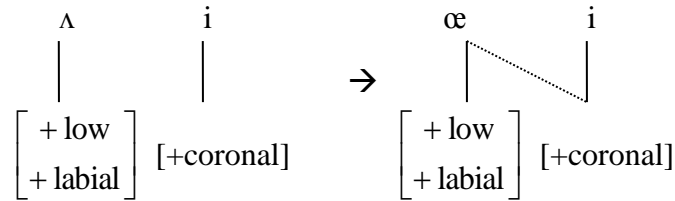

This is direct evidence for the contrastive specification of the feature [labial] and [low] for /ʌ/ (thus, supporting the view that it is indeed /ɔ/) in Modern Jeju Korean.<sup>40</sup> This, in turn, indirectly supports the claim that Early Modern Korean /ʌ/ after the first merger was low rounded.

The vowel system of Jeju is currently changing from 9- to 7-vowel system, as illustrated in (54)a and (54)b (T. Cho et al., 2000; S.-C. Jeong, 1988, 1995; W.-J. Kim, 1963). According to S.-C. Jeong (1995), the 9-vowel system is found in the dialect of

<sup>40</sup> There is a body of phonetic studies of /ʌ/ in Jeju Korean. First of all, the acoustic studies of the backness and height by measurement of the F1 and F2 (or F2-F1) frequency values (T. Cho, Jun, Jung, & Ladefoged, 2000; Hyun, 1992; H.-K. Kim, 1980; W. Kim, 2005) or midsagittal X-ray tracing of the vocal tract configuration (Hyun, 1992) clearly shows that it is a low back vowel. As for its roundedness, Hyun's (1992) photographic analysis of the lip shapes shows that the vowel /ʌ/ is rounded. Also, it seems that most native Jeju Korean scholars (Hyeon, 1962, 1964; Hyun, 1992; W. Kim, 2005; cf. S.-C. Jeong, 1988) have the common intuition that the vowel /ʌ/ (= /ɔ/) is rounded.

the older generation, and the 7-vowel system is found in the dialect of the younger generation.<sup>41</sup>

(54) The ongoing change of vowel system in Jeju (S.-C. Jeong, 1995)

a. 9 vowel system

i	— i	⌊ u
ㅓ e	ㅕ ə	ㅗ o
ㅚ ε	ㅛ a	· ㅜ (=ɔ)

b. 7 vowel system

i	— i	⌊ u
ㅓ e	ㅕ ə	ㅗ o
	ㅛ a	

The above observation is supported by the acoustic comparison between the vowel system in 1960-70s (H.-K. Kim, 1980) and the vowel system in 2000s (T. Cho et al., 2000).

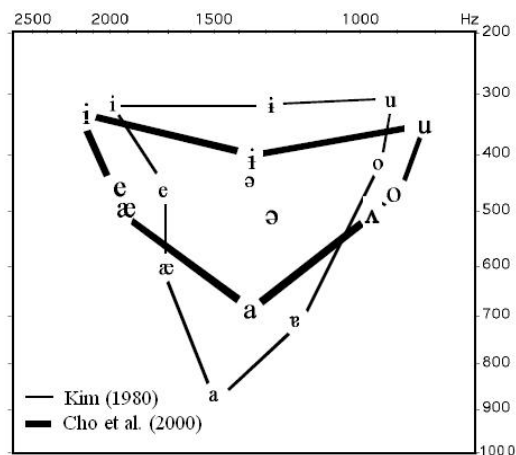

Figure 5. Comparison between Jeju vowel systems at two time frames (T. Cho et al., 2000). The data of H.-K. Kim (1980) were collected in 1969.

<sup>41</sup> A social factor also plays a role. That is, the mergers spread from the urban to the rural area (T. Cho et al., 2000).

In the above figure, we find two merger processes: the merger of /e/ and /ɛ/ (= /æ/), and the merger of /o/ and /ʌ/ (the latter is represented by /ɒ/ in H.-K. Kim, 1980). The two mergers share the same characteristics, namely the loss of low contrast. Thus, as T. Cho et al. (2000) points out, the “four” vowel height contrast is reduced to the “three” vowel height contrast as a result, at the phonetic level.

The direction of these ongoing mergers in Jeju Korean implies the contrastive hierarchy [coronal] > [high] > [labial] > [low]. This hierarchy explains why the Jeju Korean vowel /ʌ/ merges with /o/, not /a/, in spite of its being closer to /a/<sup>42</sup>: /ʌ/ contrasts with its non-low counterpart /o/, not with its labial counterpart /a/ given the relative hierarchy [labial] > [low].

(55) The contrastive hierarchy of Jeju Korean: [coronal] > [high] > [labial] > [low]

[cor]		[lab]	
i		i	u [high]
e		ə	o
ɛ		a	ʌ (=ɒ) [low]

The change from Early Modern Korean to Jeju Korean may be viewed as having taken place in the following steps:<sup>43</sup>

(56) Contrastive hierarchy change in Jeju Korean

<sup>42</sup> Compare the distance between /ʌ/ and /o/ and the distance between /ʌ/ (= /ɒ/) and /a/ in H.-K. Kim 1980.

<sup>43</sup> It is also conceivable that, more parsimoniously, Jeju Korean inherited the hierarchy [coronal] > [high] > [low] > [labial] from Early Modern Korean since [high] > [low] is a legitimate result of the assumed fission of [low]. Then, the change would be comprised of the promotion of [labial] only.

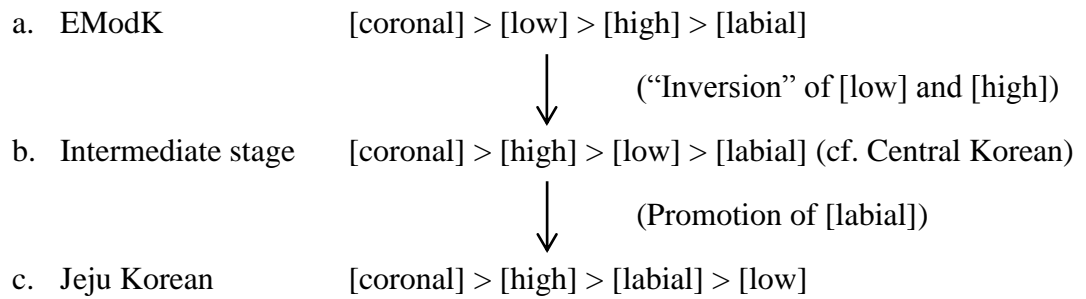

### 3.5. The end of the Korean vowel shift controversy

Since the 1960s the Korean Vowel Shift hypothesis (the KVS henceforth; W.-J. Kim, 1963 et seq. K.-M. Lee, 1964 et seq.) has been one of the most entrenched views in the Korean historical phonology. Although it has been pointed out that the hypothesis is untenable since it faces a number of theoretical and empirical problems (see Hattori, 1975; S. Kang, 1980; J. Kim, 1993; Martin, 2000; S.-S. Oh, 1998; Vovin, 2000 among others), the KVS is still widely accepted by most Korean linguists (Ahn, 2002; Kim-Renaud, 2008; K.-M. Lee & Ramsey, 2011 among others) and the primary evidence for the hypothesis, i.e., Mongolian loanwords (K.-M. Lee, 1964), has yet to be fully refuted.

This section aims to end the controversy over the KVS by demonstrating that the Mongolian loanwords, which have been claimed to be the primary evidence, do not support the hypothesis because the Old Mongolian vowel system is not based on palatal contrast but based on tongue root contrast, as we have seen in §0. The result will be a simpler but more elegant account for both Korean and Mongolic vocalic history.

#### 3.5.1. *The Korean Vowel Shift hypothesis*

The KVS holds that the vowel harmony pattern with the harmonic pairing of /i/~/Λ/, /u/~/o/, and /ə/~/a/ in Late Middle Korean (57)c is the “historical vestige of earlier

ideal palatal harmony” (C.-W. Kim, 1978), more specifically, the reflection of the palatal (front vs. back) contrast in Old Korean (57)a.

(57) The Korean Vowel Shift Hypothesis (K.-M. Lee 1972)

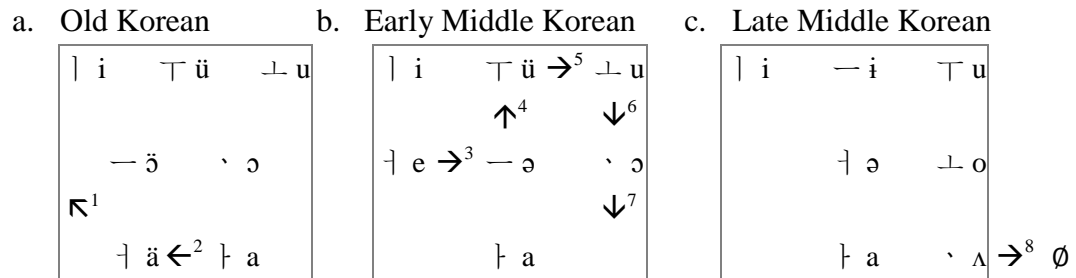

These two stages are mediated by a two-step chain shift: a pull chain by which \*ä was raised and fronted (Step 1) and \*a shifted to a central position (Step 2) resulting in the hypothesized Early Middle Korean system (1b), and a push chain triggered by a backward movement of \*e (Step 3) and subsequently followed by an upward movement of \*ə (Step 4), a backward movement of \*ü (Step 5), and downward movements of \*u (Step 6) and \*ɔ (Step 7). The lowered vowel \*ɔ became \*ʌ and disappeared later through what is known as the “two-step loss of ‘alay a’” (Step 8).

The primary documentary evidence for the proposed vowel shift comes from Mongolian loanwords found mainly in *Penyek pak thongsa* 翻譯朴通事 (1517) and *Hwunmong cahoy* 訓蒙字會 (1527). Here are some representative examples taken from K.-M. Lee (1964) with slight modification.

(58) Examples of Mongolian loanwords (K.-M. Lee, 1964; see also K.-M. Lee & Ramsey, 2011, pp. 96–97)

Old Mongolian <sup>44</sup>	Late Middle Korean	Gloss
a. <u>k</u> ü <u>r</u> eng	<u>k</u> ur <u>ə</u> ŋ	‘dark brown’
b. <u>k</u> ö <u>g</u> s <u>i</u> n	<u>k</u> w <u>ə</u> kc <u>i</u> n	‘old wild falcon’
c. bay <u>u</u> da <u>l</u>	pa <u>o</u> ta <u>l</u>	‘military camp’
d. <u>o</u> lang	<u>o</u> raŋ	‘belly-band, girth’

The correspondence between Old Mongolian and (Late) Middle Korean vowels is summarized in the table below.

(59) MK transcription of the 13<sup>th</sup> century Mongolian vowels (K.-M. Lee, 1964)

OM	i	e	a	ü	ö	u	o
MK	ㅣ	ㅓ	ㅑ	ㅕ	ㅛ	ㅜ	

The critical question for K.-M. Lee is, “why was the Korean vowel <ㅕ> equated to a *front* [emphasis added] vowel” \*ü in Mongolian (K.-M. Lee & Ramsey 2011, p. 94)? His conclusion is that <ㅕ> was originally a front vowel (more precisely a central vowel), but moved backward later as indicated in Step 5. Similarly, he also regarded <ㅓ> in Early Middle Korean as a front vowel that later became centralized in Late Middle Korean as in Step 3. The MK transcription of OM \*u into <ㅜ> is also crucial. Together with the transcription of OM \*ü into MK <ㅕ>, this may indicate that, if the contrast between <ü> and <u> in OM were palatal, then the corresponding contrast between <ㅕ> and <ㅜ> would be palatal too.

---

<sup>44</sup> Although K.-M. Lee (1964) uses the term *Middle Mongolian* (à la Poppe 1955), I will use the term *Old Mongolian* as previously defined as “the immediate ancestor language that can be reconstructed from documents written in four different scripts: Uigurs, Chinese, Arabic, and ’Phags-pa in the 13th to 14th centuries” (Svantesson et al. 2005, p. 98).

(60) OM ü : u = MK ㅓ : ㅜ

K.-M. Lee also points out that the rendering of OM \*o as <ㅓ> may be because <ㅓ> was the only rounded back vowel in MK.

It is also claimed that a secondary piece of evidence (especially for Step 4 and 7) is found in Chinese transcriptions of Koryeo lexical items in *Jīlín lèishì* [Kyerim yusa] 鷄林類事 (‘Assorted matters of Jīlín’ 1103)<sup>45</sup> compiled by Sūn Mù 孫穆, an envoy of the Song Dynasty (K.-M. Lee & Ramsey 2011, pp. 94-95), although this claimed evidence was soon confronted with serious rebuttals.<sup>46</sup>

(61) *Jīlín lèishì* (K.-M. Lee & Ramsey 2011, pp. 94-95)

a. LMK /ʌ/ < EMK \*/ɔ/

河屯 ‘one’ (LMK \*hʌtʌn \* ), 末 ‘horse’ (LMK mʌl 𪛗)

Yuan-period Chinese: 河 \*xɔ 末 \*mɔ

b. LMK /i/ < EMK \*/ə/

黑根 ‘big’ (LMK khin 𪛗 < \*hikin)

Yuan-period Chinese: 黑 \*xəj 根 \*kən

<sup>45</sup> *Jīlín lèishì* includes about 350 Korean words and phrases. The basic format and interpretation is as follows:

e.g., 天<sub>1</sub>曰<sub>2</sub>漢<sub>3</sub>捺<sub>3</sub>  
 “sky<sub>1</sub> is called<sub>2</sub> ‘[the Korean word] (in Chinese pronunciation)’<sub>3</sub> (LMK 하늘)

<sup>46</sup> However, more thorough investigations (S. Kang, 1980; C. Park, 2000; H.-J. Park, 2001) suggest that K.-M. Lee’s interpretation may be incorrect. K.-M. Lee’s interpretation of the Korean-Chinese correspondences is based on the pronunciation of Chinese in Yuan-period (1271-1368), not Song-period (960-1279), simply because the latter was unknown at the time of the establishment of the KVS. According to S. Kang (1980), who reconstructed EMK (12c) based on the Song-Chinese pronunciations (12c) estimated by Hirayama (1967), /ʌ/ corresponds to \*[ii], \*[i], \*[a] (cf. 河 \*[ha], p. 208, #19), \*[iuə], \*[ə], \*[uə] (cf. 屯 \*[tʰuən], p. 208, #19), and \*[ua] (cf. 末 \*[muat], p. 209, #98), and /i/ corresponds to \*[ii], \*[ə] (cf. 黑根 \*[hək-kən], p. 214, #348), \*[iə], \*[uə], \*[iuə], and \*[a], as summarized in H.-J. Park (2001).



There have been many criticisms against the KVS from both empirical and theoretical points of view. Above all, the proposed palatal system in Old and Early Middle Korean is contradictory to what can be reconstructed by the comparative method. Since there are no known modern reflexes of front-back vowel contrast, it is unlikely that any earlier system had the assumed palatal system (Hattori 1975).

(62) The comparative method applied to the modern dialects of Korean

a. Vowel correspondence in initial syllable (based on Kwak 2003)

Middle Korean	ㅣ	ㅑ	ㅓ	ㅡ	ㅜ	ㅗ	ㅛ
Northwest	i	o [ɔ]	a	u	a	u	o [ɔ]
Northeast	i	ə	a	i	a	u	o
Central	i	ə	a	i	a	u	o
Southeast	i	i	a	i	a	u	o
Southwest	i	ə	a	i	a	u	o
Jeju	i	ə	a	i	ɔ	u	o

b. Reconstruction \*i \*ə \*a \*i \*ɔ \*u \*o

Second, under the KVS, the descriptions of vowels given in *Hwunmin jengum hayryey* 訓民正音解例 (1446) are not well understood. Especially, the descriptive terms *chwuk* 縮 ‘retraction’ and *sim/chen* 深/淺 ‘deep/shallow’ remain unexplained. There is no known correlation between the proposed palatal contrast and the aforementioned articulatory and auditory descriptions (K.-M. Lee & Ramsey 2011: 156; see also Hattori 1975; J Kim 1993).

Third, the KVS calls for an undesirable “discrepancy between the vowel harmony and the vowel system” (K.-M. Lee, 1968, as cited in J. Kim 1993, p. 34) whereby the LMK vowel harmony pattern operates on the vowel contrast in Old Korean.

Fourth, the KVS has been criticized for its peculiarities such as overcomplexity (J. Kim, 1993), unnaturalness (S.-S. Oh, 1998), and unattestedness (Labov, 1994). For instance, it is pointed out that the proposed KVS violates the Labovian principles of vowel shifting (Labov, 1994, p. 138).

(63) The Labovian principles of vowel shifting (Labov, 1994, p. 116)

- a. PRINCIPLE I        In chain shifts, long vowels rise.
- b. PRINCIPLE II       In chain shifts, short vowels fall.
- c. PRINCIPLE II<sub>A</sub>     In chain shifts, the nuclei of upgliding diphthongs fall.
- d. PRINCIPLE III      In chain shifts, back vowels move to the front.

Fifth, the KVS makes a number of wrong predictions: for instance, Hattori (1978, as cited in J. Kim, 1993) points out that given the phonetic value of < ㆍ > as /ɔ/ in Early Modern Korean assumed by K.-M. Lee, Old Mongolian *ɔlang* ‘belly-band, girth’ (58)d would have been transcribed in Middle Korean as < ㅁ 랑 *ɔlang* > /ɔlaŋ/ instead of the attested < 오 랑 *wɔlang* > /ɔlaŋ/.<sup>47</sup> We also have an interesting example which have not been discussed in any previous literature: < 고 개 *kwotɔlkay* > /kutɔlkaj/ which corresponds to OM *quduɾya* ‘crupper’ (K.-M. Lee, 1964, p. 191). K.-M. Lee’s hypothesis incorrectly predicts < 고 돌 개 *kwotwɔlkay* > /kutɔlkaj/.

Also, as Martin (2000, p. 26) points out, the KVS predicts that the people of *Kolye* 高麗 would have called their nation /kulje/, which is highly unlikely. The Korean-

---

<sup>47</sup> The phonological transcription in “/ /” here follows K.-M. Lee’s hypothesis in (57)b.

Japanese vowel correspondences established by Frellesvig & Whitman (2008) is incompatible with the predictions made by the KVS as well.

Sixth, the insufficiency and inconsistency of the documentary evidence has also been pointed out (Martin, 2000; Vovin, 2000). For example, in *Monge nokeltay* 蒙語老乞大 compiled in 1741, Mongolian <ü> was still transcribed into Korean <ㅓ>, which is hard to explain because the vowel shift should have been long completed then (Vovin, 2000, p. 66).

Finally, the KVS is incompatible with Ito's reconstruction of Old Korean (roughly in the 9<sup>th</sup> century) based on the Sino-Korean phonology (Ito, 2007, p. 267):

(64) Old Korean vowel system reconstructed by Ito (Ito, 2007, p. 267)

i [i]	ɨ [ɨ]	u [u]
ə [ɛ]	ʌ [ə]	o [o]
	a [a]	

Ito argues that, considering the above vowel qualities, a palatal harmony analysis is untenable for Old Korean at the time<sup>48</sup> of the borrowing of Sino-Korean morphemes. To be compatible with Ito's view, the KVS hypothesis would require another vowel shift to have occurred sometime between Old Korean and Early Middle Korean in the counter-direction.

All these questions and criticisms, however, remain unanswered even in the most recent published work by the leading advocate of the hypothesis (K.-M. Lee & Ramsey 2011).

---

<sup>48</sup> According to Ito (2007), the source of Sino-Korean morphemes is in all likelihood the Chang'an dialect in the Tang dynasty. See also Kōno (1968).

Hattori (1975) and J. Kim (1993, p. 50) pointed out that it would be more desirable to reconstruct the Old Mongolian vowels based on the reconstructed Middle Korean vowels, not vice versa, since the latter is relatively well-established (J. Kim, 1993, p. 50). This is what I actually attempted in §2.3.2.3 and the result was consistent with the reconstructed OM vowels based on the comparative methods.<sup>49</sup>

Note that what constitutes the basic premise of Lee's original claim is the long-held assumption that Old Mongolian had a vowel system based on palatal (front vs. back) contrast. This assumption, although briefly challenged by Hattori (1975) and J Kim (1993) with respect to the KVS, has been generally accepted by most Mongolists. In the previous chapter, however, I have demonstrated that Old Mongolian had an RTR rather than a palatal system. I will briefly repeat the main points below. See §0 for further detail.

### 3.5.2. *Old Mongolian: an RTR analysis*

As we have seen in Chapter 2, it has long been assumed that Old Mongolian (or any pre-modern Mongolic) had the following vowel system based on the front vs. back contrast.

#### (65) Pre-modern Mongolic vowel systems

<i> i	<ü> y	<u> u
	<ö> ø	<o> o
	<e> e	<a> a

---

<sup>49</sup> Note that, in his 1964 article where he proposed the earliest version of the KVS, K.-M. Lee himself did analyze Old Mongolian based on Middle Korean with regard to consonants and tones.

However, the comparative methods applied to modern Mongolic varieties (66) indicates another possibility.

(66) Vowel correspondence (modified from Svantesson et al. 2005, p. 180)

Khalkha	a	ɔ	ʊ	e	o	u	i
Chakhar	a	ɔ	ʊ	ə	o	u	i, ɪ
Baarin	a	ɔ	ʊ	ə	o	u	i
Shira Yugur	a	ɔ	ʊ	e	ø	u	ə
Kangjia	a	ʊ, ɔ	ʊ	e	o, u	u	i
Monguor	a	o	u, o	i, e	o, u	u	i
Bonan	a	o	u	ə	o	u	i, ʉ
Santa	a	o	u	ie, ə	o	u	i
Moghol	a, o	o	u	e	o	u	i
Buriat	a	ɔ	ʊ	e	u	u	i
Khamnigan	a	ɔ	ʊ	e	u	u	i
Dagur	a	ɔ	ɔ, wa	ə	u	u	i
Kalmyk	a	o	u	e	ø	y	i

For example, when we apply the “majority-wins” principle, it yields the following result as the reconstructed OM vowels:

(67) Reconstruction of OM by the application of ‘majority-wins’ criterion

OM	*a	*ɔ	*ʊ	*e	*o	*u	*i
----	----	----	----	----	----	----	----

Considering other criteria such as “economy” and “natralness” as well, I proposed the following RTR-based vowel system for OM in the previous chapter:

(68) An RTR analysis of the OM vowel system

<i> i                      <ï> u  
                                    <u> ʊ  
                            <e> ə   <ö> o  
                            <a> a   <o> ɔ

### 3.5.3. *Mongolian loanwords revisited*

Now that we have reanalyzed the Old Mongolian vowel system as an RTR system, not a palatal system, there remain no grounds for defending K.-M. Lee's palatal analysis of Early Middle Korean.

The null hypothesis being that there was no change in the vowel system unless evidenced otherwise, I extend the synchronic analysis of Late Middle Korean (J. Kim, 1999; J.-K. Kim, 2000; J.-H. Park & Kwon, 2009, among others) to Early Middle Korean.<sup>50</sup> Note the remarkable similarity between the following EMK vowel system and the OK vowel system proposed by Ito (2007).

(69) Early Middle Korean vowel system

<ㅣ> i    <ㅡ> ɨ    <ㅓ> u  
          <ㅜ> ʌ    <ㅗ> o  
          <ㅚ> ə  
          <ㅓ> a

---

<sup>50</sup> This may have an effect of reducing the historical periods, for the proposed vowel shift has been considered to be the primary source of the demarcation between Early Middle Korean and Late Middle Korean (K.-M. Lee & Ramsey 2011, p. 78).

Under the current RTR analysis of both Old Mongolian (68) and Middle Korean (69), the vowel correspondence between the two languages shown in (59) earlier (and repeated in (70) below) receives a straightforward explanation.

(70) Vowel correspondences between Old Mongolian and Middle Korean (K.-M.

Lee 1964)

OM	i	e	a	ü	ö	u	o
MK	ㅣ	ㅓ	ㅕ	ㅗ	ㅛ	ㅜ	

How exactly is the vowel correspondence accounted for in the current analysis? Let us compare the two vowel systems.

(71) Old Mongolian and Middle Korean vowel systems (RTR-RTR analysis)

a. Old Mongolian

<i> i	<ü> u
	<u> ʊ
<hr/>	
<e> ə	<ö> ɔ
<a> a	<o> ɔ

b. Middle Korean

<ㅣ> i	<ㅡ> i	<ㅗ> u
	<ㅜ> ʌ	<ㅜ> ɔ
<hr/>		
<ㅓ> ə		
<ㅕ> a		

This “RTR-RTR” analysis predicts that OM low rounded vowels /o/ and /ɔ/ would have no corresponding vowels in MK and, thus, be transcribed with other reasonably similar vowels. Likewise, since OM does not have a high back unrounded vowel, no vowel should be transcribed as MK /i/ and /ʌ/. These predictions are all borne out.

(72) OM MK

<i>	i	i	<ㅣ>
<e>	ə	ə	<ㅓ>
<a>	a	a	<ㅏ>
<ü>	u	u	<ㅜ>
<u>	ʊ	o	<ㅝ>
<ö>	o	wə	<ㅟ>
<o>	ɔ	o	<ㅞ>

Let us compare each vowel correspondence. First of all, the Mongolic <i, e, a, ü> have the same phonetic value as the Korean <ㅣ, ㅓ, ㅏ, ㅜ>, respectively. Special attention is due to the correspondence between <ü> and <ㅜ> since this is not to be viewed as evidence for the proposed KVS any more. Next, the correspondence between OM <ö> and MK <ㅟ> (/wə/) on which the KVS does not provide any explicit explanation is also very straightforward: since there is no equivalent of OM <ö> /o/, the labial counterpart of <e> /ə/, in the MK vowel inventory, it might be the case that Middle Korean speakers/transcribers opted to add the labial glide /w/ to MK /ə/ to denote the labiality of OM <ö>. Finally, the correspondence between OM <u, o> and MK <ㅝ> is understandable as well: first, OM <u> /ʊ/ and MK <ㅝ> /o/ have the same status as the RTR counterpart to /u/ albeit their distinct phonemic symbols; second, with no direct equivalent, MK <ㅝ>, the only back rounded RTR vowel in the MK inventory, seems to be the best available match-up for OM <o> /ɔ/.

Recall that the MK transcription <ᄒᆫ ᄒᆫᆫ kwot<sup>o</sup>lkay> for OM qudurya ‘crupper’ (K.-M. Lee, 1964, p. 191). In the “RTR-RTR” analysis here, MK <ᄒᆫ ᄒᆫᆫ> is understood as /k<sup>o</sup>t<sup>o</sup>lkaj/ and OM qudurya as /qu<sup>o</sup>du<sup>o</sup>rya/.<sup>51</sup> The correspondence

<sup>51</sup> Consonant symbols are left unchanged to avoid unnecessary complications.



between MK /o/ and OM /ʊ/ in the first syllable has just been explained above; our concern here is the correspondence between MK /ʌ/ and OM /ʊ/ in the second syllable. My view is that OM /ʊ/ (and other vowels in general) in non-initial syllables tends to be reduced (cf. modern Khalkha and other Mongolic varieties), perhaps slightly delabialized due to the surrounding coronals in this specific case. MK /ʌ/, the non-labial counterpart to the high rounded RTR vowel /o/ would be a perfect match to this reduced, delabialized allophone of /ʊ/.

This correspondence is comparable to the one between Modern Mongolian RTR system (Khalkha and Chakhar) and Modern Korean RTR system observed in the perceptual experiments conducted by J. Kim (1993). Thus, it would be either the case that both languages retain the earlier RTR system or the case that both had a palatal system and shifted to an RTR system similarly. The latter scenario is rather unrealistic.

#### 3.5.4. *Summary*

The Korean Vowel Shift hypothesis relies primarily on the palatal analysis of Old Mongolian. However, I have shown that the original OM vowel system is based on RTR contrast and, thus, provides no empirical basis for the KVS. This, alongside other empirical and theoretical problems of the KVS, leads us to the conclusion that there was no vowel shift in the history of Korean.

### 3.6. **Conclusion**

This chapter provides a contrastivist account of the historical development of the vowel system in Korean. First I have shown that Middle Korean had an RTR-based vowel system. Then, I have also shown that the major changes in the Korean vowel system are best accounted for in terms of changes in the *contrastive hierarchy* of distinctive features, which are substantiated with corroborative empirical evidence.

Based mainly on the newly proposed RTR analysis of Old Mongolian vowel system presented in the previous chapter (§2.3.2), we were also able to show that there was no *Great Vowel Shift* (contra K.-M. Lee 1972; K.-M. Lee & Ramsey 2011).

## CHAPTER FOUR

### TUNGUSIC LANGUAGES

#### 4.1. Introduction

This chapter explores the vowel systems of Tungusic languages and attempts a contrastive hierarchy analysis for each of them. This line of research has been already initiated with Manchu (Dresher & Zhang, 2005; X. Zhang, 1996) and Oroqen (X. Zhang, 1996) data. Taking these as my point of departure, I will first revisit the ATR-based contrastive hierarchy analysis of Written Manchu by Dresher & Zhang (2005) and propose an RTR-based analysis, assuming [RTR] as a distinct feature that differs from [ATR]. Then, I will show that this RTR-based contrastive hierarchy analysis is also viable for all other Tungusic languages (à la J. Kim, 1989; B. Li, 1996).

##### 4.1.1. *The Tungusic languages*

Tungusic languages, also known as Manchu-Tungus or Tungus, are spoken mainly in Eastern Siberia and Manchuria. Most of the Tungusic languages are underdocumented and understudied, both historically and contemporarily. The only extant historical texts include a handful of Jurchen inscriptions from the 12<sup>th</sup> ~ 13<sup>th</sup> centuries, Chinese transcriptions of Jurchen in Ming Dynasty multilingual dictionary *Huayi yiyu* ‘Sino-Barbarian Dictionary,’ and exceptionally abundant Manchu texts from the Qing (Manchu) Dynasty (J. Kim, 1989). For other Tungusic languages, there are no such historical documents. Also, modern Tungusic languages were not well known to Western scholarship until the Russian conquest of Siberia and the establishment of the Qing (Manchu) Dynasty in the 17<sup>th</sup> century (Menges, 1978, p. 367). What is worse,

most of them are on the verge of extinction (Janhunen & Salminen, 1993; J. Kim, Kwon, et al., 2008; Moseley, 2010).

The paucity of historical written sources as well as contemporary descriptive information makes it very difficult to clarify the genetic relationship among the Tungusic varieties. According to Whaley et al. (1999, p. 292), there are three main problems: “determining the number of branches in the family, determining the distinct languages in the family, and determining the branch to which languages belong.”

Furthermore, due to a high degree of contact within the Tungusic group and with other languages such as Mongolic, Russian, Chinese, and Turkic (e.g., Yakut), many apparent shared properties may be regarded as genetic, typological, or areal.

Keeping this difficulty in mind, this chapter follows the recent classifications (J. Kim, Kwon, et al., 2008; Lewis, 2009) which divide the Tungusic languages into two branches, northern and southern branch, and then further divide the southern branch into southeast and southwest branch.

(1) Lewis (2009)

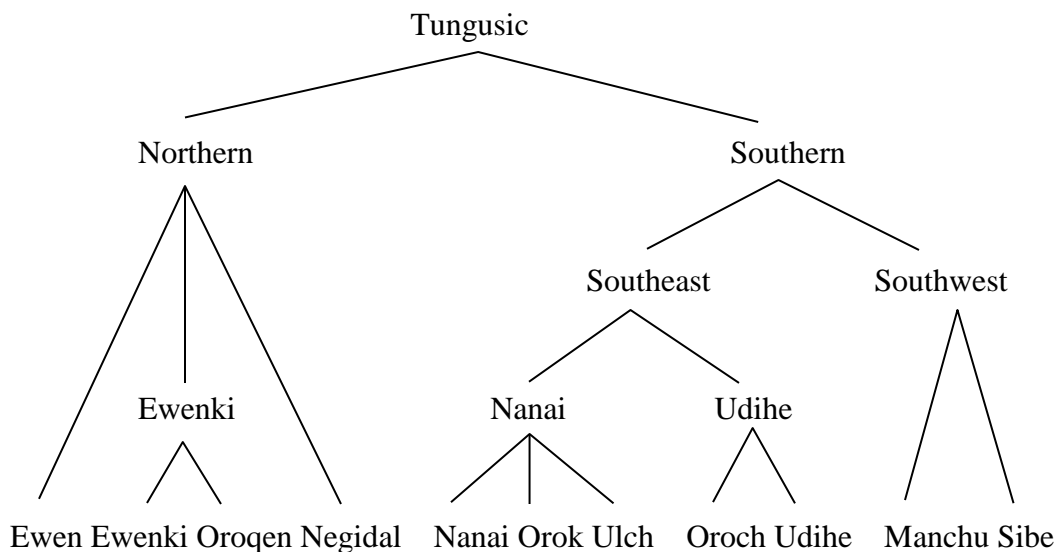

The northern branch includes Ewen, Ewenki, Oroqen, and Negidal. The southeastern branch includes Nanai, Orok, Ulch, Oroch, and Udihe. The southwestern branch includes Manchu, Sibe, and Jurchen.<sup>52</sup> (See also Avrorin, 1960; Benzing, 1956; Cincius, 1949; Comrie, 1981; Doerfer, 1978; Menges, 1968; Poppe, 1965; Sunik, 1959; Vasilevich, 1960; Vovin, 1993 for previously proposed classifications).<sup>53</sup>

#### *4.1.2. Structure of Chapter 4*

The organization of the chapter is as follows. Section 0 explores a variety of Tungusic vowel systems.

First, 4.2.1 reexamines the vowel systems of the Manchu languages in the southwest branch which have been analyzed in the contrastive hierarchy literature as ATR-based systems (X. Zhang, 1996; X. Zhang & Dresher, 2004; Dresher & Zhang, 2005) and demonstrates that Written Manchu (SW Tungusic) is better analyzed as an RTR language, rather than an ATR language.

Section 0 turns to the Southeast Tungusic languages such as Udihe, Oroch, Ulch, Uilta (Orok), and Nanai, and shows that an RTR-based contrastive hierarchy analysis is a viable option for all of these languages. Oroch will receive our particular attention since it has been analyzed within various frameworks other than the contrastive hierarchy approach such as a phonetics-based OT approach by Kaun (1995), a Stratal OT approach by Tolskaya (2008), and a Search-and-Copy model of vowel harmony in Nevins (2010). Contra those specific claims that it is impossible to give a proper CH-based treatment for Oroch (Nevins, 2010; Tolskaya, 2008), I will specifically

---

<sup>52</sup> The Jurchen language (女真語) is an extinct language, thus excluded from the tree. See Joseph (In preparation) for the relation between Manchu and Jurchen.

<sup>53</sup> Refer to Doerfer (1978), B. Li (1996), and Whaley et al. (1999) for a detailed review of the previous Tungusic classifications.

demonstrate that Oroch vowel harmony patterns can be better analyzed with the same RTR-based contrastive hierarchy as in Written Manchu. I will also show that Udihe, which has been analyzed as a height harmony language (Nikolaeva & Tolskaya, 2001), can be better analyzed under a similar approach.

Section 0 reviews the analysis of the Oroqen vowel system proposed in X. Zhang (1996) and presents the contrastive hierarchy analyses of other Northern Tungusic languages such as Ewen, Ewenki, and Negidal. Ewen, once characterized as involving pharyngealized vs. non-pharyngealized vowel contrast (Ladefoged & Maddieson, 1990; Novikova, 1960) can be viewed as an RTR language (J. Kim, 1989; B. Li, 1996, pp. 98–103), which is consistent with the RTR-based analysis of Oroqen/Ewenki (X. Zhang, 1996).

Section 4.3 briefly discusses the vocalic history of the Tungusic languages.

## **4.2. Vowel contrast in Tungusic languages**

### *4.2.1. Southwest Tungusic languages (Written/Spoken Manchu and Sibe)*

Written Manchu (also known as Literary or Classical Manchu; Seong, 1989; Ard, 1984; B. Li, 1996) is the language of the written documents of the Qing dynasty (1644-1911), whose phonetic/phonological system is reconstructed mainly from the Manchu scripts. Modern Manchu languages include Spoken Manchu and Sibe (Xibe). Spoken Manchu can be understood as a general term for all modern Manchu varieties such as the Aihui, Lalin, Alchuka, Bala, Ibuchi, Sanjiazi, and Sibe dialects (B. Li, 1996). However, Sibe, a Manchu language preserved by the descendants of the Qing dynasty military garrison in Xinjiang, is often regarded as a separate language which has experienced further developments than other modern Manchu varieties (see B. Li,

1996, pp. 36–38; X. Zhang, 1996, pp. 6–30 for more details). Drescher & Zhang (2005) view both Spoken Manchu and Sibe as descendants of the language represented by Written Manchu and present an analysis of the historical development of the vowel system from the latter to the former.

#### 4.2.1.1. Written Manchu



##### 4.2.1.1.1. *Written Manchu vowel system*

Written Manchu has the following vowel inventory:

- (2) Vowel inventory in Written Manchu (J. Kim, 1989; B. Li, 1996; X. Zhang, 1996)

i	u
	u
ə	
a	o

Since Written Manchu vowels are reconstructed based primarily on written documents, there has been controversy over the phonetic value and the phonemic status of vowels. The controversy centers around the phonetic basis of vowel harmony in Written Manchu, whether it is based on palatal contrast, height contrast, or tongue root contrast (see footnote 58 for references). However, I will not delve into this issue in this dissertation but simply accept the view that Written Manchu vowel harmony is based on tongue root contrast. Rather, of our particular interest is the phonemic

distinction between /u/ and /ʊ/ which were written in the Manchu script as  and <sup>54</sup>, and traditionally transliterated as <u> and <ū>, respectively, in Manchology.

Following Kim (1989, 1993), Li (1996), and Zhang (1996), I assume that /ʊ/ has the status of a distinct phoneme. First, there are minimal pairs which show that <u> /u/ and <ū> /ʊ/ contrast as distinct phonemes at least after dorsal consonants:

(3) Minimal pairs showing the opposition between /u/ and /ʊ/ after dorsal consonants (B. Li, 1996, p. 156)<sup>55,56</sup>

- |    |        |         |                         |
|----|--------|---------|-------------------------|
| a. | cuku-  | [ʧʊku]  | ‘to become tired’       |
|    | cukū-  | [ʧʊqʊ-] | ‘to hang down’          |
| b. | fungku | [fuŋku] | ‘towel’                 |
|    | fungkū | [fuŋqʊ] | ‘log’                   |
| c. | huju   | [xuɖʒu] | ‘trough’                |
|    | hūju   | [χʊɖʒu] | ‘Central Asiatic pearl’ |
| d. | huru   | [xuru]  | ‘shell’                 |
|    | hūru   | [χʊru]  | ‘mouth harp’            |

<sup>54</sup> Most Manchu letters have variants depending on the position of the sound within a word. The two letters introduced here are those written in “medial” positions. See G. R. Li (2000) for further details on the Manchu script.

<sup>55</sup> The Roman transliteration was added by the author here. Written Manchu examples are romanized using Norman’s system (Norman, 1978) throughout the paper. Phonemic/phonetic transcriptions are provided where necessary. The basic correspondence between the graphemes and phonemes of Written Manchu vowels is as follows:

<i>Grapheme</i>	<i>	<e>	<a>	<u>	<ū>	<o>
<i>Phoneme</i>	i	ɛ	a	u	ʊ	ɔ

Note that the macron above “u” in <ū> should not be confused with its typical use as a diacritic for a long vowel.

<sup>56</sup> See also J. Kim (1993, p. 154) for additional minimal pairs.



Note that, as in many other Altaic languages, Written Manchu shows an alternation between velars [k g x] and uvulars [q ɢ χ] depending on the quality of the tautosyllabic vowel. The vowel represented by <ū> (= /ʊ/) patterns with /a, ɔ/ in this regard: it uvularizes dorsal consonants. All the other vowels, /i, ə, u/, take velars rather than uvulars. This strongly indicates that /ʊ/ is [+RTR] (J. Kim, 1993, pp. 165–170; B. Li, 1996, pp. 155–157).

This view is supported by the fact that the modern reflex of <ū> in the Beijing and Aihui dialects of spoken Manchu is indeed realized as [ʊ].

(4) /ʊ/ in modern Beijing and Aihui Manchu (B. Li, 1996, p. 154)

a.	WM	Beijing		WM	Beijing	
	indahūn	indaχʊn	‘dog’	gūni-	ɢʊni-	‘to think’
	gūlha	(ɢ)ʊlχa	‘boot’	narhūn	narwʊn	‘thin’
b.	WM	Aihui		WM	Aihui	
	akū	aqʊ	‘not’	niyakūra-	niaqʊru-	‘to knee’
	gūlmahūn	ɢʊlmʌã	‘rabbit’	hūntahan	χʊntəɢã	‘wine cup’

It is generally assumed that the phonemic distinction between /u/ and /ʊ/ is neutralized in all contexts other than after back consonants (J. Kim, 1989, 1993; B. Li, 1996; X. Zhang, 1996; X. Zhang & Drescher, 2004). However, we find a handful of minimal or near-minimal pairs showing the contrast between <u> /u/ and <ū> /ʊ/ after non-back consonants as well, which may suggest the incompleteness of the proposed neutralization:

- (5) Minimal pairs showing the opposition between /u/ and /ʊ/ after non-back consonants (X. Zhang, 1996, p. 43)

butun	‘hibernation’	butūn	‘crock, large jar’
mungku	‘a frozen fish’	mūnggu	‘bird’s nest’
tu-	‘to hunt’	tū-	‘to hit; to beat’
tuku	‘the outside’	tūku	‘wooden mallet’
ulen	‘irrigation ditch’	ūlen	‘house’
urgen	‘length’	ūren	‘a Buddhist image’

J. Kim (1993, pp. 156–159) also argues that the vowel /ʊ/ had a wider distribution in the pre-Written Manchu period. The evidence comes from the Korean transcription of the 18<sup>th</sup> century spoken Manchu dialect documented in *Cheng hak um* 清學音.<sup>57</sup>

- (6) Comparison between Written Manchu and the Manchu dialect transcribed in Korean in *Cheng hak um* (J. Kim, 1993, pp. 156–157)

	<i>Written Manchu</i>	<i>Early Modern Korean transcription in Cheng hak um</i>	
a.	<ū>	<o>	
	gūsin	kosin	‘thirty’
	hūla-	holla	‘to read aloud, to shout’ (hūlambi)
	akū	ako, akku	‘there is not’
b.	<u>	<o>	
	buda	potahij	‘food, meal’

<sup>57</sup> *Cheng hak um* is an appendix of *Swu cwu cek lok* 愁州謫錄, a manuscript written in 1957-1959 by Yun Changhwu 尹昌屋 who was exiled to Swucwu 愁州, the present day Chongseng 鍾城, located in North Hamkyeng Province of North Korea near the Tumen River (on the border between North Korea and China). See K.-M. Lee (1973) for further bibliographic information.

	juraka	cjoraka	‘to set out on a journey’ (jurambi)
	tuwa	t <sup>h</sup> owa	‘fire’
c.	<u>	<u>	
	buce-	puc <sup>h</sup> ikə	‘to die’ (bucembi)
	turi	tul.i	‘dog’
	muke	mukkə	‘water’
d.	<o>	<o>	
	foholon	p <sup>h</sup> okoro	‘short’
	komso	koŋso	‘few’
	coko	c <sup>h</sup> okko	‘chicken’

The correspondences between Written Manchu and Early Modern Korean in (6)c (*u* :: *u*) and (6)d (*o* :: *o*) are just as expected. What is crucial are the correspondences in (6)a and (6)b. In (6)a, those vowels rendered as <ū> after uvulars in WM correspond to EMK <o>. This correspondence is consistent with our analysis of WM <ū> as /ʊ/.

However, the correspondence in (6)b between WM <u> and EMK <o> in non-post-uvular contexts is contrary to our expectation. Note first that all examples in (6)b contain one or more instances of the RTR vowel /a/, which is normally interpreted as indicating the [+RTR] status of the whole words. These facts suggest that the surface [u] in these WM words should be understood as the result of neutralization applied to the underlying /ʊ/. If the situation had been the same in the Manchu dialect documented in *Cheng hak um*, we would have found *putahij*, for WM *buda* ‘food, meal.’ But what we find in *Cheng hak um* is *potahij*. J. Kim (1993) construes this as evidence that the Manchu dialect in *Cheng hak um* retained /ʊ/ in “all” positions. It follows then that a common predecessor to Written Manchu and the Manchu dialect

reflected in *Cheng hak um* had a phonemic distinction between /u/ and /ʊ/ in “all” positions (p. 158-9).

Based on the discussion so far, I assume six vowel phonemes /i, ə, a, u, ʊ, ɔ/ in Written Manchu. Now that we have the vowel inventory, let us move on to the vowel patterns in Written Manchu.

#### 4.2.1.1.2. *Vowel patterns in Written Manchu*

Despite some debate on the range of the target consonants (Dresher & Zhang, 2005, p. 51; X. Zhang, 1996, p. 84), there is a general consensus that Written Manchu has a consonant palatalization process only triggered by /i/: e.g., *qirunga* ‘apparent,’ *mini* ‘of me’ (Odden, 1978, pp. 156, fn.2). Also, Seong (1981, pp. 110–111, 1999b, pp. 440–441, 1999c) shows examples of /i/-umlaut documented in the *Yi shi qing zi* (異施清字) section of the *Qing wen qi meng* (清文啓蒙, Primer of Manchurian, 1730) as follows:

#### (7) /i/-umlaut in *Qing wen qi meng* (Seong, 1999b, 1999c)

WM	Qing wen qi meng		
ayara	愛呀拉	aiyara	‘sour milk’
cabi	釵批	caipi [ʧaipi]	‘breast/stomach hair (of a horse)’
dehi	得衣切稀	deihi [dɛihi]	‘forty’
ekisaka	惡意切欺薩喀	eikisaka	‘quiet, still’

Vowels in a word must agree with respect to the feature [RTR]<sup>58</sup> as shown below:

---

<sup>58</sup> Recent studies all agree that Manchu vowel harmony is based on tongue root position, although they are grouped into two opposing views: an RTR analysis (J. Kim, 1989, 1993; B. Li, 1996) vs. an ATR analysis (X. Zhang, 1996; X. Zhang & Dresher, 2004). A comparison between an RTR and an ATR

(8) RTR harmony: past tense suffix -he/-ha/-ho (B. Li, 1996, p. 161)

Non-RTR stems		RTR stems	
je-ke <sup>59</sup>	‘to eat’	ala-ha	‘to tell’
gene-he	‘to go’	ara-ha	‘to make’
ku-ke	‘to swell’	kūwara-ha	‘to surround’
huthu-he	‘to tie up’	fīyakū-ha	‘to heat’

The vowel /i/ in Written Manchu is neutral and transparent to RTR harmony as illustrated in (9)a. Note that, as shown in (9)b, [u] seemingly serves as a transparent neutral vowel on the surface as well. Recall that this is due to the neutralization of /u, ʊ/ in non-post-dorsal positions.

(9) Neutral vowels (B. Li, 1996, p. 161)

Non-RTR stems		RTR stems	
a. efi-he	‘to play’	ali-ha	‘to endure’
nime-he	‘to be sick’	isa-ha	‘to come together’
b. dedu-he	‘to lie down’	yabu-ha	‘to walk’
dule-ke	‘to pass’	ura-ka	‘to echo’

In addition to RTR harmony, Written Manchu has labial harmony conditioned only by the low rounded vowel /ɔ/.<sup>60</sup> Unlike /ɔ/, the high rounded vowels /u, ʊ/ do not trigger labial harmony: e.g., *ku-ke* ‘to swell-PAST’ in (8).

---

analysis will be made later. Approaches other than tongue root analysis include palatal harmony analysis (Vago, 1973; Odden, 1978; Finer, 1981) and height harmony analysis (Ard, 1984; Hayata, 1980). However, see J. Kim (1989, 1993), B. Li (1996), X. Zhang (1996), and X. Zhang & Drescher (2004) for problems with the latter two approaches.

<sup>59</sup> Some irregular verbs take *-ke/-ka/-ko* instead of *-he/-ha/-ho* as past tense suffix.

- (10) Labial harmony: past tense suffix *-he/-ha*/ho (B. Li, 1996, p. 161)
- |          |           |             |                   |
|----------|-----------|-------------|-------------------|
| obo-ho   | ‘to wash’ | hiyotoro-ko | ‘to curve up’     |
| tokto-ho | ‘to fix’  | goihoro-ko  | ‘to lack courage’ |

Labial harmony in Written Manchu is blocked by the high vowels /i, u/ (the grapheme <u> in the following examples denotes an underlying /u/):

- (11) High vowels are opaque to labial harmony (B. Li, 1996, pp. 168&171)
- a. Suffix *-nji-* denoting ‘come to (do)’
- |             |            |             |           |
|-------------|------------|-------------|-----------|
| okdo-nji-ha | ‘to throw’ | bošo-nji-ha | ‘to urge’ |
| olo-nji-ha  | ‘to wade’  |             |           |
- b. Suffix of causative voice *-bu*
- |             |             |            |                |
|-------------|-------------|------------|----------------|
| tokto-bu-ha | ‘to decide’ | bodo-bu-ha | ‘to calculate’ |
|-------------|-------------|------------|----------------|

Note that even when labial harmony is blocked, the RTR suffix *-ha*, rather than the non-RTR suffix *-he*, is selected. This suggests that /ɔ/ in Written Manchu is an RTR vowel.

The vowel /i/ in Written Manchu is idiosyncratic in the sense that some *i*-vowel-only stems take non-RTR suffixes while others RTR suffixes.<sup>61</sup>

---

<sup>60</sup> Labial harmony is only triggered by two successive /ɔ/ vowels. A single vowel /ɔ/, whether short or long, cannot trigger harmony. This issue is beyond the scope of this paper. See Walker (2001) for a thorough discussion of this “bisyllabic trigger” condition in Tungusic labial harmony.

<sup>61</sup> J. Kim (1989, 1993) observes the same pattern and takes it as evidence for the reconstruction of two \*i’s (namely, /i/ and /ɪ/) at an earlier stage (see also Benzing, 1956, p. 21; B. Li, 1996; X. Zhang & Drescher, 2004, p. 181): the non-RTR stems originally had \*i whereas the RTR stems had \*ɪ.

- (12) “Neutral-vowel-only” stems can co-occur with either non-RTR or RTR suffixes (B. Li, 1996, p. 162)

Non-RTR stems		RTR stems	
ji-he	‘to come’	ili-ha	‘to stand’
bi-he	‘to exist’	iji-ha	‘to comb’
ulhi-he	‘to understand’	giru-ha	‘to be ashamed’
jiju-he	‘to draw a line’	curgi-ha	‘to chatter’

#### 4.2.1.1.3. *Contrastive hierarchy for Written Manchu*

The vowel patterns in Written Manchu and their implications for feature specifications can be summarized as follows:

- (13) Summary of Written Manchu vowel patterns
- a. /i/ is neutral to RTR harmony and thus lacks contrastive [-RTR]. ← (9)  
However, /i/-only stems act either as non-RTR stems or RTR stems. ← (12)
  - b. /i/ must be specified for [coronal]: /i/ triggers consonant palatalization or vowel umlaut. ← (7)
  - c. There is no evidence that /u/ and /ʊ/ bear contrastive [+labial], although they are phonetically [+labial]: they do not trigger labial harmony. ← (10)
  - d. /ɔ/ triggers labial harmony, thus bears a [+labial] specification. ← (10)
  - e. /ɔ/ triggers RTR harmony even when labial harmony is blocked. Thus, it must bear a [+RTR] specification. ← (11)
  - f. A height distinction is contrastive: (i) labial harmony is confined to low vowels and (ii) all high vowels block labial harmony. ← (11)

The contrastive hierarchy I propose for Written Manchu vowels is given in (14):

(14) Contrastive hierarchy for Written Manchu

- a. SDA: [low] > [coronal] > [RTR] > [labial]

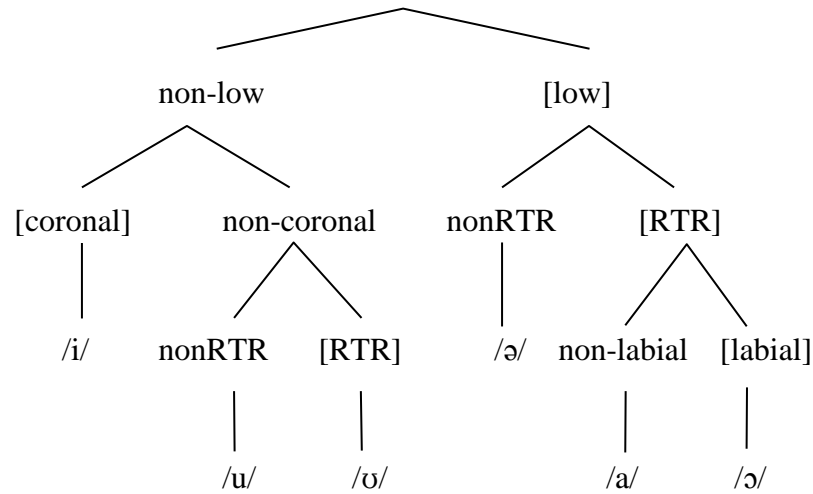

- b. Output specifications

/i/ = [-low, +cor]

/u/ = [-low, -cor, -RTR]

/ʊ/ = [-low, -cor, +RTR]

/ə/ = [+low, -RTR]

/a/ = [+low, +RTR, -lab]

/ɔ/ = [+low, +RTR, +lab]

First, a height contrast ([low]) applies to all the vowels and creates two sets of vowels, high vs. low vowels, which captures the fact that low vowels /ə, a, ɔ/ trigger and undergo labial harmony, whereas high vowels /i, u, ʊ/ block it.

The second cut is made by [coronal] which distinguishes /i/ from all other high vowels /u, ʊ/. Then, /i/ requires no further feature specifications including the [±RTR] specification, which explains its neutrality to RTR harmony. Similarly, /u/ and /ʊ/ which have already been distinguished from /i/ (and from low vowels as well) require no [+labial] specification despite their phonetic roundedness. Therefore, they cannot trigger labial harmony.



The next feature [RTR] applies to distinguish /u, ə/ and /ʊ, a, ɔ/. The last feature, [labial], identifies /ɔ/ as the only contrastively rounded vowel. Therefore, /ɔ/ receives specifications for both [ $\pm$ RTR] and [ $\pm$ labial]. Note that if, to the contrary, [labial] took scope over [RTR], /ɔ/ would first be specified as [+labial]. Then it would require no further specification for [ $\pm$ RTR], which makes the harmony pattern in (11) unexplained.

The relative ordering between the first two features, i.e., [low] > [coronal], is crucial in explaining the behavioral difference of /i/ in Tungusic and Mongolic labial harmony (van der Hulst & Smith, 1988). We have seen that in Written Manchu (and we will see later that this applies to all other Tungusic languages as well) all high vowels (/i, u, ʊ/) are opaque to labial harmony. By contrast, in Mongolic languages only /u, ʊ/ are opaque, but /i/ is transparent to labial harmony. Adopting Mester's (1986) height-stratified fusional harmony whereby labial harmony operates only on the same height tier, I ascribe the difference between Tungusic /i/ and Mongolic /i/ to the presence and absence of a contrastive height specification ([-low]) which is the result of different feature orderings: Tungusic /i/ is assigned [-low, +cor] under the hierarchy [low] > [coronal], whereas Mongolic /i/ is assigned [+cor] under a reverse ordering [coronal] > [low]. Tungusic /i/ with the contrastive [-low] specification blocks the fusion of the height tier as shown in (15). In contrast, Mongolic /i/ with no height specification is invisible to the fusional harmony process as shown in (16). See Chapter 5 for further details.

(15) Tungusic /i/ = [-low, +cor]: opaque

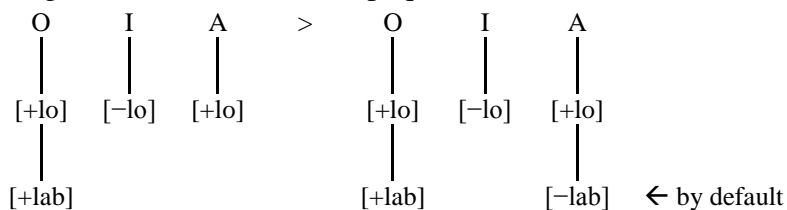

(16) Mongolic /i/ = [+cor]: transparent

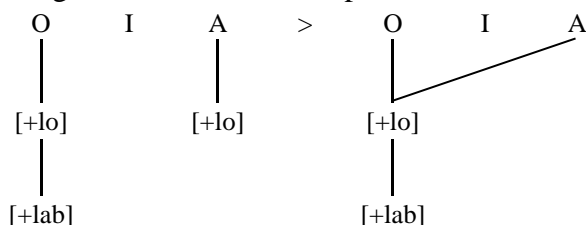

#### 4.2.1.1.4. A note on the choice between ATR vs. RTR analysis

The contrastive hierarchy analysis presented in §4.2.1.1.3 is slightly different from Dresher & Zhang's (2005) analysis of Written Manchu given below:<sup>62</sup>

(17) Contrastive hierarchy for Written Manchu (Dresher, 2009; Dresher & Zhang, 2005; see also X. Zhang, 1996)

a. SDA: [low] > [coronal] > [labial] > [ATR]

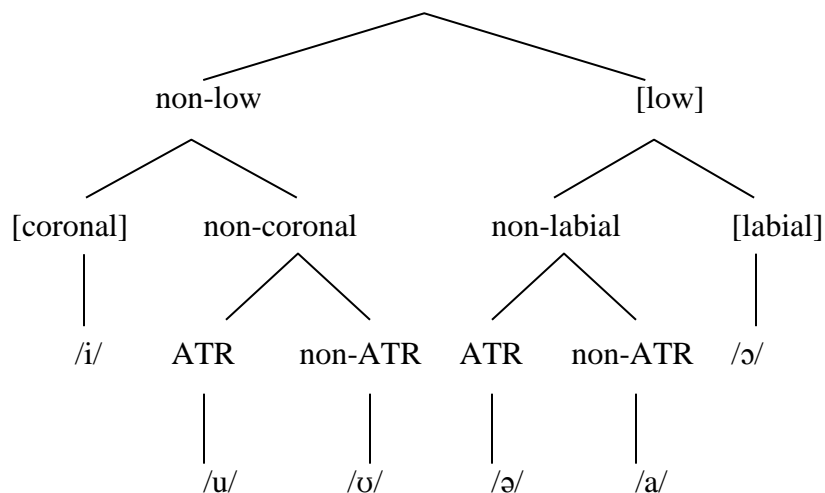

b. Output specification

/i/ = [-low, +cor]

/u/ = [-low, -cor, +ATR]

/ʊ/ = [-low, -cor, -ATR]

<sup>62</sup> Despite this minor difference, the whole dissertation has been greatly inspired and influenced by Dresher & Zhang's (2005) analysis of Written Manchu.

/ə/ = [+low, -lab, +ATR]

/a/ = [+low, -lab, -ATR]      /ɔ/ = [+low, +lab]

Compared to my analysis in (14), Drescher & Zhang's analysis has two notable differences: the partial ordering between the labial feature and the tongue root feature (that is, [labial] > [ATR] instead of [ATR] > [labial])<sup>63</sup> and, more crucially, the use of [ATR] instead of [RTR]. The latter difference is related to the controversy over the "default" value of the tongue root feature in Written Manchu and requires further discussion.

X. Zhang & Drescher (2004; see also X. Zhang, 1996; Drescher & Zhang, 2005; Drescher, 2009) specifically claim that [+RTR](= [-ATR]) is the unmarked value and thus the harmony can be termed "ATR" harmony. This claim is based primarily on the following data which show that a stem with only /i/ takes an RTR suffix instead of a non-RTR suffix:

(18) /i/-only-stems taking an RTR suffix (Drescher, 2009, p. 179)

a. /a/ in suffix, not /ə/

fili	'solid'	fili-kan	'somewhat solid'
ili-	'stand'	ili-ha	'stood'

b. /ɔ/ in suffix, not /u/

sifi-	'stick in the hair'	sifi-kū	'hairpin'
-------	---------------------	---------	-----------

---

<sup>63</sup> The relative ranking between [labial] and [ATR] does not make any crucial difference under ATR analysis. If [ATR] takes scope over [labial], /ɔ/ is assigned [-ATR, +labial] and its spreading of [-ATR] and [+labial] value receives full explanations. If [labial] takes scope over [ATR] as in D&Z's analysis, /ɔ/ receives [+labial] but lacks contrastive [-ATR] specification, which may seem to be problematic. However, the fact that a non-ATR suffix is taken when labial harmony blocked can also be explained in terms of a last-resort value since [-ATR] is the unmarked value under ATR analysis. Recall that under our RTR analysis [RTR] must take scope over [labial].

cili- ‘to choke’                      cili-kū    ‘choking’

However, the above generalization that i-only-stems always takes an RTR suffix seems incorrect (J. Kim, 1993, pp. 149–152; B. Li, 1996, p. 162; Naeher, 2004, p. 130). Consider the following counterexamples:

(19) Neutral stems that take <e> in a suffix (Naeher, 2004, p. 130)

bi-	‘exist, be; stay, remain’	bi-he	‘was’
		bi-le-	‘lay eggs, give birth to pigs and dogs’
cikin	‘edge, border’	ciki-ngge (fu)	‘boundary (wall)’
cing	< Chinese?’	cing-ne	‘glue an arrowhead to the shaft’
gincihi	‘shiny through continued long use’	gincihi-ne-	‘become shiny through wear’
ilhi	‘dysentery’	ilhi-ne-	‘have dysentery’
ini	‘he, she (GEN)’	ini-ngge	‘his, her’
isi-	‘reach, arrive; approach’	isi-rei	‘imminent, approaching, impending’
ji-	‘come’	ji-he	‘came’
mini	‘I (GEN)’	mini-ngge	‘mine’
si-	‘stop, plug up, fill in’	si-he	‘stopped, plugged up, filled in’
sijin	‘line, string, fishline’	siji-le-	‘shoot an arrow with a line attached to it’
sini	‘you (GEN)’	sini-ngge	‘yours’

Thus, there is no empirical evidence in favor of [ATR] over [RTR]. Recall that I have already shown that certain neutral stems with only /i/ (and neutral /u/) take non-RTR suffixes (12)a while others take RTR suffixes (12)b. J. Kim (1993, pp. 149–152) observes the same pattern as well and takes it as evidence for two *\*i*'s, i.e., /i/ and /i/, at an earlier stage (see also Benzing, 1956, p. 21; B. Li, 1996, pp. 162–3; X. Zhang & Drescher, 2004, p. 181).

It has been observed that the African tongue root systems and the similar systems elsewhere (e.g., the Altaic systems) have reverse polarity: tongue root advancement in the former and tongue root retraction in the latter act as the dominant value (Clements & Rialland, 2008, p. 53). According to B. Li (1996, p. 318ff.), there are also notable differences in the typical vowel inventory between African and Tungusic tongue root systems. For instance, in African “ATR” languages the opposition between ATR vs. non-ATR low vowels (/ɜ/ vs. /a/) tends to disappear first creating the neutral vowel /a/, whereas in Tungusic “RTR” languages the opposition between non-RTR vs. RTR high front vowels (/i/ vs. /ɪ/) tends to disappear first, leaving /i/ as the most typical neutral vowel.<sup>64</sup> As we will see throughout this chapter, there is no known case in other Tungusic languages which requires an ATR (not RTR) analysis. Furthermore, other Altaic languages known to have tongue root harmony such as Middle Korean (Chapter 4) and many Mongolic languages (Chapter 3) have been characterized as having RTR (not ATR) harmony on the basis of markedness judgment. Thus, it is highly unlikely that Written Manchu would be the sole case that must be characterized by ATR harmony.

---

<sup>64</sup> There is no known case in other Tungusic languages which requires an ATR analysis. See B. Li (1996) and X. Zhang (1996) for further details.

Besides this typological consideration, phonological markedness also favors an RTR analysis over ATR analysis. According to one of the phonological criteria on the markedness terms by Rice (2007, p. 80), the marked is subject to neutralization, whereas the unmarked is the result of neutralization.

(20) Phonological markedness (Rice, 2007, p. 80)

Marked	Unmarked
subject to neutralization	result of neutralization
unlikely to be epenthetic	likely to be epenthetic
trigger of assimilation	target of assimilation
remains in coalescence	lost in coalescence
retained in deletion	lost in deletion

The direction of the proposed merger (/i, \*ɪ/ > /i/) in Oroch and Written Manchu and the direction of the contextual neutralization (/u, ʊ/ → [u]) in Written Manchu converge to indicate that [+RTR] is the marked value. Compare the following neutralization rules:

(21) Neutralization rule in Written Manchu

a. ATR analysis (X. Zhang, 1996, p. 83)

$$\begin{array}{c} \text{V} \\ [ \quad ] \end{array} \rightarrow [+ATR] / \begin{array}{c} \text{C} \\ -[\text{dorsal}] \end{array} \text{ ———}$$

b. RTR analysis

$$[+RTR] \begin{array}{c} \text{V} \\ \rightarrow [ \quad ] \end{array} / \begin{array}{c} \text{C} \\ -[\text{dorsal}] \end{array} \text{ ———}$$

(“-[dorsal]” indicates that the preceding segment is not a dorsal consonant.)

In the ATR analysis proposed in X. Zhang (1996), neutralization is achieved by adding a marked feature value, which is odd. By contrast, an RTR analysis would formalize the neutralization rule in a more intuitive manner.

(22) Velarization rule in Written Manchu (X. Zhang, 1996, p. 86)

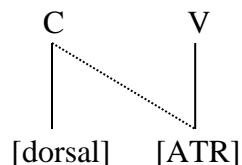

In a similar vein, the “velarization” rule in (22) proposed in X. Zhang (1996) can be reformulated as a “uvularization” rule in which the spreading feature is replaced with [RTR], considering the cross-linguistic fact that uvulars are more marked than velars (Maddieson, 1984)

It is a well known fact that uvulars are more marked than velars cross-linguistically: out of 317 languages in the UCLA Phonological Segment Inventory Database (UPSID<sup>65</sup>) investigated by Maddieson (1984, p. 32), there are 47 languages which are reported to have uvular stops whereas there are 315 languages with velar stops. It is highly likely that there would be an implicational universal as well: the presence of uvular obstruents implies the presence of velar obstruents. The result by Pericliev (2008) is suggestive in this respect, although it does not show implicational universals between all possible velar-uvular pairs.

(23) Excerpt from the implicational universals in UPSID-451 by Pericliev (2008, pp.

---

<sup>65</sup> UPSID has been extended by Maddieson & Precoda (1990) to include 451 languages (UPSID-451) and further extended by Lindblom, Krull, & Stark (1992) to include 534 languages (SUPERB UPSID).

206–213)

No.	Universal	Validity percentage	Fams/Areas	Exceptions
40	[q <sup>w</sup> ] → [k <sup>w</sup> ]	12/12 100%	4/2	
42	[q <sup>h</sup> ] → [k <sup>h</sup> ]	16/17 94%	7/2	Kwakw'ala
50	[q <sup>wʔ</sup> ] → [k <sup>wʔ</sup> ]	11/11 100%	3/2	
58	[χ <sup>w</sup> ] → [x <sup>w</sup> ]	13/14 93%	4/2	Archi

See also Donohue (2006) as well as Gamkrelidze (1978, p. 19) who notes that “there are no systems with a voiced postvelar stop /g/ and a gap in the velar group in place of the voiced /g/.”

It also has to be noted that the proposed “velarization” rule is contradictory to the proposed contrastive specifications for /i/ in (17): since /i/ lacks contrastive [+ATR], it has nothing to spread. Uvulars, the putative “default” dorsal consonants, are then expected to appear before /i/. However, contrary to this expectation, it is always velars that surface before /i/. To solve this contradiction, Zhang (1996, p. 86) claims that velars before /i/ are in fact “palatalized uvulars” which are assumed to be phonetically indistinguishable from velars. However, “palatalized uvulars” are typologically very rare, if not impossible.<sup>66</sup> Where attested, they are clearly distinguishable from velars. For example, in Bzyb (a Northwest Caucasian language), palatalized uvulars oppose with both plain velars and plain uvulars and, in Ubykh (a NW Caucasian language), palatalized uvulars do not surface as velars even though there are no plain velars (Colarusso, 1988, pp. 263–4). Note also that the proposed type of palatalization

---

<sup>66</sup> According to Hall (2000, p. 9 n.13), palatalized uvulars such as [q<sup>i</sup> ɟ<sup>i</sup> χ<sup>i</sup>] are attested only in a few Northwest Caucasian languages as reported in Colarusso (1988).



(palatalization of uvulars by /i/) is not attested in any other Tungusic languages. Rather, as is the case in Ewen (J. Kim, 2011), if there is a palatalization rule for dorsal consonants, it affects all dorsal consonants, whether velar or uvular, resulting in palatal consonants ([c] for /k/ ([k~q]) and [ɟ] for /g/ ([g~ɣ])). In fact, according to von der Gabelentz (1833, as cited in Odden 1978, p. 149, fn. 1), *k* and *g* are palatalized to “dental affricates” before /i/ in Manchu.

In contrast to the problematic “velarization” rule, the “uvularization” rule under my RTR analysis will not require any of these speculative explanations: /i/, with no [+RTR] value, does not trigger uvularization and therefore unmarked velars will surface as a default.

#### 4.2.1.2. Spoken Manchu

Spoken Manchu has the following vowel inventory:

(24) Spoken Manchu vowels

a. After the loss of /ʊ/ (Dresher, 2009, p. 181)

i   ə   u  
       a   ɔ

b. After the creation of /ɛ/ and /y/ (X. Zhang, 1996, based on Zhao 1989, Ji et al. 1989)

i   y   ə   u  
       ɛ     a   ɔ

Li (1996, pp. 174–188) proposes the same vowel inventory as (24)b for Sanjiazi Manchu, a representative of the modern Nenjiang Manchu, based on his own fieldwork. J. Kim et al. (2008), also based on their recent fieldwork for the same

Manchu variety, propose a 5-vowel system identical to (24)a, regarding /ɛ/ and /y/ in (24)b as secondary. As is clear in the above two stages, the two main developments in the Spoken Manchu vowel system are the loss of WM /ʊ/ by merger and the creation of /ɛ/ and /y/.

The completion of the merger between /u/ and /ʊ/ is exemplified in (25).

(25) The loss of /ʊ/ in Spoken Manchu (X. Zhang, 1996, p. 110)

	Written Manchu	Spoken Manchu	Gloss
a. Stem /ʊ/:	hūdun	xudun	‘quick’
	hūla-	xula-	‘read’
b. Suffix /ʊ/:	here-ku	xəri-ku	‘ladle’
	taci-kū	tatei-ku	‘school’

Distribution of /ɛ/ and /y/ in (26) shows how the two new vowels have been created.

(26) Distribution of /ɛ/ and /y/ in Spoken Manchu (X. Zhang, 1996, pp. 111–112)

	Written Manchu	Spoken Manchu	Gloss
a. /ɛ/:	ali-	ɛli-	‘bear’
	alin	ɛlin	‘mountain’
	tari-	teri-	‘cultivate’
	sain	tsɛn	‘good’
b. /y/:	tugi	tygu	‘cloud’
	tuwəri	tyli	‘winter’
	ninggun	nyŋŋun	‘six’
	ilenggu	jyruyə	‘tongue’

/ε/ and /y/ developed from a sequence of vowels: /a i/ sequence for /ε/ and /u i/ or /i u/ sequence for /y/ as illustrated in (27). Note that this shows that [coronal] is contrastive in Spoken Manchu.

(27) Creation of /ε/ and /y/ in Spoken Manchu (Dresher & Zhang, 2005, p. 63)

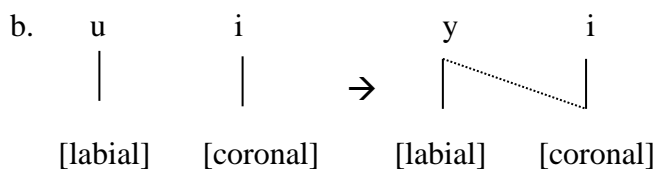
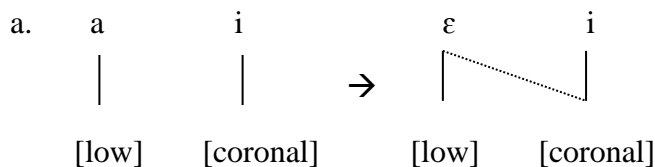

OR

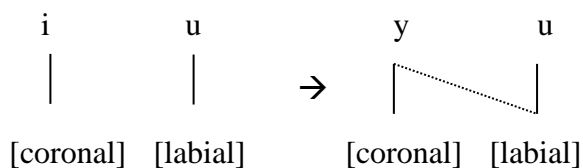

Zhang (1996) proposes the following contrastive hierarchy for Spoken Manchu:

(28) Spoken Manchu contrastive hierarchy: [low] > [coronal] > [labial]

(X. Zhang, 1996, p. 108; Dresher & Zhang, 2005, p. 66; Dresher, 2009, p. 182)

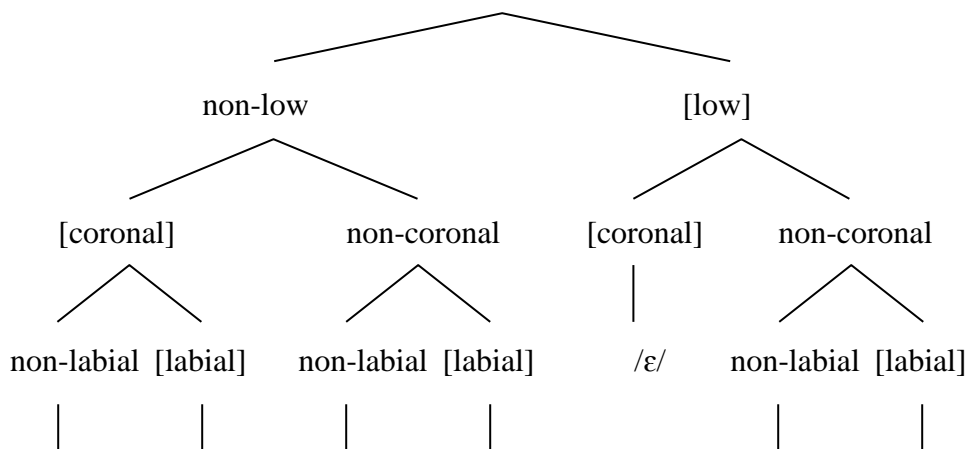

/i/            /y/            /ə/            /u/                            /a/            /ɔ/

From a contrastivist’s viewpoint, the development of Spoken Manchu vowel systems is explained with the following scenario provided by X. Zhang (1996) and Dresher & Zhang (2005). (See Dresher & Zhang 2005, p. 61ff and Dresher 2009, p. 180ff for further details. See also B. Li 1996, pp. 181-7.) The merger between the two minimally contrasting vowels /u/ and /ʊ/ in Written Manchu has completed in Spoken Manchu, resulting in the loss of /ʊ/. This leaves only one RTR harmonic pair, /ə/ and /a/. The relative height difference between these two vowels, which was a by-product of the RTR contrast and thus redundant in Written Manchu, is now reinterpreted as contrastive. Taking more advantage of the existing contrastive feature [low] (cf. Clements 2003 “feature economy”), /ə/, which was phonologically [+low] vowel with a slightly “higher” realization than /a/ in Written Manchu, is now recognized as a non-low vowel (Dresher & Zhang 2005, B. Li 1996, p. 183).<sup>67</sup> The vowel raising pattern in (29) supports this reinterpretation of /ə/ as a non-low vowel, considering the parallel raising between /a/ to /ə/ (29)a and /ɔ/ to /u/ (29)b.

(29) Vowel raising in Spoken Manchu (J. Kim, Kwon, et al., 2008, p. 17; B. Li, 1996, p. 179)

	Written Manchu		Spoken Manchu	Gloss
a. /a/ > /ə/	tasha	>	taskə	‘tiger’
	haha	>	χaxə	‘man’

<sup>67</sup> According to B. Li (1996), the actual realization of /ə/ is [i] (and he uses this symbol for the phonemic representation).

	baita	>	bəṭə	‘matter’
	nadan	>	nadən	‘seven’
b. /ɔ/ > /u/	korso-	>	qɔlsu-	‘to regret’
	onggo-	>	ɔŋŋu-	‘to forget’
	olho-	>	ɔlχu-	‘to be dry’
	songgombi	>	suŋŋum	‘to weep’

Now Spoken Manchu has two non-coronal non-low vowels, namely /ə/ and /u/, which need to be distinguished. Again, an existing feature [labial] is exploited: the “phonetic” roundedness of /u/ is now interpreted as phonological. The emergence of a new labial contrast between /ə/ and /u/ in addition to the original one between /a/ and /ɔ/ is evidenced by the following examples.

- (30) Delabialization (/u/ > /ə/) in Spoken Manchu (J. Kim, Kwon, et al., 2008, p. 17; B. Li, 1996, p. 180)

	Written Manchu		Spoken Manchu	Gloss
a. Unrounding (/u/ > /ə/)	puta	>	bəda	‘meal’
	mursa	>	mərsa	‘radish’
	futa	>	fəta	‘rope’
	mudan	>	mədan	‘turn’
b. cf. Rounding (/a/ > /o/)	basumbi	>	bosum	‘satire’

The contrastive roundedness of /u/ in Spoken Manchu is also evidenced by the creation of /y/ from /u i/ or /i u/ sequence as we have seen above: /y/ contrasts with /i/ in terms of the feature [labial], which must be contributed by /u/ (Dresher 2009, p. 181).

/u/ and /y/, in addition to the original trigger vowel /o/, trigger labial harmony.

This can be observed in the following data showing both height and labial harmony in Spoken Manchu, whereby the stem-final vowel determines the [ $\pm$ low] and [ $\pm$ labial] values of the suffix vowel.

(31) The past tense suffix in Spoken Manchu (Li 1996, p. 182)

a. If the stem-final V is [-low, -labial], then the suffix V is also [-low, -labial].

arə-xə	‘to write’	saχdə-xə	‘to become’
dazi-xə	‘to repair’	bi-xə	‘to stay’

b. If the stem-final V is [+low, -labial], then the suffix V is also [+low, -labial].

qa-χa	‘to obstruct’	sa-χa	‘to know’
ge-χa	‘to obtain’	se-χa	‘to bite’

c. If the stem-final V is [-low, +labial], then the suffix V is also [-low, +labial].

bu-xu	‘to give’	maŋu-xu	‘to grow thinner’
sy-xu	‘to mix (dough)’	nixny-xu	‘to chew’

d. If the stem-final V is [+low, +labial], then the suffix V is also [+low, +labial].

tɔ-χɔ	‘to scold’	jɔ-χɔ	‘to go’
-------	------------	-------	---------

The proposed contrastive hierarchy ensures that high rounded vowels /u/ and /y/ are assigned the contrastive [+labial] specification and explains the pattern given in (31)c. /u/ in a non-alternating suffix such as the causative voice *-bu* also “may create a new span of harmony” and spread its [+labial] to the subsequent alternating suffix (Li 1996, p. 185).

(32) Suffix of causative voice *-bu* followed by the alternating past tense suffix (Li 1996, p. 185)

va-bu-xu	‘to kill’	χɔlga-bu-xu	‘to steal’
gɛ-bu-xu	‘to obtain’	sɛ-bu-xu	‘to bite’
niɔ-bu-xu	‘to pick with a knife’	dɔ-bu-xu	‘to alight’

#### 4.2.1.3. Sibe

Sibe shows a further development of a new vowel /œ/, which results in the following eight-vowel system:

(33) Sibe (X. Zhang, 1996; Drescher & Zhang, 2005; B. Li, 1996, pp. 188–205)

i	y	ə	u
ɛ	œ	a	ɔ

The vowel /œ/ originates from /ɔ/ in an initial syllable followed by /i/ in the following syllable.

(34) The development of /œ/ in Sibe

WM (Norman, 1978)	Sibe (B. Li, 1996, p. 191)	Gloss
goi-	gœ-	‘to hit (the target)’
omi-	œmi-	‘to drink’

All rounded vowels /y, u, œ, ɔ/ should bear a contrastive [+labial] specification since they trigger labial harmony in suffixes when they appear in a stem-final position (B. Li, 1996, p. 202, (31)).

(35) Labial harmony in Sibe: suffix of non-self-perceived immediate past tense -  
*xə/-xu/-χə/-χu*<sup>68</sup> (B. Li, 1996, p. 202)

a.	<i>dʒi-xə</i>	‘to come’	<i>ici-xə</i>	‘to be enough’
	<i>tə-xə</i>	‘to sit’	<i>gənə-xə</i>	‘to go’
b.	<i>sav-χə</i>	‘to see’	<i>tykε-χə</i>	‘to watch’
	<i>fɔndʒi-χə</i>	‘to ask’	<i>æmi-χə</i>	‘to drink’
c.	<i>utu-xu</i>	‘to dress’	<i>təsu-xu</i>	‘to satisfy’
	<i>xinu-xu</i>	‘to hate’	<i>tyry-xu</i>	‘to rent’
d.	<i>lavdu-χu</i>	‘to become more’	<i>bədu-χu</i>	‘to consider’
	<i>tɔ-χu</i>	‘to curse’	<i>gœ-χu</i>	‘to hit (the target)’

The contrastive hierarchy for Sibe is given below:

(36) Sibe contrastive hierarchy: [low] > [coronal] > [labial] (Dresher & Zhang, 2005, p. 66)

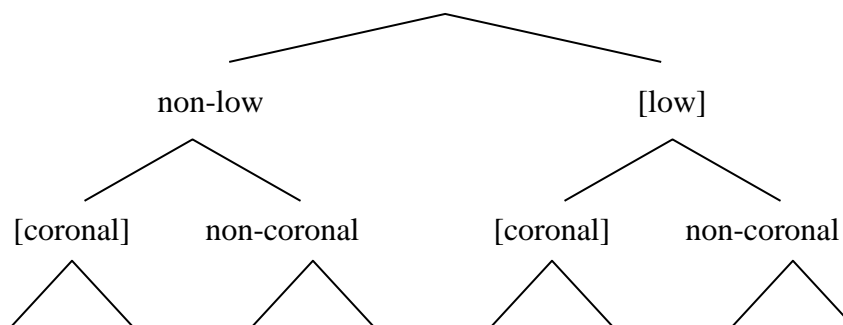

<sup>68</sup> The velar-uvular alternation in Sibe evident in this suffix alternation is analyzed as [+low] harmony in Nevins (2010, pp. 92–7): if a stem has [+low] vowel anywhere in the word, it takes a uvular (assumed to be [+low]) suffix; otherwise, it takes a velar ([-low]) suffix. In Nevins analysis, the search is relativized to marked value, i.e., [+low], and thus the unmarked vowels (with the [-low] specification) are skippable and do not block the search process. This allows a “long-distance copying of [+low] across an intervening [-low] segment” as in *fɔndʒi-χə* ‘to ask,’ *lavdu-χu* ‘to become more.’ In contrast, Spoken Manchu shows a slightly different pattern of vowel-consonant harmony: the search is relativized to contrastive value and thus the dorsal consonant of the suffix copies the nearest [±low] value, disallowing a long-distance copying.



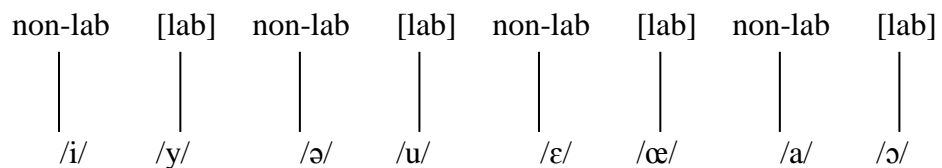

The above Sibe hierarchy is the same as that of Spoken Manchu which retained the original Written Manchu hierarchy except for the loss of [RTR]. This hierarchy is supported by the vocalic epenthesis in Sibe described by Li (1996, p. 205): /ə/ or /u/, depending on the roundedness of the preceding vowel, is inserted between a stem-final consonant and a consonantal suffix. The least marked status of these epenthetic, high back vowels /ə, u/ are captured by the feature ranking [low] > [coronal] > [labial].

## 4.2.2. Southeast Tungusic languages (*Udihe, Oroch, Ulchi, Orok, Nanai*)

### 4.2.2.1. Oroch

Oroch (or Orochi) is a Southeast Tungusic spoken in the Khabarovsk Krai, Russia, by about 250 speakers (Russian Census, 2002). Recently, Oroch vowel harmony has drawn attention of some theoretical phonologists (Kaun, 1995; Nevins, 2010; Tolskaya, 2008). Here I will provide a contrastive hierarchy analysis and compare it with the recent theoretical approaches to Oroch vowel harmony.

#### 4.2.2.1.1. *Vowel patterns in Oroch*<sup>69</sup>

Oroch has the following vowel inventory:

(37) Oroch vowels (Avrorin & Boldyrev, 2001; Avrorin & Lebedeva, 1978)<sup>70</sup>

i	i:	u	u:	
		ʊ	ʊ:	
	ə	ə:		
æ:	a	a:	ɔ	ɔ:

The above inventory seems fairly uncontroversial except the front vowel /æ/ whose status as a distinct phoneme is doubtful. This issue will be discussed in detail later.

---

<sup>69</sup> The data presented here come from Avrorin & Boldyrev (2001) and Avrorin & Lebedeva (1978), as cited in Tolskaya (2008) and Kaun (1995, pp. 68–73), respectively.

<sup>70</sup> Kazama (2003, p. 14) presents a slightly different vowel system with no distinction between /u/ vs. /ʊ/:

i	u	‘neutral’
ə		‘soft’
a	ɔ	‘hard’

Oroch displays RTR harmony whereby all vowels in a word agree in terms of the feature [RTR]. The following examples show three different suffixes, accusative suffix *-və/va-*, dative suffix *-du/dʊ-*, and focus suffix *-də/da-*, all of which alternate depending on the [ $\pm$ RTR] value of the stem.

- (38) RTR harmony:  $\boxed{-və/va/}$  $\boxed{və}$ -,  $\boxed{-du/dʊ}$ -,  $\boxed{-də/da/}$  $\boxed{də}$  (Tolskaya, 2008, p. 5)
- | Non-RTR stem |                 | RTR stem   |                |
|--------------|-----------------|------------|----------------|
| xuŋkə-və-də  | ‘canoe-ACC-FOC’ | ʊgda-va-da | ‘boat-ACC-FOC’ |
| xuŋkə-du-də  | ‘canoe-DAT-FOC’ | ʊgda-dʊ-da | ‘boat-DAT-FOC’ |

In addition to RTR harmony, Oroch exhibits another type of vowel harmony, i.e., labial harmony, whereby the low rounded vowel /ɔ/ propagates its roundness onto the suffix vowel.

- (39) Labial harmony:  $-və/va/$  $\boxed{vɔ}$ -,  $-də/da/$  $\boxed{dɔ}$  (Tolskaya, 2008, p. 5)
- ɔmɔɔ-vɔ-dɔ ‘lake-ACC-FOC’

The neutral vowel /i/ can co-occur with either non-RTR or RTR vowels in a stem as in (40) and behaves as a transparent vowel with respect to RTR harmony, as in (41).

- (40) Neutral vowel /i/ (data from Kaun, 1995, p. 73; Tolskaya, 2008, p. 8)
- | Non-RTR stem |                            | RTR stem |                        |
|--------------|----------------------------|----------|------------------------|
| idu          | ‘to roll thread into clew’ | idʊ      | ‘where?’               |
| ɪnəktə-      | ‘to laugh’                 | inda     | ‘dog’                  |
| ikə          | ‘to sing’                  | ikɔ      | ‘pot’                  |
| siiksə       | ‘evening’                  | dʒima    | ‘to stay with someone’ |

xidus	‘quickly’	dikto	‘thick’
niiŋku	‘quite small’	sijɲɔ	‘to knock out’

(41) /i/ is transparent to RTR harmony (Tolskaya, 2008, p. 5)

Non-RTR stem		RTR stem	
xuŋkə-ŋi-də	‘canoe-3SG-FOC’	uɔda-ŋi-da	‘boat-3SG-FOC’

However, /i/-only-stems display idiosyncrasy when selecting a suffixal variant: some behave as if they were non-RTR stems, whereas others behave as if they were RTR stems.

(42) Idiosyncrasy of /i/ (Tolskaya, 2008, pp. 6–7)

Non-RTR stem		RTR stem	
ippi-də (< PT *uppi)	‘to sew-FOC’	sikki-da (< PT *silku)	‘wash-FOC’
[PT = Proto-Tungusic (Starostin, Dybo, & Mudrak, 2003)]			

The vowel /æ/ shows remarkable similarities to the neutral, but sometimes idiosyncratic, vowel /i/. First, /æ/ is neutral, as in (43)a, and transparent to RTR harmony, as in (43)b.<sup>71</sup>

(43) Phonological behavior of /æ/ (Tolskaya, 2008, p. 7)

a. Neutral vowel /æ/

Non-RTR stem		RTR stem	
--------------	--	----------	--

---

<sup>71</sup> Unlike Tolskaya (2008), Kaun (1995) assumes that /æ/ belongs to the [+RTR] harmonic set based on Avrorin & Lebedeva (1978).

ŋənə-mdæ ‘walk-PART’                      ʊža-mdæ ‘follow-PART’

b. /æ/ is transparent to RTR harmony

žəŋgæ-ra ‘judge’

Second, if a stem contains only /æ/ (and another neutral vowel /i/), it can take either a non-RTR or RTR suffix:

(44) Idiosyncrasy of /æ/ (Tolskaya, 2008, pp. 6–7)

Non-RTR stem

RTR stem

isæ -məči (< PT \*is) ‘to pull-Suffix’

gæ ki-va (< PT \*giaxʊa) ‘hawk-ACC’

[PT = Proto-Tungusic (Starostin et al., 2003)]

As observed in other Tungusic languages (S. Ko, 2011a; van der Hulst & Smith, 1988), high vowels such as /i/ and /ʊ/ block labial harmony.

(45) High vowels (/i, ʊ/) are opaque to labial harmony (Tolskaya, 2008, p. 6)

ʊtəŋgʊ-ŋi-da (\*ʊtəŋgʊ-ŋi-də, \*ʊtəŋgʊ-ŋi-də) ‘kayak-3SG-FOC’

ʊtəŋgʊ-dʊ-da (\*ʊtəŋgʊ-dʊ-də, \*ʊtəŋgʊ-dʊ-də) ‘kayak-DAT-FOC’

Notice that the stem ʊtəŋgʊ ‘kayak’ takes an RTR suffix *-da* instead of *-də* after an intervening “neutral” suffix *-ŋi*. This indicates that Oroch /ɔ/ belongs to the [+RTR] harmonic set.<sup>72</sup>

<sup>72</sup> The low rounded vowel /ɔ/ shows a limited distribution (Kaun, 1995, pp. 71–72): in general, it can occur in initial syllables when a subsequent syllable contains high vowels, /i/, as in (a), or /ʊ/, as in (b), or another instance of /ɔ/, as in (c) below. Note that, unlike /ʊ/, /u/ is not allowed to follow /ɔ/. This also reveals the RTR-ness of /ɔ/.

Interestingly, /æ/ is also opaque to labial harmony.

(46) /æ/ is opaque to labial harmony (Tolskaya, 2008, p. 7)

sɔrɔdæ -da ‘greet-FOC’ (\*sɔrɔdæ -dɔ)

#### 4.2.2.1.2. Contrastive hierarchy for Oroch

The vowel patterns in Oroch and their implications for feature specifications can be summarized as follows:

(47) Summary of Oroch vowel patterns

- a. /i/ is neutral to RTR harmony and thus lacks contrastive [-RTR]. ← (40), (41)  
However, /i/-only stems act either as non-RTR stems or RTR stems. ← (42)
- b. /i/ must be specified for [coronal], considering the origin of “/æ/”<sup>73</sup>
- c. There is no evidence that /u/ and /ʊ/ bear contrastive [+labial], although they are phonetically [+labial]: they do not trigger labial harmony. ← (39)
- d. /ɔ/ triggers labial harmony, thus bears a [+labial] specification. ← (39)
- e. /ɔ/ triggers RTR harmony even when labial harmony is blocked. Thus, it must bear a [+RTR] specification. ← (45), (46)

---

The distribution of /ɔ/ in Oroch (Kaun, 1995, p. 71):

(i) dɔdip	‘to be heard’	(ii) mɔɔsʊ	‘cover, case’
dʒɔnisi	‘to yawn’	xɔɔsʊ	‘scraper’
(iii) dɔrɔ	‘law’	dɔɔɔ	‘lame’
xɔŋɔ	‘other, another’	mɔŋɔksɔ	‘larynx’
tɔŋɔŋkɔ	‘to come unscrewed’		

<sup>73</sup> There is not much discussion in the literature on the palatalizing effect of /i/ in Oroch. But, as we will see later, the existence of the putative distinct vowel “/æ/” indicates that [coronal] is contrastive for /i/ in Oroch since the vowel quality can be understood as the surface realization of the underlying /i+a/, i.e., as a result of (synchronic) vowel contraction (cf. J. Kim, 1996).

- f. A height distinction is contrastive: (i) labial harmony is confined to low vowels and (ii) all high vowels block labial harmony. ← (39), (45)

The contrastive hierarchy I propose for Oroch vowels is given in (14):

(48) Contrastive hierarchy for Oroch

- a. SDA: [low] > [coronal] > [RTR] > [labial]

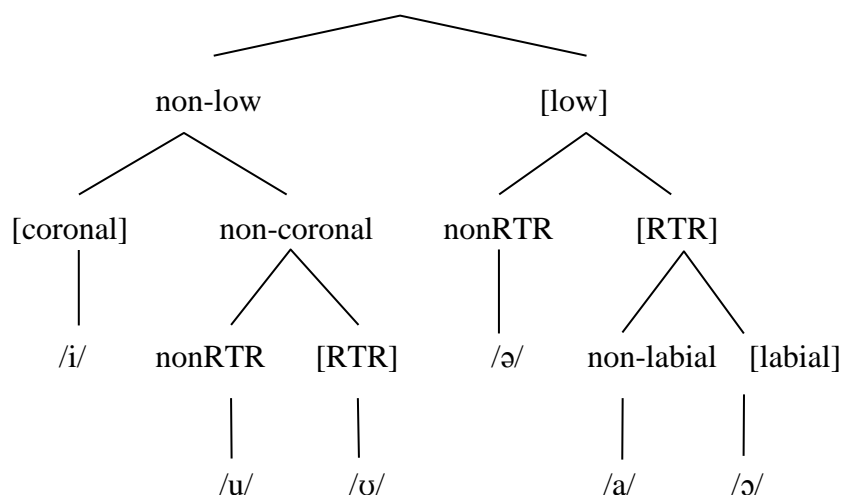

- b. Output specifications

/i/ = [-low, +cor]

/u/ = [-low, -cor, -RTR]

/ʊ/ = [-low, -cor, +RTR]

/ə/ = [+low, -RTR]

/a/ = [+low, +RTR, -lab]

/ɔ/ = [+low, +RTR, +lab]

Note that the proposed Oroch contrastive hierarchy is identical to the Written Manchu hierarchy. This is a natural consequence considering the striking similarities in the vowel inventory and the vowel-related patterns in the two languages. Therefore, I will not repeat the ranking argument here. See the analysis of Written Manchu in §4.2.1.1.3.

I deliberately excluded the vowel /æ/ from the above contrastive hierarchy for Oroch. This is because I treat it as a diphthong.<sup>74</sup> The peculiarities of “/æ/,” i.e., the transparency with respect to RTR harmony, the idiosyncrasy in selecting a suffix variant, and the opacity with respect to labial harmony, all receive plausible explanation when we postulate the underlying representation of the surface vowel [æ:] as /ia/,<sup>75</sup> or /iə/ in marginal cases. For some lexical items, “/æ/” is indeed in free variation with /ia/, /iə/, and /i/ (Tolskaya, 2008, p. 7).

(49) Free variation of /æ/ with /iə/, /ia/, and /i/ (Tolskaya, 2008, p. 7)

bæ skə	~	biəskə	‘after all’
bæ -va	~	bia-va	‘moon-ACC’
badæ	~	badi	‘more’

The underlying /ia/ this explains the idiosyncrasy of the surface vowel [æ:] in RTR harmony. The source of the “hidden” [±RTR] value is the /a/ or /ə/ portion which is obscured by the vowel contraction at the phonetic level.<sup>76</sup> The high vowel portion /i/

<sup>74</sup> Similarly, Kazama (2003, p. 14) also excludes /æ/ from the inventory of Oroch short vowels, treating it as /ia/, as in the following examples. (Note he assumes only 5 vowel phonemes, /i, ə, a, u, o/, without distinguishing /u/ and /ʊ/):

Kazama (2003)	cf. Avrorin & Boldyrev (2001, p. 19)	Gloss
/kulia/ (31), p. 34	/kʊlæ/	‘worm, insect’
/bia/ (55), p. 47	/bæ/	‘moon’
/nia/ (96), p. 66	/ɲæ/	‘person, man’
/jaanami/ (114), p. 75	/jæ mi/	‘why’

<sup>75</sup> This analysis is partly consistent with J. Kim’s (1996) observation that the long vowel  $\bar{e}$  emerges as a result of the contraction of /aj/ or /ja/ (p. 29).

<sup>76</sup> Similarly, [ee] and [εε] in Oroqen (Northern Tungusic) seem to block labial harmony, e.g.,  $\text{ɔmɔlɛɛ-sal}$  ‘grandson-PI’ (X. Zhang, 1996, p. 180), cf.  $\text{kɔrɔgɔ-sɔl}$  ‘pheasant-PI’ (X. Zhang, 1995, p. 171). This also receives a straightforward explanation when we assume /iə/ and /ia/ for the underlying representation of [ee] and [εε], respectively.



is, then, the source of other aforementioned peculiarities: transparency/opacity in RTR/labial harmony.

It should be noted that this is not an abstract analysis since there is phonetic evidence. First, the analysis is supported by the fact that “/æ/” always surfaces as a long vowel and is phonetically “slightly diphthongal, starting with an ultra-short [i]” (Tolskaya, 2008, p. 30). Figure 1 shows the spectrogram of the Oroch word /kolia/ [qʊʎja:] ‘worm’<sup>77</sup> which is transcribed as /kʊlæ/ in Avrorin and Boldyrev (2001, p. 19). Note the conspicuous “rising” (F1) and “lowering” (F2) transitions of the first two formants in the interval for [j] in the spectrogram.

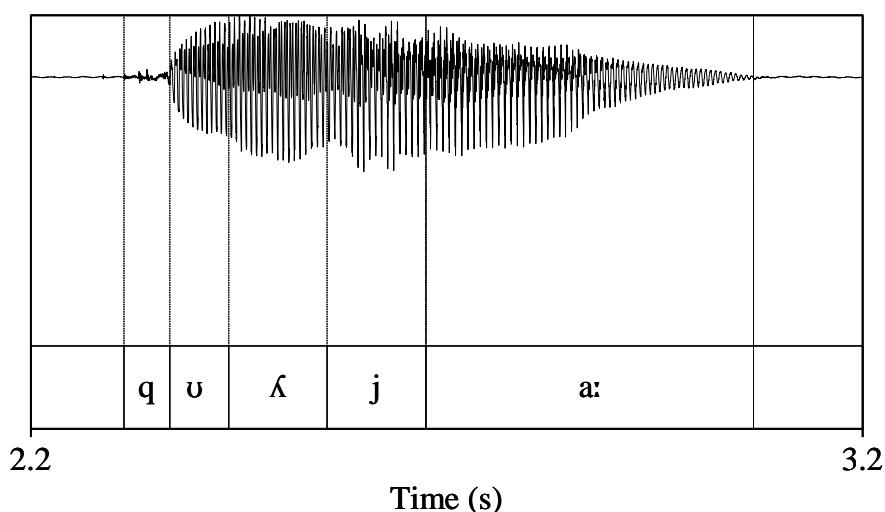

Figure 6. Spectrogram of the Oroch word /kolia/ [qʊʎja:] ‘worm.’

<sup>77</sup> It was recorded in Habarovsk, Russia, in December 2008 by the fieldworkers of the project ASK REAL (the Altaic Society of Korea, Researches on Endangered Altaic Languages). I am very grateful to the principal investigator Prof. Juwon Kim who allowed me to use the ASK REAL materials. More information on the fieldwork research can be found at the ASK REAL Digital Archives ([http://altaireal.snu.ac.kr/askreal\\_v25/](http://altaireal.snu.ac.kr/askreal_v25/)).

#### 4.2.2.1.3. *Alternative approaches to Oroch vowel harmony*

The above proposed contrastive hierarchy explains the observed Oroch vowel patterns. However, Tolskaya (2008) and Nevins (2010) argued that a contrastive hierarchy approach fails to generate the right specifications for Oroch vowels and proposed different solutions. Let's take a look at their criticisms in turn.

##### 4.2.2.1.3.1. **Tolskaya (2008)**

Tolskaya (2008, pp. 24–27) rejects any contrastive hierarchy analysis for Oroch<sup>78</sup> because she believes that the idiosyncrasy of neutral-vowel-only stems in (42) and (44) is “an unsolvable problem” within a contrastive hierarchy approach (p. 26). However, this problem is not intrinsic to the contrastive hierarchy theory. Rather, idiosyncratic stems require special treatment regardless of what kind of approach we adopt. We will shortly see Tolskaya's own approach is not free from this requirement.

Tolskaya's main concern is what she calls “neutral trigger vowels,” i.e., /i, æ/. Based on Stratal OT (Kiparsky, 2000), Tolskaya assumes /ɪ/ (the [+RTR] counterpart to /i/), /o/ (the [-RTR] counterpart to /ɔ/), and /e/ (the [-RTR] counterpart to /æ/) in the “underlying” vowel inventory, which are neutralized as [i], [ɔ], and [æ], respectively, in the “surface” inventory.

---

<sup>78</sup> The only contrastive hierarchy that Tolskaya considers consistent with phonological patterns of Oroch is [coronal] > [low] > [RTR] > [labial], denying the possibility of postulating [low] > [coronal] instead of [coronal] > [low]. (Here I replaced [dorsal] with [coronal] for consistency's sake.) Tolskaya explained that, if [low] takes scope over [coronal], /æ/ would be specified as [+low] and expected to participate in the labial contrast along with the other low vowels. However, the situation would be the same under Tolskaya's hierarchy: the first cut made by [coronal] would give /i, æ/ a specification [+coronal] and then the second cut made by [low] would distinguish the two coronal vowels by specifying [-low] to /i/ and [+low] to /æ/. Tolskaya is right in a sense: the situation cannot be saved by any contrastive hierarchy. However, we have already seen a solution to this problem: I analyzed “/æ/” as underlying /ia/ based on phonetic and phonological evidence.

(50) “Underlying” vs. “surface” vowel inventory in Oroch (Tolskaya, 2008, p. 12)

a. Underlying inventory

Non-RTR	i i:	u u:	ə ə:	o o: <sup>79</sup>	e
RTR	ɪ ɪ:	ʊ ʊ:	a a:	ɔ ɔ:	æ

b. Surface inventory

Non-RTR	i i:	u u:	ə ə:		
RTR		ʊ ʊ:	a a:	ɔ ɔ:	æ

The input of a neutral-vowel-only root at the “stem” level is assumed to be specified for [±RTR] value and thus trigger RTR harmony (p. 17). Then, at the “word” level, a neutralization process eliminates the underlying distinction between /i/ and /ɪ/, /o/ and /ɔ/, and /e/ and /æ/, leaving only [i], [ɔ], and [æ], respectively. This is illustrated in the tableaux (51) below with examples *isə -məči* ‘rope pulling game’ and *gæ ki-va* ‘hawk-ACC.’

(51) Tableaux for *isə -məči* and *gæ ki-va* (Tolskaya, 2008, p. 23)

a. /ise-mAčI/ → iseməči → [isæməči] ‘rope pulling game’

STEM LEVEL			
ise-mAčI	EXTEND RTR	IDENTRTR	*LOWFRONT[-RTR](*e)
a. → iseməči			*
b. isæməči		*!	
c. isæməči	*!		
WORD LEVEL			
iseməči	*LOWFRONT[-RTR](*e)	IDENTRTR	EXTEND RTR
a. iseməči	*!		
b. isæməči		**!	*
c. → isə məči		*	*

<sup>79</sup> These vowels /o, o:/ seem to be mistakenly omitted in Tolskaya’s underlying inventory and thus added by the author.

b. /gæ ki-vA/ → gækiʋa → [gækiʋa] ‘hawk-ACC’

STEM LEVEL			
gæ ki-vA	EXTEND RTR	IDENRTR	*HiFRONT[+RTR](*_I)
a. → gæ ki-va			*
b. geki-və		*!	
c. gæ ki-və	*!		
WORD LEVEL			
gæ kiʋa	*HiFRONT[+RTR](*_I)	IDENRTR	EXTEND RTR
a. gæ ki-va	*!		
b. gæ ki-və		**!	*
c. → gæ ki-va		*	*

The two stems in the above tableaux, *isæ* and *gæ ki*, have as their input forms /ise/ and /gæ ki/ with all the vowels bearing a [±RTR] value. At the stem level, those candidates satisfying both a harmonizing constraint (EXTENDRTR) and a faithfulness constraint (IDENRTR) are selected as optimal output. Then, at the word level, the RTR contrast between /i/ vs. \*/i/ and \*/e/ vs. /æ/ is neutralized due to higher-ranked markedness constraints such as \*LOWFRONT[-RTR] (= “\*e”) and \*HiFRONT[-RTR] (= “\*i”).

However, this approach to Oroch RTR harmony faces both theoretical and empirical problems. First, as the above summary makes clear, Tolskaya’s analysis exploits abstract underlying representations and rules of absolute neutralization<sup>80</sup> which are “typically not postulated unless a good deal of language-internal motivation can be mustered” (Kenstowicz, 1994, p. 112). In a similar vein, it is undesirable to employ extra machinery such as the distinction between stem vs. word level to deal only with the exceptional behavior of /i, æ/. It should also be noted that an abstract analysis raises a question about the learnability of abstract phonemes. See Cole &

<sup>80</sup> This approach constitutes a violation of the well known Alternation Condition (Kiparsky, 1968). I will not dwell on the controversy over abstractness in phonology in 1970s (Hyman, 1970; Kenstowicz & Kisseberth, 1979; Kiparsky, 1968), which still remains unresolved.

Hualde (2010) for a general overview on the issue of abstractness in underlying representations.

Second, since the surface [ɔ] has two underlying sources, namely /o/ and /ɔ/, it is expected that the surface [ɔ] patterns together with the surface [i] and [æ] with respect to RTR harmony, taking both RTR and non-RTR suffixes depending on the lexical item when it is the only stem vowel. However, as revealed in cases in (45) and (46) where labial harmony is blocked, [ɔ] invariantly takes an RTR suffix.

Alternatively, in favor of surface-true representations, the basic intuition that the neutral-vowel-only roots should be marked underlyingly for their [±RTR] value can be achieved by treating them as true exceptions. This means that lexical items such as *isæ* and *gæki* should bear information on their behavior with regard to vowel harmony. Note that such an approach would cost no more: in Tolskaya's approach we need the same information to correctly postulate \*/i/ or \*/ɪ/ in the underlying representations.

Next, to explain the opacity of certain vowels in labial harmony, Tolskaya adopts Kaun's (1995) constraint-based approach which exploits the following constraints and their ranking.

(52) Constraints (Kaun, 1995)

a.  $\text{EXTEND}^{\text{R};\text{-HI}}$

The autosegment [+round] must be associated to all available vocalic positions within a word when simultaneously associated with [-high]

b.  $\text{Uniform}^{\text{R}}$

The autosegment [+round] may not be multiply linked to slots bearing distinct feature specifications (for height).

Not listed in (52) is a faithfulness constraint IDENT[HI] which requires a faithful mapping between the input and the output.

The following tableau illustrates how labial harmony is blocked by the high rounded vowel /ʊ/ in Oroch. The constraint ranking, IDENT[HI], EXTEND<sup>R</sup><sub>IF<sup>-HI</sup></sub> >> UNIFORM<sup>R</sup> selects the non-harmonized, first candidate as an optimal output. The other two harmonized candidates are suboptimal. The second candidate violates the UNIFORM constraint because the [+round] feature is multiply linked to the [+high] rounded vowel [ʊ] and the [-high] rounded vowel [ɔ]. The third candidate violates the IDENT[HI] constraint because the [+high] vowel [ʊ] in the input has changed into the [-high] vowel [ɔ] in the output.

(53) Blocking of labial harmony by a high rounded vowel (Tolskaya, 2008, p. 20)

/ikɔ-dʊ-dɑ/	IDENT[HIGH]	UNIFORM	EXTEND[RD]IF[LOW]
a. → ikɔ-dʊ-dɑ     RD RD			*
b. ikɔ-dʊ-dɔ ↙ ↘ RD		*!	
c. ikɔ-dɔ-dɔ ↙ ↘ RD	*!		

However, Tolskaya (2008) does not provide any account for the opacity of /i, æ/ to labial harmony, which makes it difficult to evaluate the overall adequacy of her analysis.<sup>81</sup>

<sup>81</sup> Kaun (1995) provides a solution to the opacity of /i/ in Tungusic in general based on ad hoc *transparency continuum* (p. 214). This alternative approach will be dealt with in 4.2.3.5 in great detail. At this point, I would like to point out that Kaun (and Nevins as well, as will be introduced shortly) treats the opacity of high “rounded” vowels such as /u/ and /ʊ/ and the opacity of other vowels such as /i/ and /æ/ separately. This constitutes a contrast to my unified analysis.

#### 4.2.2.1.3.2. Nevins (2010)

Nevins (2010) claims that any possible ordering of the four features [ $\pm$ high,  $\pm$ back,  $\pm$ round,  $\pm$ ATR] (which correspond to [ $\pm$ low,  $\pm$ coronal,  $\pm$ labial,  $\pm$ RTR] in my analysis) would fail to generate the right specifications for Oroch vowels (p. 114-5).

Specifically, he argues that Oroch /i, æ/ are invisible to RTR harmony and therefore must lack [RTR] specification, while they are visible to labial harmony and therefore must bear [labial] specification (p. 114).

(54) [Allegedly] desired outcomes of underspecification in Oroch, given an underspecification approach to harmonic participation (Nevins, 2010, p. 114, with features modified accordingly)

- a. Desideratum 1 (D1): /i, æ/ must lack specification for [ $\pm$ RTR], all other vowels must have it.
- b. Desideratum 2 (D2): /i, æ/ must bear specifications for [ $\pm$ labial].

The contrastive hierarchy in (14) (cf. (55)c.iii above) satisfies the first condition (/i, æ/ lacking a [ $\pm$ RTR] value) by giving /i, æ/ only the specifications for [low] and [coronal]. However, the second condition (/i, æ/ bearing a [-labial] specification) cannot be satisfied by any of the possible orderings. This is inevitable: since there is no [+labial] counterpart to /i, æ/, there is no way to assign [-labial] value to them. This is shown in (55) where all the logically-possible feature orderings fail to satisfy both desiderata.

(55) Possible outcomes of the Successive Division Algorithm for Oroch given [ $\pm$ low,  $\pm$ coronal,  $\pm$ labial,  $\pm$ RTR] (Nevins, 2010, pp. 114–115, with features modified accordingly)

- a. Choose [ $\pm$ RTR] first: FAILS, since it will assign [ $\pm$ RTR] to /i, æ/, contra D1
- b. Choose [ $\pm$ coronal] first: FAILS, since /i/ will not be later assigned [-labial], contra D2
- c. Choose [ $\pm$ low] first: assigns [-low] to /i, u, ʊ/, [+low] to /æ, ə, a, ɔ/
  - i. If [ $\pm$ RTR] chosen next: FAILS, since it will assign [ $\pm$ RTR] to /i, æ/, contra D1
  - ii. If [ $\pm$ coronal] chosen next: FAILS, since /i/ will not be later assigned [-labial], contra D2
  - iii. If [ $\pm$ labial] chosen next: only /ɔ/ will have [+low, +labial], and as /ɔ/ will not be later assigned [ $\pm$ RTR], contra D1, FAILS
- d. Choose [ $\pm$ labial] first: assigns [+labial] to /u, ʊ, ɔ/ and [-labial] to /i, æ, ə, a/
  - i. If [ $\pm$ RTR] chosen next: FAILS, since it will assign [ $\pm$ RTR] to /i, æ/, contra D1
  - ii. If [ $\pm$ low] chosen next: only /ɔ/ will have [+low, +labial], and as /ɔ/ will not be later assigned [ $\pm$ RTR], contra D1, FAILS
  - iii. If [ $\pm$ coronal] chosen next: assigns [-coronal] to /u, ʊ, ɔ, ə, a/ and [+coronal] to /i, æ/
 

If [ $\pm$ low] chosen next: only /ɔ/ will have [+low, -coronal,+labial], and as /ɔ/ will not be later assigned [ $\pm$ RTR], contra D1, FAILS
  - iv. If [ $\pm$ RTR] chosen next: FAILS, since it will assign [ $\pm$ RTR] to /i, æ/, contra D1

Nevins's approach to Oroch vowel harmony will be revisited in detail later in §5.5.2. Here it would suffice to point out that a contrastive hierarchy analysis is not impossible, as I have already shown, and that the alleged problem of not assigning [-labial] to /i, æ/ is not really a problem but rather should be viewed as a virtue in our



contrastive hierarchy analysis: The [±labial] specification for the intervening vowels is not contrastive, and thus irrelevant to the phonological computation. Recall that the blocking effect is explained solely by contrastive “height” difference between the low trigger/target vowels and the high intervening (and thus blocking) vowels.

On the contrary, the [±labial] specification for the intervening vowels is crucial in Nevins’s approach. He views the blocking of labial harmony as what he calls *defective intervention* effects. Here is Nevins’s scenario: /i, u, ʊ/ in Oroch are visible in labial harmony due to the all-[±round]-value relativization of labial harmony. However, they are only “defectively” so because they do not satisfy an additional restriction on the same height specification between the value seeker and the value giver. It is this defectiveness that halts the search process and hence makes the high vowels block labial harmony.<sup>82</sup> However, once we discard the validity of Desideratum 2, we can safely dismiss Nevins’s objection to the contrastive hierarchy approach not assigning [±labial] value to the blocking vowels.

In Chapter 5, I will provide more detailed comparison between my contrastive hierarchy-based approach and other alternatives (including Nevins’s) to the well-known contrast between Tungusic and Mongolic with respect to the transparency and opacity in vowel harmony. We will see there that Nevins’s approaches provide quite different solutions to the Written Manchu and the Oroch vowel harmony patterns despite the striking similarities between the two languages.

#### **4.2.2.2. Udihe**

Udihe (Udehe, Udeghe) has been described to have the following vowel systems:

---

<sup>82</sup> Notice that this does not explain the blocking effect of /æ/ since it is a low vowel.

(56) Udihe vowels

a. Girfanova (2002)

front		central	back	
unround	round	unround	round	
i			u	high
e	ø <sup>83</sup>	ə	o	mid
æ		a		low

b. Nikolaeva & Tolskaya (2001, pp. 35–37): Bikin-Iman dialect

front		central	back	
unround	round	unround	round	
i	i:	y	y:	u u: high
	ie	ø	ø:	ə ə: o o: mid
æ	æ:	a	a:	low

c. Kazama (2003, p. 13)

i	u	‘neutral’
ə		‘soft’
a	ɔ	‘hard’

d. Tsumagari (2010, 2011): Bikin dialect

i, e [ə], a, o, u

Note that Kazama and Tsumagari all agree that Udihe has only 5 vowel phonemes /i, u, ə, o, a/, viewing “palatalized vowels” such as /y, ø, æ/ as diphthongs. Girfanova (2002) and Nikolaeva & Tolskaya (2001) themselves also recognize that these vowels are of secondary origin, “usually developed as a result of Umlaut-like changes in the quality

---

<sup>83</sup> I replaced Girfanova’s symbol “ø” with “ø.”

of the primary vowel under the influence of the vowels in the following syllable” (2001, p. 43). Also, according to Nikolaeva & Tolskaya (pp. 36-7), there is no evidence for the short /e/ (which is present in Girfanova’s system) at least in the Bikin dialect. Hence, I will assume the following 5 vowel phonemes for Udihe:

(57) Udihe vowels

i      u  
       ə    o  
       a

Here I use /o/ instead of Kazama’s (2003) /ɔ/. Kazama classifies the open rounded vowel /ɔ/ as a “hard” vowel. However, the alternations between /ə/ and /o/ described in Nikolaeva & Tolskaya (2001) suggest that /o/ is not a “hard” but a “soft” vowel, although this decision is only provisional.

The contrastive hierarchy I propose for Udihe is as follows:

(58) Udihe contrastive hierarchy

a. SDA: [low] > [coronal] > [RTR] > [labial]

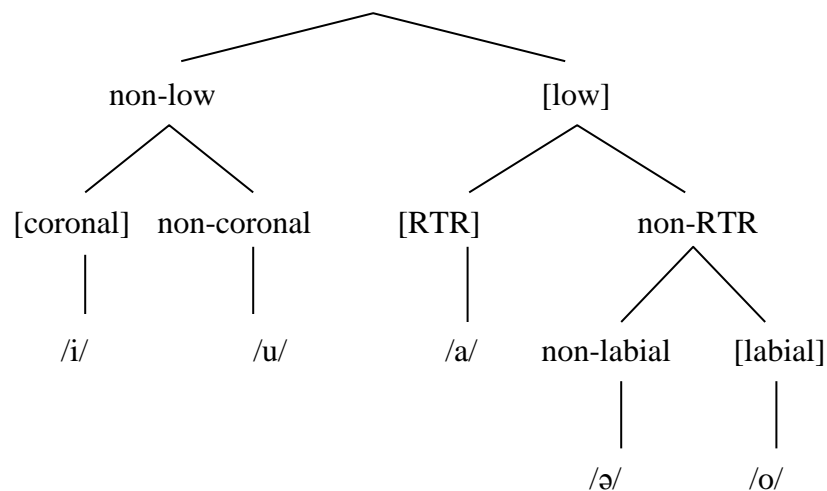

b. Output specification:

/i/ = [-low, +cor]

/u/ = [-low, -cor]

/ə/ = [+low, -RTR, -lab]

/o/ = [+low, -RTR, +lab]

/a/ = [+low, +RTR]

The above contrastive hierarchy is supported by the identified phonological patterns in Bikin dialect described in Nikolaeva & Tolskaya (2001).

There are several pieces of evidence that [coronal] is contrastive in Udihe. First of all, the two distinct phonemes /n/ and /ɲ/ (cf. *nəŋu* ‘younger sibling’ vs. *ɲəŋu* ‘wolf’) do not contrast before /i/ and palatalized vowels such as /ie, ø, æ/: only a palatal /ɲ/ can occur in this context (Nikolaeva & Tolskaya, 2001, pp. 54–55). Another manifestation is the “alternation” of the alveolar affricate /ts/ with the palato-alveolar affricate /č/ before the front vowels /i/, /i:/, /ie/, /ø/, /ø:/, /æ/, /æ:/: e.g., *čöŋki* ‘juice of the tree,’ *čika-* ‘gnaw,’ *anči* ‘no,’ *činda* ‘little bird,’ *čä* ‘burbot fish’ (p. 55). Labials /b, p/, dentals /s, l/, and velars /k, x, ɣ/ are also allophonically palatalized before front vowels: e.g., *bæ* [bʲæ:] ‘month,’ *gida* [gʲida] ‘spear,’ *aisi* [aisʲi] ‘gold,’ *tokö* [tokʲö] ‘cloud’ (p. 55). Reduction of the word-final /i/ in rapid speech may leave a palatalized final consonant as well: e.g., *ŋənə-zə-fi* → *ŋənə-zə-fʲ* ‘go-subj-1pl.in,’ *gagda-ni* → *gagda-nʲ* ‘another-3sg,’ *læ si* → *læ sʲ* ‘very, a lot’ (p. 49).

Other contrastive features are evidenced by the vowel harmony pattern. Udihe has both RTR and labial harmony,<sup>84</sup> whereby the quality of suffix vowel is determined by the root-final vowel:

(59) Root-final      Suffix      (Nikolaeva & Tolskaya, 2001, p. 74)

<sup>84</sup> According to Nikolaeva & Tolskaya (p. 72), Udihe has a “height” and “rounding” harmony.

- a. /a/                    /a/
- b. /ə/ /i/ /u/        /ə/
- c. /o/                    /o/

The harmony pattern is illustrated by the following examples:

(60) Vowel harmony (Nikolaeva & Tolskaya, 2001, p. 75)

		ACC	LOC
a.	'ana        'boat'	'ana-wa	'ana-la
	kuliga     'snake'	kuliga-wa	kuliga-la
	abuga     'father'	abuga-wa	abuga-la
b.	nəki       'spring'	nəki-wə	nəki-lə
	kusigə    'knife'	kusigə-wə	kusigə-lə
	adili      'net'	adili-wə	adili-lə
c.	zolo       'stone'	zolo-wo	zolo-lo
	ifokto    'bird cherry'	ifokto-wo	ifokto-lo
	miondo   'gun'	miondo-wo	miondo-lo

From the above examples, we notice that only low vowels /a, ə, o/ appear in harmonizing suffixes. This grouping of vowels into /a, ə, o/ and /i, u/ suggests that a height feature, say, [low] is contrastive. Both Nikolaeva & Tolskaya (2001, p. 44) and Tsumagari (2010, p. 107) illustrate another piece of evidence that /i, u/ are grouped together.

(61) /i/ ~ /u/ alternation in Udihe

- a. Locative suffix + 3SG (Tsumagari, 2010, p. 107)

-di-ni (< -du-ni)

-dila-ni (< -dula-ni)

b. kuandugu ~ kuandigu ‘ankle-bone’ (Nikolaeva & Tolskaya, 2001, p. 44)

mun-tugi (< mun-tigi) ‘we-LAT’

The above alternation, no matter what its nature is, can be better explained under the relative hierarchy [low] > [coronal], whereby /i/ and /u/ form a minimal contrast: /i/ = [-low, +coronal] vs. /u/ = [-low, -coronal]. If [coronal] comes first, on the contrary, it will first distinguish /i/ from all other vowels (non-coronal vowels). Next, the second feature [low] applies to separate /u/ from all other vowels (low vowels). The result is that /i/ receives [+coronal] whereas /u/ receives [-coronal, -low].

Non-low vowels /i, u/ can co-occur with any of /a, ə, o/ root-internally (p. 73) and transparent to harmony, e.g., *aziga-wa* ‘girl-acc,’ *abuga-wa* ‘father-acc’ (p. 76). This shows that /i, u/ lack the contrastive specifications for the harmonic features. On the contrary, however, root-final and suffixal /i, u/ are opaque and block both type of harmony (p. 75):

(62) Root-final and suffixal high vowels block harmony (Nikolaeva & Tolskaya, 2001, p. 75)

a. Root-final opaque /i, u/

ataxi-wə ‘spider-ACC’

tal-u-wə ‘birch tree-ACC’

b. Suffixal opaque /i, u/

’ana-ŋi-wə-ni ‘his boat’ (boat-AL-ACC-3SG)

zolo-ŋi-wə-ni ‘his stone’ (stone-AL-ACC-3SG)

nodo-u-zəŋə ‘to lose-2PL-FUT’ cf. nodo-zoŋo ‘to lose-FUT’ (p. 227)

I assume that, in Udihe, RTR harmony as well as labial harmony is height-stratified, considering that both [RTR] and [labial] features are only contrastive among low vowels. See Chapter 5 for a formal analysis of the height-stratified harmony.

Unlike the low rounded vowel /o/, /u/ does not trigger labial harmony. This supports our analysis that /i, u/ are distinguished by [coronal], not by [labial], and no further feature specification including [labial] is required for /u/.

The relative hierarchy between [RTR] and [labial] is not so crucial and may be reversed.

The Udihe harmony pattern may be equally well explained under an alternative contrastive hierarchy [high] > [coronal] > [low] > [labial] which uses [high] instead of [low] to distinguish /i, u/ from /ə, a, o/ and [low] instead of [RTR] to distinguish /ə/ from /a/. However, it has no advantage except that it employs more widely used features. Rather, it is less desirable considering other Tungusic languages for which I have established similar RTR-based hierarchies.

#### 4.2.2.3. Ulchi

Ulchi (Ulch, Ulcha, Ulych, Olch, Olcha), spoken in Ulchskij District of Khabarovsk Krai, Russia, by only about 700 speakers (Russian Census, 2002), has been reported to have the following vowel system:

(63) Ulchi vowels (Kaun, 1995, p. 74; Sunik, 1985; Walker, 2001)

	Front	Central	Back	
High	i i:		u u:	non-RTR
	ɪ ɪ:		ʊ ʊ:	RTR
Nonhigh		ə ə:		non-RTR

ε ε:    a a:    ɔ ɔ:    RTR

Kazama (2003, p. 14) includes /o/ (/ə/ in his system) but excludes /ε/ from his Ulchi vowel inventory. Kazama's treatment of [ε] seems right: it appears only in initial syllables (Walker 2001) and, as in other Tungusic languages, is likely to be of a secondary origin.

(64) [+RTR] vowel words (first syllable contains [ε]) (Kaun, 1995, p. 76)

mɛvtɪ	‘gun’	ɲɛ:lɪ	‘unconscious’
bɛ:lɪbɔɔ	‘to deny a request’	ɛrkɔvɔ	‘to insult’
bɛlta	‘moonlight’	gɛva	‘dawn, daybreak’
		(gɛva - typo?)	

The above examples show that [ε] is restricted only to initial syllables and may be followed by any of the vowels /ɪ/, /ʊ/, or /a/: this positional and co-occurrence restriction can be easily understood if we assume that [ε] originates from /ɪ+a/. For example, *gɛva* ‘dawn’ corresponds to *gɪwana* in Najkxin Nanai. Thus, I exclude /ε/ from the contrastive hierarchy below:

(65) Ulchi contrastive hierarchy

a. SDA: [low] > [coronal] > [RTR] > [labial]

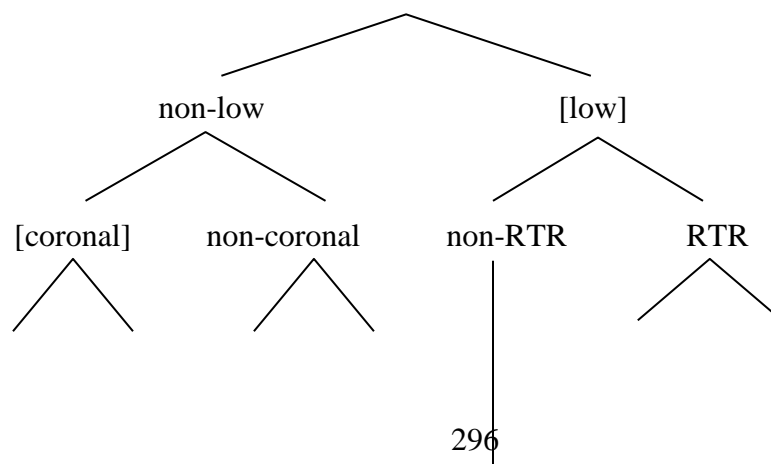



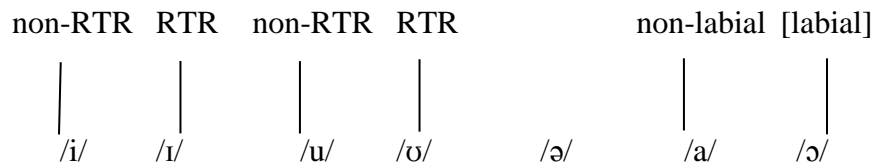

b. Output specification

- |  |                          |
|--|--------------------------|
| /i/ = [-low, +cor, -RTR]                             | /u/ = [-low, -cor, -RTR] |
| /ɪ/ = [-low, +cor, +RTR]                             | /ʊ/ = [-low, -cor, +RTR] |
| /ə/ = [+low, -RTR]                                   |                          |
| /a/ = [+low, +RTR, -lab]    /ɔ/ = [+low, +RTR, +lab] |                          |

The RTR harmony pattern is illustrated below:

(66) RTR harmony (Kaun, 1995, pp. 75–76)

Non-RTR words	RTR words
a. /i/ vs. /ɪ/ in initial syllables	
bi:si      ‘to not exist’	gɪɾɪ      ‘river bed’
miŋgi      ‘my’	kɪɾɪ      ‘seagull’
bibu      ‘to live’	pɪpʊ      ‘reed fife’
gi:luqtu    ‘fly (insect)’	sɪlčʊ      ‘sack for tinder’
bilə      ‘probably’	bɪldʒa      ‘throat’
di:rə      ‘small shovel’	sɪ:ŋna      ‘gift, present’
b. /u/ vs. /ʊ/ in initial syllables	
bu:li      ‘lamp wick’	gʊɾɪ      ‘thirty’
muŋti      ‘cooly’	mʊɾɪ      ‘horse’
bu:bu      ‘to gie’	lʊmbʊm    ‘file, row’
kuŋdu      ‘sturgeon’	gʊ:vʊ      ‘find one’s way’
buksə      ‘cartilage’	pʊtsta      ‘dust’

pu:msə	‘filings’	buqta	‘fragment’
c. /ə/ vs. /a/ in initial syllables			
bəgdi	‘leg’	baksı	‘bundle’
gə:ni	‘steel (adj.)’	va:mı	‘thick’
bəsu	‘place, site’	garu	‘leggings’
gə:xunə	‘cleanly’	ba:pə	‘pack, bunch’
bəbəkə	‘child’s swing’	vaqa	‘good’
kə:lə	‘fast’	qa:qta	‘cranberries’

A summary of the restricted distribution of nonhigh rounded vowel /ɔ/ in Ulchi is as follows:

(67) Summary of Ulchi labial harmony (Walker, 2001)

- a. Triggers are nonhigh round vowels in the initial syllable; targets are also nonhigh, and round nonhigh vowels never occur after an unrounded vowel. Well-formed structures include [Cɔ(:)Cɔ], [Ca(:)Ca], but not \*[Cɔ(:)Ca], \*[Ca(:)Cɔ],
- b. High vowels block round harmony; after a high vowel, a nonhigh vowel is unrounded, i.e., [Cɔ(:)CɪCa] and [Cɔ(:)CʊCa] are well-formed, but not \*[Cɔ(:)CɪCɔ], \*[Cɔ(:)CʊCɔ].

The distribution of /ɔ/ summarized above is illustrated in the following examples:

(68) RTR words (first syllable contains /ɔ/) (Kaun, 1995, p. 77)

- a. bɔ:nɔ           ‘hail (weather)’
- gɔrɔ           ‘far’

	təŋdɔ	‘straight ahead’
	tətəŋgɔ	‘multi-colored’
b.	vɔlmɪ	‘long’
	gɔ:lɪ	‘wide, broad’
	bɔ:dɔ	‘insufficiently’
	kɔ:rɔʧɔvɔ	‘to regret’
	dʒɔŋbɔlɔvɔ	‘to prick, stab’

(69) High vowels block labial harmony (Kaun, 1995, p. 77)

a. Blocking by /ɪ/

ɔjɪlavɔ	*ɔjɪlɔvɔ	‘leggings’
ɔmɪrɔ	*ɔmɪrɔ	‘uterus’
ɔrkɪqtalɔ	*ɔrkɪqtɔlɔ	‘uncomfortably’
dɔ:kɪlɔ	*dɔ:kɪlɔ	‘inside’

b. Blocking by /ʊ/

bɔlɔdʒɔvɔmɪ	*bɔlɔdʒɔvɔmɪ	‘as soon as it becomes Autumn’
kɔ:vɔlɔvɔ	*kɔ:vɔlɔvɔ	‘to raise a mast’
kɔrɔkɔ	*kɔrɔkɔ	‘pike (fish) skin’

Note that /ɔ/ is spreading its [+RTR] value even when labial spreading is blocked.

This indicates that [RTR] takes scope over [labial].

#### 4.2.2.4. Uilta

Uilta (Ujlta, Ulta; Orok, Oroc), spoken in the Poronajsk and Nogliki, Sakhalin, Russia by 64 speakers out of 346 ethnic Oroks (Russian census, 2002), has the following

vowel system. Following Ikegami (1955), I assume the phonemic distinction between /i/ and /ɪ/, /u/ and /ʊ/<sup>85</sup>:

(70) Uilta vowels (based on Ikegami, 1955, pp. 466–470)

i	i:	u	u:
ɪ	ɪ:	ʊ	ʊ:
	e:	ə ə:	o o:
	ɛ:	a a:	ɔ ɔ:

(See also Hattori, 1975, p. 10, 1982, p. 212)

[e] and [ɛ] only appear as long vowels, [e:] and [ɛ:], and thus can be assumed to derive from /i (+) ə/ and /i (+) a/ respectively (Hayata, 1979, p. 129). Examples are as follows:

(71) [e:] and [ɛ:] derive from /i (+) ə/ and /i (+) a/, respectively (based on Hayata, 1979)

‘bucket’ +ACC	‘person’ +ACC	
/koččooli + ba/	/nari + ba/	UR
koččoolli + a	narri + a	ba-fusion <sup>86</sup>

<sup>85</sup> This “hypothesized” phonemic distinction between /i, u/ vs. /ɪ, ʊ/ in Ikegami (1955) was disfavored soon by himself (Ikegami, 1956 et seq.). Kazama (2003, p. 15) and Tsumagari (2009a, pp. 2–3) all accept Ikegami’s postulation of /i, u/ as neutral vowels. However, according to Ikegami (1997, p. xii–xiv), [ɪ] and [ʊ] do exist in Orok as allophones of these putative ‘neutral’ vowel /i/ and /u/ when followed by /a, o/.

<sup>86</sup> Based on Ikegami’s (1956, p. 79) observation on the various changes involving the noun stem ending in CV followed by the accusative marker, e.g., \*(-)VCa-ba > (-)VCCaa, \*(-)VCo-bo > (-)VCCoo, \*(-)Vcu-ba > (-)VCCoo, \*(-)VCi-ba > (-)VCCee, \*-CCa-ba > -CCaa, \*-CCo-bo > -CCoo, \*-CCu-ba > -CCoo, \*CCi-ba > -CCee, and many other similar changes, Hayata formalized the following synchronic rule:

ba-fusion: C V + b a → 1 1 2 3 ∅ 5  
                   1 2 3 4 5

koččoollī + ə	-----	vowel harmony
koččo:lle:	narrɛ:	vowel contraction
[koččo:lle:]	[narrɛ:]	SR

The contrastive hierarchy I propose for Uilta is as follows:

(72) Contrastive hierarchy for Uilta

- a. SDA: [low] > [coronal] > [labial] > [RTR] (or [RTR] > [labial])

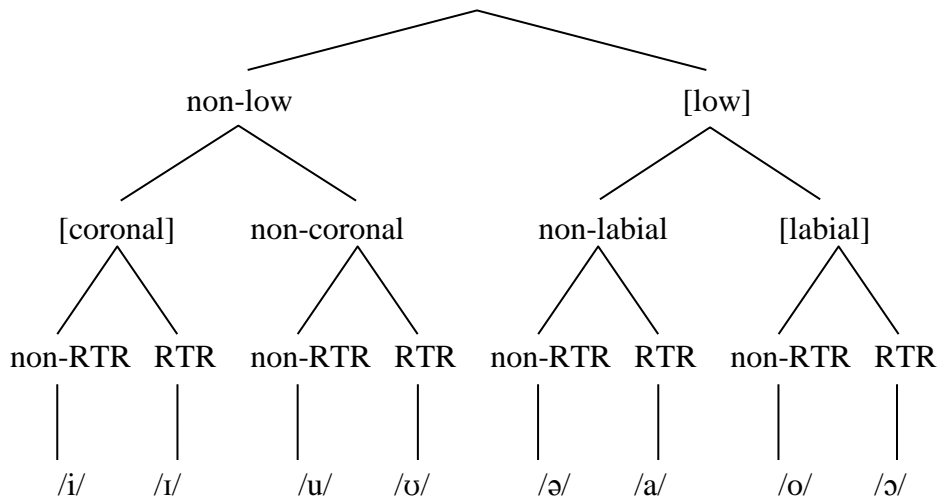

- b. Output specification

examples:	ba-fusion	other rules
/nari+ba/	→ narri+a	→ [narrɛ:]
/utə+ba/	→ uttə+a	→ [uttə:]
/koodo+ba/	→ kooddo+a	→ [ko:ddo:]
/sinu+ba/	→ sinnu+a	→ [šinno:]
/koččoollī+ba/	→ koččoollī+a	→ [koččo:lle:]
/mərəkə+ba/	→ mərkkə+a	→ [mərəkə:]
/xokto+ba/	→ xoktto+a	→ [xokto:]
/xupikku+ba/	→ xupikkku+a	→ [xupikko:]
/bəgdi+ba/	→ bəgddi+a	→ [bəgje:]

Surely, this ba-fusion rule overgenerates impossible consonant clusters (in the last four examples: e.g., xoktto+a) which should be repaired by additional rule (e.g., cluster simplification).

/i/ = [-low, +cor, -RTR]	/u/ = [-low, -cor, -RTR]
/ɪ/ = [-low, +cor, +RTR]	/ʊ/ = [-low, -cor, +RTR]
/ə/ = [+low, -lab, -RTR]	/o/ = [+low, +lab, -RTR]
/a/ = [+low, -lab, +RTR]	/ɔ/ = [+low, +lab, +RTR]

Note that this hierarchy will still hold for the reduced system proposed by Ikegami (1956, fn. 1) and followers: the reduced system lost (or is losing) the minimal contrast between /i/ and /ɪ/ and between /u/ and /ʊ/ based on the feature [RTR]. (This scenario will work under the hierarchy [RTR] > [labial] too, since [labial] is only contrastive among low vowels and, hence, [RTR] would be the lowest feature for non-low vowels.)

The contrastive hierarchy is supported by the vowel-related phonological patterns such as palatalization, RTR and labial harmony, and blocking effect. First, according to Tsumagari (2009a, p. 2), the nasal /n/ is palatalized before /i, ε/ and the alveolars /t, d/ usually do not occur before /i, ε/. This means that /i, ɪ/ must bear a palatalizing feature specification underlyingly. (Recall that /ɪ/ is presumed as a phoneme distinguishable from /i/ and that the underlying representation of [e:] and [ɛ:] is assumed to be /i (+) ə/ and /i (+) a/, respectively (Hayata, 1979, p. 129)).

Second, the following examples show the vowel harmony pattern in Uilta:

(73) Uilta vowel harmony (Ikegami, 1959, 2001)

Stem	-dAIAA ‘until-’ <sup>87</sup>	
a. ɲənə-	ɲənə-dələə	‘to go’

<sup>87</sup> “Terminative converb” ending (Tsumagari, 2009a, p. 9); “an action until the occurrence of which another action continues” (Ikegami, 2001, p. 29, originally 1959).

	baa-	baa-dalaa	‘to find, to see [a person]’
b.	un-	un-dələə	‘to say’
	ʊʊ-	ʊʊ-dalaa	‘to ride’
c.	xool-	xool-doloo	‘to spill, to empty’
	lɔɔ-	lɔɔ-dɔlɔɔ	‘to hang’

The above data show the opposition between “closed” vs. “open” vowels (Hattori, 1975, 1982; Tsumagari, 2009a) which is also often called “hard” vs. “soft” vowels (Kazama, 2003, p. 15).

(74) Uilta vowel classes

- a. “closed” (“hard”) vowels: /i, ə, u, o/
- b. “open” (“soft”) vowels: /ɪ, a, ʊ, ɔ/

Considering similar vowel harmony patterns we have seen so far, Uilta vowel harmony can now be interpreted as RTR harmony, although it has been characterized as “height” harmony (Hayata, 1979, p. 135). Evidence in favor of an RTR analysis comes from the velar-uvular alternation.

(75) Velar-uvular alternation (Ikegami, 1997, p. xiv–xv)

- a. [k ~ q]
 

/koodo/	[ko:do]	‘bellows’	/ɔktɔ/	[ɔqtɔ]	‘drug’
---------	---------	-----------	--------	--------	--------
- b. [g ~ ɣ]
 

/giləə/	[gilə:]	‘Nivkh people’	/taagda/	[ta:ɣda]	‘white’
---------	---------	----------------	----------	----------	---------
- c. [ʏ ~ ɤ]
 

/əɣə/	[əʏə]	‘young woman’	/ačiga/	[aʃɪɤa]	‘rat’
-------	-------	---------------	---------	---------	-------

d. [x ~ χ]

/xəjə/ [xəjə] ‘flow, stream’ /xajə/ [χadʒa] ‘scissors’

Note also that Uilta has labial harmony which is triggered only by low rounded vowels /o, ɔ/ (compare (73)b and (73)c above).

As in other Tungusic languages, all high vowels including /i, ɪ/ and /u, ʊ/ block labial harmony:

(76) /i, ɪ/ block labial harmony (Ikegami, 1959, 2001)

- |    |       |                           |                      |
|----|-------|---------------------------|----------------------|
| a. | mɔɔɪ- | mɔɔɪ-dalaa                | ‘to gather firewood’ |
| b. | boo-  | boo-ri-lləə <sup>88</sup> | ‘to give’            |
|    | ɔɔɔg- | ɔɔɔg-ʃɪ-llaa              | ‘to carry’           |

(77) /u, ʊ/ block labial harmony (Ikegami, 1956)

- |    | ACC   | LOC                    |                           |                          |
|----|-------|------------------------|---------------------------|--------------------------|
| a. | xokto | xokto-o                | xokto-lo                  | ‘a kind of coat’         |
| b. | soon  | soom <sup>89</sup> -bo | soon-du <sup>90</sup> -lə | ‘fur overcoat’           |
|    | bojol | bojol-bo               | bojol-du-lə               | ‘undomesticated mammals’ |

Despite the co-occurrence restrictions of vowels imposed by harmony, Uilta seems to allow /a, ʊ/ and /ə, u/ to be followed by /ɔɔ/ and /oo/, but apparently not by /ɔ/ and /o/

---

<sup>88</sup> The meaning of *-ri* is “an unfinished action, the doer(s) or the undergoer(s) of an unfinished action, or a place in space or a period in time where an unfinished action occurs” (p. 28); *-llaa* has “a meaning identical with that of *-la-* [‘the occurrence of an action in the future’] plus the meaning ‘the subject = the third-person’” (p. 33).

<sup>89</sup> /n/ surfaces as [m] before /b/ (“n-m conversion” rule, Hayata, 1979, p. 155).

<sup>90</sup> “Locative *-la/* is preceded by [du] if the preceding noun ends in a consonant.” (Hayata, 1979, p. 137)



(Ikegami, 1956, fn. 1, 1997, p. xvi; Tsumagari, 2009a, p. 3). This is illustrated with examples with designative and comitative markers below:

(78) Examples of two-way alternations in suffixes (between *oo* and *oo*)

a. Designative marker: -ddoo ~ -ddoo

utə	utə-ddoo	‘doorway-Designative’
mərkə	mərkə-ddoo	‘fine-toothed comb-Designative’
bεε <sup>91</sup>	bεε-doo	‘place in a dwelling-Designative’

c. Comitative marker: -ndoo ~ -ndoo

puttə	puttə-ndoo	‘child-Comitative’
patala	patala-ndoo	‘girl-Comitative’

The appearance of [o:] and [ɔ:] in the above suffixes cannot be viewed as the result of labial harmony since none of the above stems contains a trigger vowel (/o/ or /ɔ/).

The following examples also support this point:

(79)	koččooli	koččooliddoo	‘bucket-Designative’
	dooxtəri	dooxtərindoo	‘doctor (physician)-Comitative’

Since /i/ blocks labial harmony (e.g., koččoolilə (\*koččoolilo) ‘bucket-Locative’), the expected designative form is unattested \**koččooliddəə*, rather than the attested *koččooliddoo*.

---

<sup>91</sup> This is postulated as /bee/ in Ikegami (1956, Table I).

Hayata (1979) postulates /du + ba/ and /ndu + ba/ as the underlying form of the designative and the comitative marker, respectively, and shows in the following rule-based derivations that the appearance of [o:] and [ɔ:] is the result of vowel contraction:

(80) Derivations of *utə-ddoo* and *patala-ndɔɔ* (Hayata, 1979, (37) & (39))

utə-ddoo	patala-ndɔɔ	
/utə+ du+ba/	/patala+ ndu+ba/	UR
utə+ ddu+a	patala+ nddu+a	ba-fusion
-----	patala+ ndu+a	cluster simplification
utə+ ddu+ə	-----	vowel harmony
utə+ ddo:	patala+ ndɔ:	vowel contraction
[utəddo:]	[patalandɔ:]	SR

Now we have two different sources for SR [o] and [ɔ] in suffixes: those driven from labial harmony (e.g., /poron+ba/ → [porombɔ]) and those driven from vowel contraction (e.g., /sinu+ba/ → sinnu+a → sinnu+ə → [šinno:]). This is illustrated by the following rule-based derivation:

(81) Accusative marker: -bA (Hayata, 1979, p. 136)

/poron+ba/	/sinu+ba/	/koččooli+ba/	UR
-----	sinnu+a	koččooli+a	ba-fusion
poron+bə	sinnu+ə	koččooli+ə	vowel harmony
poron+bo	-----	-----	rounding assimilation
-----	sinno:	koččo:lle:	vowel contraction
porom+bo	šinno:	-----	other rules
[porombo]	[šinno:]	[koččo:lle:]	SR

‘thumb’      ‘tongue’      ‘bucket’

If correct, this analysis predicts a behavioral difference between the two types of long low rounded vowels: (i) those driven from labial harmony are predicted to further spread their [+labial] value to the following low vowels as long as the spreading is not blocked by a high vowel; (ii) those driven from vowel contraction of /u+ə/ or /ʊ+a/ sequences are predicted not to trigger labial harmony since none of the constituent vowels is specified with a contrastive [+labial] value. Unfortunately, I was not able to find any examples that show whether this prediction is borne out or not.

#### 4.2.2.5. Nanai

According to Sem (Sem, 1976, p. 26, as cited in D. Ko & Yurn, 2011), Nanai has three dialects, Upper, Middle, and Lower Amur, as follows:

- (82) Nanai dialects (Sem, 1976, p. 26, as cited in D. Ko & Yurn, 2011)<sup>92</sup>
- a. Upper Amur:      Sunggari, Right-bank Amur, Bikin, Kur-Urmi
  - b. Middle Amur:      Sakachi-Aljan, Najkhin, Dzhujen
  - c. Lower Amur:      Bolon, Ekon, Gorin

Here we will discuss Najkhin dialect described in Avrorin (1958, 1959), as cited in J. Kim (1988b, 1993), and D. Ko & Yurn (2011). The basic characteristics of Nanai vowel phonology observed by Avrorin in 1950s are confirmed by the fieldwork research conducted in 2005 and 2006 by D. Ko & Yurn.

---

<sup>92</sup> See An (1986) and Zhang et al. (1989 for Kilen dialect of Hezhe) for descriptions on Hezhe (赫哲), the Nanai language spoken in China.

Najkhin Nanai has the following 6-vowel system:

- (83) Nanai vowels (Avrorin, 1959; J. Kim, 1988b; D. Ko & Yurn, 2011, p. 19; B. Li, 1996)<sup>93</sup>
- i   ə   u
- ɪ   a   ʊ<sup>94</sup>

D. Ko & Yurn (2011) presents the following formant chart for Najkhin Nanai vowels:<sup>95</sup>

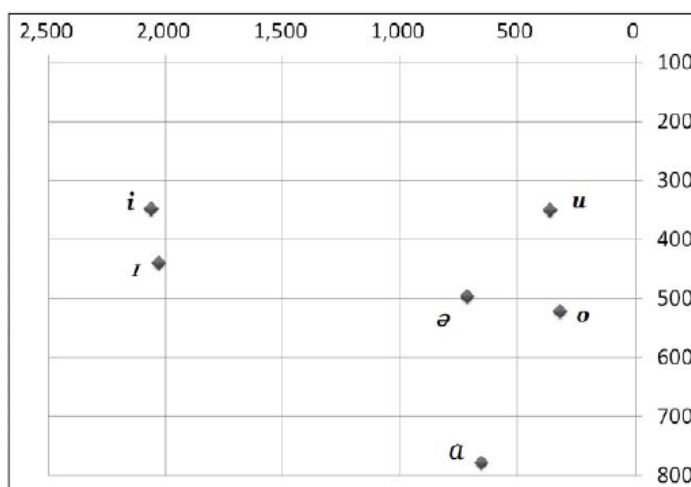

Figure 7. Formant chart of Najkhin Nanai vowels (D. Ko & Yurn, 2011, p. 21).  
Vertical axis: F1, horizontal axis: F2-F1.

<sup>93</sup> Although vowel length distinction is contrastive, it will be ignored here.

<sup>94</sup> In place of /o/ (Avrorin, 1959; J. Kim, 1988b; D. Ko & Yurn, 2011), I use /ʊ/ (à la B. Li, 1996) and modify the examples accordingly. I also replace /j, c/ in D. Ko & Yurn (2011) with /tʃ, ʃ/. Long vowels are marked with two consecutive vowel symbols, i.e., /VV/, rather than with a macron “ $\bar{\text{v}}$ ” or the IPA length mark “:” (or a colon as a typographical alternative).

<sup>95</sup> The formant values of the vowels in this chart should be only taken as rough estimations, since only four tokens for each vowel were measured.

Inventory-wise, Nanai lacks the distinction between high and low rounded vowels which is widely attested in many other Tungusic (as well as Mongolic) languages. Li (1996) suggests that earlier Nanai had four back rounded vowels \*u, \*ʊ, \*o, \*ɔ which have reduced to /u, ʊ/ by means of the merger of \*u, \*o > /u/ and \*ʊ, \*ɔ > /ʊ/. These suggested merger patterns, however, seem to require further investigation to be proven to be true.

The contrastive hierarchy I propose for Nanai is as follows:

(84) Contrastive hierarchy for Nanai

- a. SDA: [low] > [coronal] > [RTR]

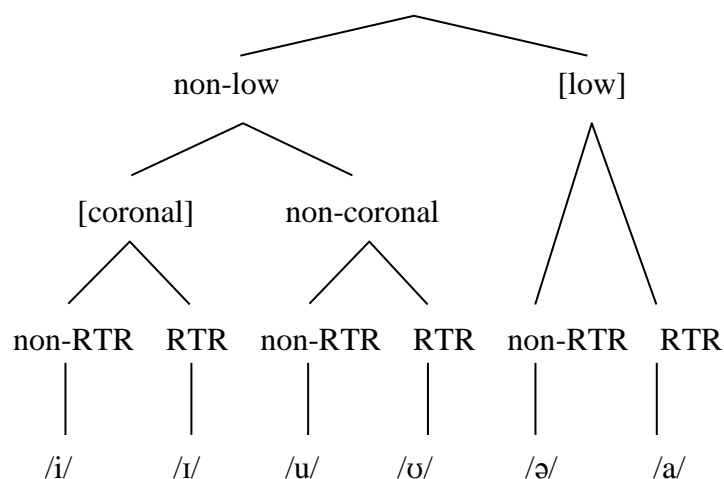

b. Output specifications

/i/ = [-low, +cor, -RTR]

/u/ = [-low, -cor, -RTR]

/ɪ/ = [-low, +cor, +RTR]

/ʊ/ = [-low, -cor, +RTR]

/ə/ = [+low, -RTR]

/a/ = [+low, +RTR]

The above hierarchy which exploits three contrastive features, [coronal], [RTR], and [low], shows a remarkable resemblance to the hierarchy [low] > [coronal] > [RTR] >

[labial] I proposed for other Southern Tungusic languages such as Written Manchu and Oroch. The only difference is the absence of [labial] in the Nanai system. This is a desirable result from a genealogical/typological viewpoint.

First, palatalization indicates that the feature [coronal] is contrastive. The trigger vowels, /i, ɪ/, must bear [+coronal] specification.

(85) Palatalization: /s, x, n/ surface as [ç, ç, ɲ] before /i, ɪ/ (D. Ko & Yurn, 2011).<sup>96</sup>

- |    |           |           |                |
|----|-----------|-----------|----------------|
| a. | /sɨŋgərə/ | [çɨŋgərə] | ‘mouse’        |
|    | /sɨŋakta/ | [çɨŋakta] | ‘fur’          |
|    | /asi/     | [aɕi]     | ‘wife’         |
| b. | /guluxin/ | [guluçɨ]  | ‘soot’         |
| c. | /nimøkta/ | [ɲimøkta] | ‘tear’         |
|    | /niməkən/ | [ɲiməkɛ]  | ‘neighborhood’ |
|    | /onıkan/  | [onıqã]   | ‘brook’        |

The contrastive status of [RTR] is evidenced by the following vowel harmony pattern.

(86) Vowel harmony in Nanai (J. Kim, 1993, p. 200; D. Ko & Yurn, 2011, p. 26)

- | Non-RTR stems |              | RTR stems       |                        |                  |
|---------------|--------------|-----------------|------------------------|------------------|
| a.            | əsitul       | ‘immediately’   | nımöksa                | ‘tear’           |
| b.            | puŋku-wə     | ‘shawl-ACC’     | dʒıxa-wa <sup>97</sup> | ‘money-ACC’      |
| c.            | pulsi-xəm-bi | ‘go-P_PST-1SNG’ | dʒatɔ-xam-bı           | ‘hit-P_PST-1SNG’ |

<sup>96</sup> Vowel lengthening in word-final position (D. Ko & Yurn, 2011, p. 23) is not reflected in the phonetic transcription of these examples.

<sup>97</sup> *dʒıxa* ‘money’ and *dʒatɔ-xam-bı* ‘hit-P\_PST-1SNG’ are transcribed as *jıxa* and *jato-xam-bı*, respectively, in D. Ko & Yurn (2011). I believe the *i* in these examples is simply a typo for *ɪ*, judging from the relevant description.

d. bəgdʒi-dulə ‘foot-INST’                      nasal-dula ‘eye-INST’

According to the above patterns, Nanai vowels are divided into two groups: [-RTR] vowels /i, ə, u/ and [+RTR] vowels /ɪ, a, ʊ/. There is no neutral vowel.

Since each harmonic pair (/i, ɪ/, /ə, a/, and /u, ʊ/) shows some noticeable height difference, the Nanai vowel harmony may well be treated as a height harmony involving [low] as the harmonic feature. However, as J. Kim (1993, pp. 195–9) points out, a height harmony analysis is disfavored when the phonetic realization of vowels described in Avrorin (1959, pp. 18–19) is taken into consideration. First, /ə/, which would be treated as a “high” vowel in a height harmony analysis, is realized lower than (or at least as low as) the “low” vowels /ɪ, ʊ/. Second, according to Avrorin, the two vowels in a harmonic pair are realized with a noticeable difference in their relative frontness as well as the relative height difference. A height harmony analysis cannot explain this front-back difference, whereas a tongue root analysis will explain it as the result of a concomitant tongue body movement accompanying the tongue root advancing/retraction (Lindau, 1974; Archangeli & Pulleyblank, 1994, among others).

Evidence shows that [RTR], rather than [ATR], is the dominant feature in Nanai. First of all, as in many other Tungusic (as well as Mongolic) languages, Nanai has velar-uvular alternations conditioned by the tautosyllabic vowels. Since uvulars are marked, we view that RTR vowels are also marked.

(87) Velar-uvular alternation (Avrorin, 1959, p. 36; J. Kim, 1988b, p. 234)<sup>98</sup>

Non-RTR words

RTR words

---

<sup>98</sup> Examples from Avrorin (1959, p. 36) are marked with superscript ‘A59’; Examples from J. Kim (1988b, p. 234) are originally from Avrorin (1958).

a.	k : q				
	[əktə]	‘woman’	[ʊqtʊ]	‘drug’	
	[dʒukə]	‘ice’	[dʒaqa]	‘thing; treasure’	
b.	g : ɠ				
	[əgə]	‘elder sister’	[aga]	‘elder brother’	
	[gufi] <sup>A59</sup>	‘yet, still’	[ɠorʊ]	‘distant’	
c.	x : χ				
	[xəsə]	‘language’	[χasar] <sup>A59</sup>	‘wing’	
	[xulu]	‘chipmunk’	[lʊχʊ]	‘sword’	
d.	ŋ : N				
	[dəŋsə]	‘scale’	[dansa]	‘book’	
	[tʊŋgən] <sup>A59</sup>	‘breast’	[aŋga] <sup>A59</sup>	‘net’	

This view is also confirmed by the (optional) positional neutralization which takes place usually in word-final positions (but sometimes in non-initial syllables as well).

(88) “Weakening” of [+RTR] vowels to [-RTR] vowels in final syllables<sup>99</sup>

a. Avrorin (1959, p. 69), as cited in J. Kim (1988b, 1993)

/namʊ/

/xadʒʊn/

---

<sup>99</sup> The weakening from /ʊ/ to /u/ is not always possible. /ʊ/ is more likely preserved (i) after another /ʊ/, (ii) after a uvular consonant, and (iii) in the context where its neutralizing with /u/ would jeopardize correct perception of the entire word as an RTR one:

Preservation of /ʊ/ in word-final position (Avrorin 1958, p. 146, as cited in J. Kim 1988, 1993)

i.	ʊmʊ	‘band, sash’	bʊʊ	‘autumn’
	bʊsʊ	‘cloth’	dʒʊgbʊ	‘harpoon’
ii.	xadʊkʊ	‘sickle, scythe’	darakʊ	‘a brazen person’
iii.	nɪmʊ	‘a kind of saemon’	gɪrsʊ	‘knife (used by women)’



[nam <u>u</u> ]	‘sea’	[χad <u>ʒ</u> un]	‘equipment; inventory’ <sup>100</sup>
[nam <u>u</u> -du]	‘sea-LOC’	[χad <u>ʒ</u> un-di]	‘equipment-INST’
[nam <u>u</u> -d <u>u</u> -ani]	‘sea-LOC-POSS.REFL’		

b. Avrorin (1958), as cited in J. Kim (1988b, p. 237, 1993, p. 201)

kotol <u>i</u> ~ kotol <u>i</u>	‘sail’
damax <u>i</u> ~ damax <u>i</u>	‘cigarette’
torak <u>i</u> ~ torak <u>i</u>	‘crow’ (cf. /gaaki/ in D. Ko & Yurn, 2011, p. 91)
xadu ~ xadu	‘amount/quantity; how many/how much’
xaŋ <u>g</u> u ~ xaŋ <u>g</u> u	‘carp’
da <u>s</u> u <sup>n</sup> ~ da <u>s</u> u <sup>n</sup>	‘salt’
gama <u>s</u> u <sup>n</sup> ~ gama <u>s</u> u <sup>n</sup>	‘niece’ (cf. “cousin” in D. Ko & Yurn, 2011, p. 92 ) <sup>101</sup>

Two things should be noted. First, this “weaking” is uni-directional: [+RTR] vowels /i/ and /u/ become [-RTR] vowels [i] and [u], but not vice versa. This indicates that [+RTR] is the marked value. Second, the low vowels /a/ and /ə/ do not participate in this final weakening. That is, /a/ is not weakened to [ə]. This serves as evidence for the contrastive status of [low].

Given that both [low] and [RTR] are active in Nanai, the weakening pattern can be explained in terms of the antagonistic feature combination between [-low] (= [+high]) and [+RTR] (Archangeli & Pulleyblank, 1994; cf. Joseph & Whitman, 2012) by which high RTR vowels such as /i/ and /u/ are disfavored, whereas low RTR vowel /a/ is, on the contrary, tolerated (if not favored).

<sup>100</sup> According to Ko & Yurn (2011, p. 135), the meaning is ‘property’ or ‘thing.’

<sup>101</sup> Cf. /piktərən/ ‘nephew; niece’ (D. Ko & Yurn, 2011, p. 118)

Note that all the six Nanai vowels are exhaustively distinguished with the three contrastive features [coronal], [RTR], and [low]. No further contrastive feature is required. In particular, the feature [labial], which is contrastive in other Tungusic languages we have seen so far, is redundant in Nanai. This is consistent with the fact that Nanai has no labial harmony.<sup>102</sup>

Alternative contrastive hierarchies may employ [labial]. For example, a height harmony analysis would suggest [low] > [coronal] > [labial]. Under this hierarchy, with no way to distinguish /ə, a/ from /i, ɪ, u, ʊ/, the final weakening can only be understood as height neutralization. Then, nothing would prevent /a/ from patterning together with /ɪ/ and /ʊ/ and it would be predicted that it be raised to [ə] in word-final positions. However, this prediction is contradictory to the attested pattern. In a similar vein, an RTR harmony analysis (e.g., [coronal] > [labial] > [RTR]) which excludes a contrastive [low] would face the same problem.

The proposed hierarchy [low] > [coronal] > [RTR] in (84) is supported by other Nanai dialects. First, let us take a look at the following examples.

---

<sup>102</sup> Since there is no labial harmony, the vowel alternation in suffixes and endings is confined to an RTR harmonic pair: e.g., /i/~ɪ/ as in the converb ending *-mi/-mɪ*, /ə/~a/ as in the diminutive suffix *-kən/-qan*, or /u/~ʊ/ as in the Instrumental suffix *-dulə/-dʊla*. There is, however, a trace of labial harmony in the case of the derivative suffix with collective meaning: *-ktə ~ -kta ~ -ktʊ*:

Derivative suffix with collective meaning: *-ktə ~ -kta ~ -ktʊ* Avrorin (Avrorin, 1958, as cited in J. Kim 1993)

- |      |           |                      |                                      |
|------|-----------|----------------------|--------------------------------------|
| i.   | ɟʒiə-ktə  | ‘Siberian millet’    |                                      |
|      | nu-ktə    | ‘hair’               |                                      |
| ii.  | garma-kta | ‘mosquito’           |                                      |
|      | ɲamʊ-kta  | ‘tear’               | nɪmʊkta (Ko & Yurn 2011, p. 111)     |
| iii. | ɟʒʊrʊ-ktʊ | ‘temple (body part)’ |                                      |
|      | bʊlʊ-ktʊ  | ‘a kind of shrub’    |                                      |
|      | kʊŋgʊ-ktʊ | ‘hand bell’          | kʊŋgʊktʊkan (Ko & Yurn 2011, p. 104) |
|      | kʊrʊ-ktʊ  | ‘auricle’            |                                      |

Although this derivative suffix may not be synchronically productive, it may suggest that at an earlier stage, Nanai may have had labial harmony (Avrorin, 1958, as cited in J. Kim, 1993, p. 201; see also B. Li, 1996, p. 148).

- (89) Correspondence between /i/ in Kur Nanai and Hezhen and /u/ in Najkhin and Bikin Nanai (J. Kim 1993, p. 206)

Kur	Hezhen	Najkhin	Bikin	Gloss
tiŋə <sup>n</sup>	tiŋən	tujə <sup>n</sup>	tujə <sup>n</sup>	‘breast’
tigdə	tigdə	tugdə	tugdə	‘rain’
iktəl	ixtələ	xuktə	xuktələ	‘tooth’
imnə	irmən	xurmə	xurmə	‘needle’

The above data show that the vowel /i/ in some lexical items in Najkhin and Bikin varieties correspond to /u/ in Kur(-Umi) Nanai and Hezhen. I do not have any conclusive presumption on the nature of this correspondence, but here I simply assume that it is a decoronalization triggered by /ə/ in the following syllable. No matter what the mechanism of this phenomenon is, my question is how the two vowels are directly related to each other.

The contrastive hierarchy I proposed ([low] > [coronal] > [RTR]) gives an answer: /i/ and /u/ directly contrast with each other in terms of [coronal]. However, in alternative hierarchies with both [coronal] and [labial] and without either [low] or [RTR], /i/ and /u/ cannot be directly related to each other: rather, /i/ and /ə/, or /u/ and /ə/, depending on the relative ordering between [coronal] and [labial], are in such a relation. For instance, if [labial] takes scope over [coronal], [labial] would divide /i, ə, u/ into two sets /i, ə/ and /u/ first. Then [coronal] would divide the rest into /i/ and /ə/. Under this hierarchy, if the above phenomenon is really a decoronalization triggered by /ə/, we would anticipate /i/ to become /ə/, not /u/.

Finally, we find a merger of  $i > i$  in Hezhen (An, 1986, as cited in J. Kim, 1993, p. 209). This can be viewed as evidence in favor of ranking [RTR] at the bottom of the hierarchy (at least lower than [coronal]) with regard to the Minimal Contrast Principle.

#### 4.2.3. *Northern Tungusic languages*<sup>103</sup>

##### 4.2.3.1. Oroqen

###### 4.2.3.1.1. *Xunke Oroqen*

A contrastive hierarchy analysis of Oroqen has already been proposed by X. Zhang (1996). Here I simply introduce X. Zhang's data and analysis, starting with the following seven vowel phonemes he proposed:

(90) Xunke Oroqen vowels (X. Zhang, 1996, p. 161)

i	u
	ʊ
ə	o
a	ɔ

In addition to these seven basic vowels, there are also low front vowel qualities [e, ε]. However, these are considered to exist only as long vowels (X. Zhang 1996, pp. 167-8).

X. Zhang (1996) proposes the following contrastive hierarchy for Oroqen:

---

<sup>103</sup> See B. Li (1996, pp. 21–25) for a classification issue (cf. de Boer, 1996; Whaley et al., 1999). See B. Li (1996, pp. 23–24) and X. Zhang (1996) for the relations among Ewenki, Oroqen, and Solon.

(91) Contrastive hierarchy for Xunke Oroqen (X. Zhang 1996, p. 161)

a. SDA: [low] > [coronal] > [labial] > [RTR]<sup>104</sup>

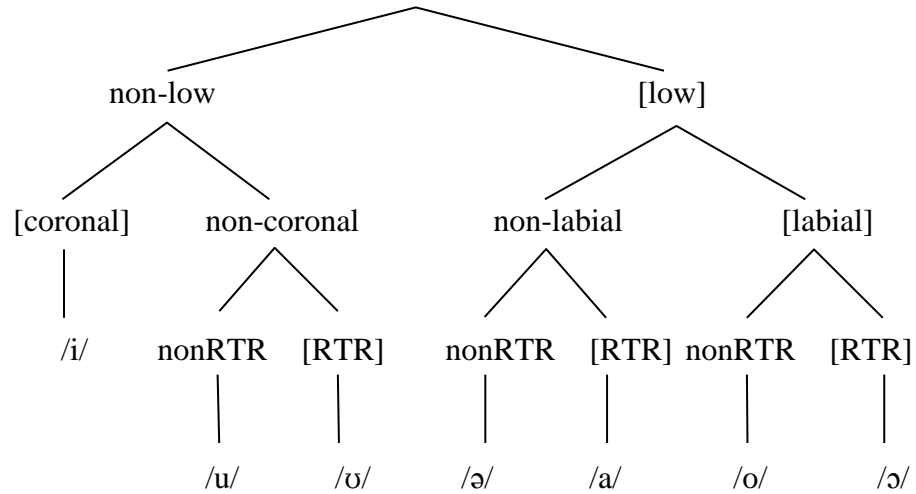

b. Output specifications

/i/ = [-low, +cor]

/u/ = [-low, -cor, -RTR]

/ʊ/ = [-low, -cor, +RTR]

/ə/ = [+low, -cor, -lab, -RTR]

/o/ = [+low, -cor, +lab, -RTR]

/a/ = [+low, -cor, -lab, +RTR]

/ɔ/ = [+low, -cor, +lab, +RTR]

The above contrastive hierarchy is justified by various phonological patterns such as RTR harmony, labial harmony, palatal glide formation, and labial glide formation.

First, the contrastive status of [RTR] is evidenced by RTR harmony.

(92) RTR harmony in Xunke Oroqen (data drawn from X. Zhang 1996, p. 177ff.)

non-RTR stems

RTR stems

<sup>104</sup> The relative hierarchy between [labial] and [RTR] may be preferable considering the proposed contrastive hierarchies for other Tungusic languages. However, I will not attempt a revision of X. Zhang's hierarchy here.

- a. General present tense marker: - rə/ra(/ro/rə)
- |         |            |          |                 |
|---------|------------|----------|-----------------|
| bəju-rə | ‘to hunt’  | jabu-ra  | ‘to walk’       |
| sərə-rə | ‘to awake’ | aldza-ra | ‘to be ashamed’ |
- b. Definite object case marker: - wə/wa(/wo/wə)
- |           |            |           |         |
|-----------|------------|-----------|---------|
| bəjun-mə  | ‘moose’    | urɔun-ma  | ‘hoof’  |
| ulgulu-wə | ‘language’ | dzaaka-wa | ‘thing’ |
- c. Plural marker: -səl/sal(/sol/səl)
- |          |          |           |           |
|----------|----------|-----------|-----------|
| bəjə-səl | ‘person’ | təwa-sal  | ‘soldier’ |
| ukur-səl | ‘cow’    | mɔrin-sal | ‘horse’   |
- d. Diminutive marker: - tɛərə/tɛara(/tɛoro/tɛɔrə)
- |               |        |             |        |
|---------------|--------|-------------|--------|
| nəktə-tɛərə   | ‘low’  | daa-tɛara   | ‘near’ |
| urumkun-tɛərə | ‘high’ | sunta-tɛara | ‘deep’ |
- e. Dative case marker: -du/dʊ
- |          |                 |          |         |
|----------|-----------------|----------|---------|
| utə-du   | ‘son’           | bowa-dʊ  | ‘place’ |
| boodo-du | ‘kitchen knife’ | dɔlbɔ-dʊ | ‘night’ |

Although it is phonetically [-RTR], /i/ can co-occur with either non-RTR or RTR vowels (93)a,b and is transparent to RTR harmony (93)c. Thus, /i/ lacks contrastive specification for [RTR].

(93) The neutrality of /i/ (data drawn from X. Zhang 1996, pp. 157-6)

non-RTR stems

RTR stems

- a. /i/ can co-occur with either non-RTR or RTR vowels in a stem.

nəkin	‘to sweat’	tari	‘that’
ulin	‘betrothal gifts’	mɔrin	‘horse’
bitə	‘letter’	birakan	‘river’

b. A suffix with /i/ is attached to both non-RTR and RTR stems.

sukə-dzi	‘axe-INST’	tokala-dzi	‘clay-INST’
kədərə-dzi	‘knife-INST’	moo-dzi	‘wood-INST’

c. /i/ is transparent to RTR harmony.

nəkin-nə	‘sweat-PAST’	tari-wa	‘that-DEF.OBJ’
ulin-mə	‘betrothal gifts-DEF.OBJ’	mōrin-ma	‘horse-DEF.OBJ’

If the neutral vowel /i/ is the only stem vowel, non-RTR suffix is selected.

(94) Stems with only /i/ take non-RTR suffixes (data drawn from X. Zhang 1996, pp. 158-9)

il-lə	‘to stand-PAST’	ir-rə	‘to ripen-PAST’
tik-tə	‘to fall-PAST’	lipki-rə	‘to block up-PAST’
irgi-wə	‘tail-DEF.OBJ’	iŋŋi-wə	‘tongue-DEF.OBJ’

This indicates that non-RTR is the default, unmarked value of the harmonic feature, justifying the RTR analysis.

However, B. Li (1996, p. 143) conducted fieldwork on the same variety in 1994 and found that there is inconsistency: some neutral roots take an RTR suffix.

(95) Idiosyncrasy of neutral roots in Xunke Oroqen (B. Li, 1996, p. 143)

a. Neutral roots taking non-RTR suffixes

kilimki-wə	‘eyebrow-def.acc’	mitii-wə	‘we; incl.-def.acc’
iŋŋi-wə	‘tongue-def.acc’	ilii-mŋə	‘fish-smelled-aug’
ixiŋki-xəl	‘brush-pl’	diji(n)-təl	‘four each time’
tik-tə	‘to fall-pr.t.’	ʃilgin-nə	‘to tremble-pr.t.’

ir-ʃə	‘to bear fruit-pt.t.’	ii-wkəən-ʃə	‘to enter-caus-pt.t.’
b. Neutral roots taking RTR suffixes			
dili-wa/xal	‘head-def.acc/pl’	igdi-ra/ʃa	‘to comb-pr.t./pt.t.’
ʃirgi-tkaaxi	‘sand-ind.direct’	gilibi-ʃira	‘chilly-diminu.’
kik-ta	‘to bite-pr.t.’	ili-ra	‘to stand-pr.t.’
it-ta	‘to be enough-pr.t.’	ʃimitʃi-wkaan	‘to suck-caus’
ilin-na	‘to blow one’s nose-pr.t.’	ʃilki-ʃ	‘to wash-pt.t.’

Note that the idiosyncratic neutral roots in (95)b correspond to the RTR roots containing /ɪ/ (instead of /i/) in Baiyinna Oroqen.

(96) Cognates in Baiyinna Oroqen (B. Li, 1996, p. 143)

dɪɪ	‘head’	ɪgɪ	‘to comb’
ʃirɪ	‘sand’	gɪɪɪ(-gda)	‘chilly’
kɪk-	‘to bite’	ɪɪ-	‘to stand’
ɪs-	‘to be enough’	ʃimit-	‘to suck’
ɪɪɪn-	‘to blow one’s nose’	ʃilki-	‘to wash’

This indicates that the neutrality of /i/ in Xunke Oroqen is due to the merger of /i/ and /ɪ/ (which is probably a recent development) and that some of the neutral roots still retain the RTR-ness of the original vowels as lexically-marked information (B. Li, 1996).<sup>105</sup>

---

<sup>105</sup> /i/ in Chinese loans behaves consistently as a neutral vowel, taking a non-RTR suffix when it is the only stem vowel (B. Li, 1996, p. 144).



Second, the contrastive status of [labial] is evidenced by labial harmony. As we have seen in many other Tungusic and Mongolic languages, only low rounded vowels trigger labial harmony.

(97) Labial harmony in Xunke Oroqen: high vs. low rounded Vs (drawn from X. Zhang 1996, p. 185ff.)<sup>106</sup>

a. High rounded vowels do not trigger labial harmony, but trigger RTR harmony.

kuwun-mə ‘cotton-DEF.OBJ’          ʊrʊʊn-ma ‘hoof-DEF.OBJ’

b. Low rounded vowels trigger labial and RTR harmony.

tɕɔŋko-wɔ ‘window-DEF.OBJ’          ɔɔ-wɔ ‘fish-DEF.OBJ’

Despite their apparent phonetic roundedness, we lack positive evidence that high rounded vowels have contrastive [labial] specifications due to the fact that they do not trigger labial harmony. The fact that only “low” vowels trigger/undergo labial harmony serves as evidence for contrastive [low].

Xunke Oroqen displays the same “bi-syllabic trigger” condition on labial harmony as Written Manchu (Walker, 2001). Therefore, when linked to only one long vowel, [labial] does not spread (98)d.<sup>107</sup>

<sup>106</sup> Unlike high rounded vowels, low rounded vowels have distributional restriction within a stem.

<sup>107</sup> In Oroqen, there is no such case that [labial] is linked to a single short vowel. Thus, the following vowel sequences are all ill-formed as a stem (X. Zhang 1996, p. 188):

*Co-	*Cɔ-
*CoCi-	*CɔCi-
*CoCu-	*CɔCʊ-
*CoCə-	*CɔCa-

Interestingly, the licensing condition on the stem-internal [labial] is “bi-moraic”, not “bi-syllabic”. Thus, both [Co:]/[Cɔ:] and [CoCo]/[CɔCɔ] are legitimate stems, although the former cannot trigger labial harmony (Walker, 2001, p. 836, fn. 3; see also X. Zhang, 1996 for further detail).

(98) Labial harmony between stem and suffix vowels (X. Zhang 1996, pp. 189-190)

a. [labial] is linked to two short vowels; [labial] spreads

\*(C)oCo-Cə, \*(C)ɔCɔ-Ca

təŋko-wo ‘window-DEF.OBJ’    ɔlə-wə ‘fish-DEF.OBJ’

b. [labial] is linked to a short vowel and a long vowel; [labial] spreads

\*(C)oCoo-Cə, \*(C)ɔCɔɔ-Ca

oloo-ro ‘to boil-PRES’    ɔlgɔɔ-rə ‘to dry-PRES’

c. [labial] is linked to a long vowel and a short vowel; [labial] spreads

\*(C)ooCo-Cə, \*(C)ɔɔCɔ-Ca

mooro-ro ‘to moan-PRES’    mɔɔtəɔn-mə ‘difficulty-DEF.OBJ’

d. [labial] is linked to one long vowel; [labial] does not spread

\*(C)oo-Co, \*(C)ɔɔ-Cɔ

doo-rə ‘to mince-PRES’    mɔɔ-wa ‘tree-DEF.OBJ’

ɔɔ-ra ‘to do-PRES’

As in other Tungusic languages such as Written Manchu and Oroch, all high vowels block labial harmony in Xunke Oroqen.

(99) [labial] spreading is blocked by a high vowel (X. Zhang 1996, p. 190)

a. opaque /i/:

təŋgorin-təərə (\*təŋgorin-təoro) ‘round-Dim’

tərɔki-wa (\*tərɔki-wə) ‘boar-DEF.OBJ’

b. opaque /u, ʊ/:

təŋko-duləək (\*təŋko-dulook) ‘window-ORIGIN’

dʒɔlə-dulaak (\*dʒɔlə-dʊləək) ‘stone-ORIGIN’

According to X. Zhang (1996, p. 179, fn. 21), the “place of origin” marker in (99)b has both long and short forms. Although the long form has only two variants, -*duləək/dulaak*, the short form has four, -*ləək/laak/look/lək*. This suggests that the initial high vowels (/u/ and /ʊ/) in the long form block labial harmony.

Examples like *ɔmɔləε-sal* ‘grandson-PL’ (X. Zhang, 1996, p. 180) show that low front vowels ([εε], [εε]) also block labial harmony. We have seen the same pattern in Oroch. Again, I postulate that the underlying representation of these vowels contain /i/, i.e., /iə, ia/ instead of /ee, εε/. Then, it follows that, due to this underlying /i/ portion with contrastive [-low] specification, they have the blocking effect.

In addition to labial harmony, there is another piece of evidence for [labial]: /oo/ and /ɔɔ/ create a labial glide if they are in a word-initial position (100)a or after a non-labial consonant (100)b.<sup>108</sup>

(100) Labial glide formation by long low rounded vowels /oo, ɔɔ/ (X. Zhang, 1996, p. 163)<sup>109</sup>

a. word-initially			b. after a non-labial consonant		
oorin	[ <sup>w</sup> oorin]	‘all’	doo-	[t <sup>w</sup> oo]	‘mince (meat)’
ɔɔ-	[ <sup>w</sup> ɔɔ]	‘do’	koorgə	[k <sup>hw</sup> oorkə]	‘bridge’
ɔɔkii	[ <sup>w</sup> ɔɔxii]	‘how many’	nɔɔdaa-	[n <sup>w</sup> ɔɔtaa]	‘throw’

<sup>108</sup> There is no labial glide formation after a labial consonant, which can be accounted for by the Obligatory Contour Principle (X. Zhang, 1996, p. 165):

boodo	[pooto]/*[p <sup>w</sup> ooto]	‘kitchen knife’
mooro-	[mooro]/*[m <sup>w</sup> ooro]	‘moan’
poosə	[p <sup>h</sup> oosə]/*[p <sup>hw</sup> oosə]	‘winnowing fan’
mɔɔ	[mɔɔ]/*[m <sup>w</sup> ɔɔ]	‘wood’

<sup>109</sup> There is no labialization by short /o/ or /ɔ/ (X. Zhang, 1996, pp.163-4).

သၣ်ကရ [ʷသၣ်khar] ‘certainly’      တၣ်ကၣ်- [tʰၣ်ကၣ်] ‘span’

Of particular interest is the fact that high rounded vowels do not trigger labialization.

(101) No labialization with high rounded vowels (X. Zhang, 1996, pp. 164–165)

a. no labialization by /u/ or /uu/

uləə-	[uləə]/*[ʷuləə]	‘dig’
nul-	[nul]/*[nʷul]	‘light’
uu-	[uu]/*[ʷuu]	‘puff; blow’
kuumə	[kʰuumə]/*[kʰʷuumə]	‘windpipe’

b. no labialization by /ʊ/ or /ʊʊ/

ʊm-	[ʊm]/*[ʷʊm]	‘drink’
gʊgda	[kʊkta]/*[kʷʊkta]	‘high’
ʊʊn	[ʊʊn]/*[ʷʊʊn]	‘saw’
tʊʊra	[tʰʊʊra]/*[tʰʷʊʊra]	‘read’

Like the labial harmony pattern, this supports the view that the high rounded vowels do not have contrastive [labial] specifications.

Finally, a similar glide formation pattern evidences the contrastive status of [coronal]. At this time, we see palatal glide formation by long low front vowels [ee, eɛ], the underlying representations of which are assumed to be /iə, ia/.

(102) palatal glide formation by long low front vowels [ee, eɛ] (X. Zhang 1996, p. 167ff.)

a. word-initially		b. after a non-velar consonant <sup>110</sup>			
eelu	[ʰeelu]	‘charcoal’	ujəlee	[ujəʰlee]	‘cousin’
ɛɛsa	[ʰɛɛsa]	‘eye’	kooŋdee	[k <sup>h</sup> ooŋd <sup>h</sup> ee]	‘pit’
ɛɛla	[ʰɛɛla]	‘pot of a smoking pipe’	anɛɛ	[an <sup>h</sup> ɛɛ]	‘New Year’
ɛɛɾʊ	[ʰɛɛɾʊ]	‘lair’	bɛɛ	[b <sup>h</sup> ɛɛ]	‘month’

The complementary distribution of the two allophones of alveolar fricative /s/ is also suggestive: /s/ surfaces as the palatalized allophone [ç] when followed by high front vowel /i/ (and its long counterpart /ii/), otherwise [s] (X. Zhang, 1996, p. 171).

(103) Distribution of [s] and [ç] in Xunke Oroqen (X. Zhang, 1996, p. 171)

a. [ç] before /i/	
asi	[açi] ‘now’
sii	[çii] ‘you (sg.)’
sɛɛn=sian	[çɛɛn] ‘ear’
b. [s] before a non-front vowel	
sukə	[suxə] ‘axe’
sunta	[sɔnta] ‘deep’
səkə-	[sɔxɔ] ‘fill’
sarbʊ	[sarbʊ] ‘chopsticks’
sələ	[sələ] ‘iron’

<sup>110</sup> There is no palatalization after a velar consonant (X. Zhang, 1996, p. 169):

əkɛelə-	[əkɛelə]/*[ək <sup>h</sup> ɛelə]	‘tread on’
ɔlɣɛn	[ɔlkɛn]/*[ɔlk <sup>h</sup> ɛn]	‘pig’
kʊŋɣɛ	[k <sup>h</sup> ʊŋkɛ]/*[k <sup>h</sup> ʊŋk <sup>h</sup> ɛ]	‘birch bark bucket’
ŋɛɛlaa	[ŋɛɛlaa]/*[ŋ <sup>h</sup> ɛɛlaa]	‘slope’

c. [s] before a consonant

usikta      [uçik'ta]~[usk'ta]~\*[uçk'ta]      'fingernail'  
asika      [açi'xa]~[as'xa]~\*[aç'xa]      'pinecone'

The examples in (103)c show that unstressed /i/ is optionally deleted and that when this happens /s/ surfaces as [s].

#### 4.2.3.1.2. *Baiyinna Oroqen*

In other Oroqen dialects, we may find a system with the distinction between /i/ and /ɪ/ retained in the inventory. For example, Baiyina Oroqen has the following vowel inventory:

(104) Baiyinna Oroqen vowels (B. Li, 1996, pp. 86–98)

i      u  
ɪ      ʊ  
ie   ə   o  
iɛ   a   ɔ

/ie/ and /iɛ/ are diphthong (B. Li, 1996, p. 91). Thus, I omit them in the following contrastive hierarchy of Baiyinna Oroqen vowels.

(105) Baiyinna Oroqen contrastive hierarchy

a. SDA: [low] > [coronal] > [labial] > [RTR]<sup>111</sup>

---

<sup>111</sup> I maintained the same relative hierarchy between [labial] and [RTR] as in Zhang's Xunke Oroqen hierarchy. However, the reverse hierarchy may be preferable when we consider other Tungusic varieties.

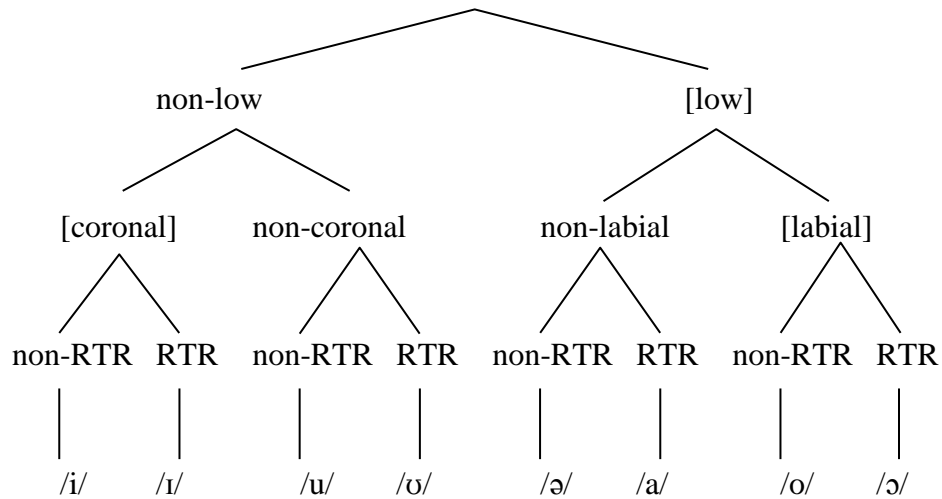

b. Output specification

/i/ = [-low, +cor, -RTR]

/u/ = [-low, -cor, -RTR]

/ɪ/ = [-low, +cor, +RTR]

/ʊ/ = [-low, -cor, +RTR]

/ə/ = [+low, -lab, -RTR]    /o/ = [+low, +lab, -RTR]

/a/ = [+low, -lab, +RTR]    /ɔ/ = [+low, +lab, +RTR]

The phonological patterns are similar to those in Xunke Oroqen.

(106) RTR and labial harmony in Baiyinna Oroqen

a. Derivational suffix: -xi / -xɪ

nəlki	‘spring’	nəlki-xi	‘to spend spring’
tuwə	‘winter’	tuwəxi	‘to spend winter’
dʒɔwa	‘summer’	dʒɔwa-xɪ	‘to spend summer’
dɔlbɔ	‘night’	dɔlbɔ-xɪ	‘to spend night’

b. Derivational suffix: -ruk / -rɔk

imuksə	‘oil’	imuksə-ruk	‘oil container’
uktu	‘gun powder’	uktu-ruk	‘gun powder container’
amɔn	‘shit’	amɔ(n)-rɔk	‘toilet’

c. Derivational suffix: -mə / -ma / -mo / -mɔ

əwi	‘to play’	əwi-mə	‘who likes to play’
um	‘to drink’	um-ma	‘who likes to drink’
oloo	‘to cook’	oloo-mo	‘who likes to cook’
ɔŋɔ	‘to weep’	ɔŋɔ-mɔ	‘who likes to weep’

The data in (106)c show that only low vowel suffixes are subject to the labial harmony. The restrictions imposed on the long low rounded vowels /oo/ and /ɔɔ/ with respect to labial harmony in Xunke Oroqen (98) seem to work the same way in Baiyinna Oroqen: they cannot trigger labial harmony for themselves, but they participate in and propagate labial harmony when preceded by another instance of short vowel /o/ or /ɔ/ (B. Li, 1996, pp. 130–131).

As in Xunke Oroqen and all other Tungusic languages with labial harmony, all high vowels in Baiyinna Oroqen block the labial harmony. The blocking effect of /ie/ and /iɛ/ is ascribed to /i/ and /ɪ/.

(107) Blocking of labial harmony in Baiyinna Oroqen (B. Li, 1996, p. 132).

a. Non-RTR words

moliktə	‘a kind of wild fruit’
bolboxi-wə	‘wild duck-def.acc’
bombonkie-wə	‘Shaman’s hat-def.acc’
owon-duləə	‘pancake-destin’

b. RTR words

ɔxixan	‘flame’
ʃɔlik-pa	‘cloud-shaped design-def.acc’
ɔmɔliɛ-xal	‘grandson-pl’



ɔɾɔn-dɔlaa 'reindeer-destin'

#### 4.2.3.2. Ewenki

According to published descriptions, Literary Ewenki has a reduced vowel system as follows:

(108) Literary Ewenki vowels (B. Li, 1996, p. 149, based on Konstantinova 1964)<sup>112</sup>

i	i:		u	u:	'neutral'
		ə	ə:		'soft'
ɛ:	a	a:	ɔ	ɔ:	'hard'

However, others have recognized in Ewenki dialects that there are “soft” and “hard” variants for /i, u/: e.g., Vasilevich (1940, 1948, 1958) and Romanova & Myreeva (1962, 1964), as cited in de Boer (1996).

(109) Ewenki vowels (de Boer, 1996, based on Vasilevich, 1958)

	front		central		back	
high	i	i:	ɨ	ɨ:	ɯ	ɯ:
mid		e:	ə	ə:	o	o:
low					a	a:

Yang's (2010) acoustic study of an Eastern dialect confirms that there are harmonic variants for /i, u/, although they are viewed as /ɨ, ɯ/ based on their acoustic properties

<sup>112</sup> Bulatova & Grenoble (1999) list [ɨ ɨ: ɛ ɛ: ɔ] as positional variants. Also, they treat /a, a:/ as front vowels, as in Konstantinova (1964).

such as F1 (vowel height) difference. Ewenki dialects spoken in China seem to further distinguish /o/ and /ɔ/ as described in all the references cited in X. Zhang (1996, pp. 197-8). Thus, it may be viewed that the vowel system of Literary Ewenki in (108) is not a reflection of any actual spoken dialects but an abstract system based on an “artificial” language (de Boer, 1996, p. 124).

Ewenki has the same vowel patterns as Oroqen.

(110) Vowel harmony in Ewenki (Z. Hu & Chaoke, 1986, as cited in X. Zhang, 1996, p. 199)

a. labial harmony

Non-RTR		RTR	
oloo-ro	‘boil-pres.tense’	ʃɔxɔ-rɔ	‘scoop up-pres’
xobo-ro	‘liberate-pres’	ʃɔŋɔ-rɔ	‘cry-pres’

b. no labial harmony

Non-RTR		RTR	
toʃfo-ni	‘cloud-possessive’	bɔŋgɔ-ʃɪla	‘big-diminutive’
oloxuʃi-rə	‘cheat-pres’	xɔxɔʃi-ra	‘shout-pres’

c. no labial harmony

Non-RTR		RTR	
oodən	‘down (n.)’	ɔɔ-ra	‘do-pres’

Ewenki has both RTR and labial harmony. Only low rounded vowels trigger labial harmony. (a) illustrates the bi-syllabic trigger condition: Labial harmony applies when the two consecutive syllables contain the same low rounded vowels. (b) illustrates the blocking of labial harmony by high vowels. (c) a long rounded vowel fails to trigger labial harmony. All these are what we have seen in Oroqen.

Therefore, I assume that Ewenki has the same contrastive hierarchy as Oroqen.

#### 4.2.3.3. Solon

Solon has the following vowel inventory:<sup>113</sup>

(111) Solon vowels (Z. Hu & Chaoke, 1986; as cited in B. Li, 1996, p. 103)

i	ii			u	uu
ɪ	ɪɪ			ʊ	ʊʊ
	ee	ə	əə	o	oo
	ɛɛ	a	aa	ɔ	ɔɔ

Svantesson's (1985) acoustic analysis (formant frequency) confirms the above system, although his analysis is done with only one Solon speaker.

According to B. Li (1996), the Solon vowel harmony system “shares most of the major formal properties we have observed in Baiyinna Orochen” (B. Li, 1996, p. 145). The only difference may be that, unlike in Oroqen (cf. (98)), there is no prosodic restriction on the trigger vowels of labial harmony: [labial] linked to a long vowel, /oo/ or /ɔɔ/, also trigger labial harmony in Solon.

(112) Labial harmony triggered by /oo/ and /ɔɔ/ in Solon (B. Li, 1996, p. 145)

---

<sup>113</sup> Tsumagari proposed a slightly different system for Solon:

Solon vowels (Tsumagari, 2009b, p. 3)						
close	ə	o	u			
				neutral	i	ɛ
open	a	ɔ	ʊ			

According to Tsumagari, the Solon vowel harmony is not strict: close vowels sometimes appear after open vowels (Tsumagari, 2009b, p. 3)

a. Non-RTR words

ooto	‘lungs’	xooson	‘foam’
xoomo-wo	‘meal-def.acc’	xooggo-do-ro	‘to build a bridge’

b. RTR words

төөл	‘rabbit’	бээгэ	‘yoke’
гүүл	‘copper’	түүлэн	‘five-year-old bull’
дун-лун	‘inside-locat’	ун-гун	‘to do-im. imper. 1 <sup>st</sup> . sg.’
мун-вун	‘tree-def.acc’	бүүлүн-вун	‘hail-def.acc’

I assume that Solon has the same contrastive hierarchy as Oroqen and Ewenki.

#### 4.2.3.4. Ewen (Lamut)

Ewen has a similar system with Oroqen:

(113) Ewen (J. Kim, 1989; B. Li, 1996; all based on Novikova, 1960)

i	u
ɪ	ʊ
ie	ə o
æ	a ɔ

The above vowel system is based on Novikova’s description on Ola dialect.

Beryozovka dialect has the same vowel system (J. Kim, 2011). Lebedev (1982), as cited in Kaun (1995), describes similar but slightly different vowel system in Oxots Ewen. The differences are as follows: in Oxots Ewen /ie/ (described as a diphthong) is neutral to vowel harmony; there is no /æ /; /ə/ surfaces as [ɛ] (cf. Khalkha [e]).

The vowels /ie/ and /æ/ are of secondary origin and phonetically slightly diphthongised and longer than other short vowels in Ola dialect (B. Li, 1996, p. 101, based on Novikova, 1960). Neutral /ie/ in Oxots Ewen is also described as a diphthong (Lebedev, 1982, as cited in Kaun, 1995, pp. 78-9).

The phonological patterns in Ewen are as follows. First, both /i/ and /ɪ/ (as well as /ie/ and /æ/) may palatalize the preceding consonant (B. Li, 1996, pp. 100-101).

(114) Palatalization (J. Kim, 2011, p. 27): when followed by /i/, /ɪ/, or /j/,

a. /k/ surfaces as [c]

/kimdaj/	[cimdaj]	‘cook’	/həwki/	[həwci]	‘god’
/torkɪ/	[tɔrcɪ]	‘sledge’	/hjākɪta/	[çɑ:cɪta]	‘tree’

b. /g/ surfaces as [ɟ]

/gǰā/	[ɟa:]	‘friend’	/gɪd/	[ɟɪd]	‘spear’
/gǰākan/	[ɟaqaŋ]	‘hawk’	/bɔlgɪt/	[bɔɟɪt]	‘pine tree’

c. /h/ surfaces as [ç]

/hiləs/	[çiləs]	‘dew’	/hīsəçin/	[çi:səçin]	‘evening’
/hırkan/	[çırqaŋ]	‘knife’	/hjōt/	[çə:t]	‘thread’
/hil/	[çil]	‘soup’	/hjākɪta/	[çɑ:cɪta]	‘tree’

Second, Ewen displays a rigorous vowel harmony for which I assume an RTR harmony following J. Kim (1989, 2011) and B. Li (1996).<sup>114</sup>

(115) Suffixal vowel harmony (data drawn from J. Kim, 2011)

---

<sup>114</sup> See Aralova et al. (2011) and Kang & Ko (2012) for the phonetics of Ewen vowels.

a.	hor-li	‘go-IMP_2SG’	hılkat-lı	‘rinse-IMP_2SG’
	(2 <sup>nd</sup> person imperative)			
b.	min-du	‘I-DAT’	moran-du	‘horse-DAT’
	tugǎni-du	‘winter-DAT’	ğuganı-du	‘summer-DAT’
c.	toğar-duk	‘lake-ABL’	bazar-duk	‘market-ABL’
	kubət-tuk	‘all-ABL’	ısag-duk	‘forest-ABL’
d.	ǎni-nun	‘mother-COM’	arıç-ñun	‘good-COM’
e.	hupkučäk-lə	‘school-LOC’	ğö-la	‘house-LOC’
	biläk-lə	‘village-LOC’	dälbañı-la	‘night-LOC’
f.	nöñil-täki	‘younger sister-DIR’	akan-takı	‘brother-DIR’

From the above examples, we identify the following two sets of vowels:

(116) Harmonic sets in Ewen (J. Kim, 2011; Kaun, 1995, p 80)

- a. Set A (non-RTR vowels):    i   ə   u   o
- b. Set B (RTR vowels):        ı   a   ö   ɔ

These vowel sets condition the velar-uvular alternation of dorsal consonants:

(117) Velar ~ uvular alternation (J. Kim, 2011)

- a. /k/: [k] ~ [q]
 

/bokəs/	[bokəs]	‘ice’	/ᵛsıkat/	[ɔ:sıqat]	‘star’
/küntäk/	[ku:ntäk]	‘field’	/kuŋa/	[quŋa]	‘child’
/kökən/	[ko:kən]	‘daughter-in-law’	/körbaka/	[qörbaqa]	‘hat’
- b. /g/: [g] ~ [ɣ] (in syllable-initial positions)
 

/gərbə/	[gərbə]	‘name’	/bılga/	[bılɣa]	‘throat’
---------	---------	--------	---------	---------	----------

/gurgə/	[gurgə]	‘work’	/gɔrgat/	[gɔrgat]	‘beard’
			/gɔssi/	[gɔssi]	‘bitter’

c. /g/: [ɣ] ~ [ʁ] (in intervocalic or syllable-final positions)

/həgtə/	[həɣtə]	‘branch’	/hagdi/	[haxdi]	‘adult’
/həgəp/	[həɣəp]	‘sable’	/ʃɔgaŋi/	[dʒɔʁaŋi]	‘summer’
/iŋ/	[i:ɣ]	‘sound’	/bjāg/	[bjɑ:ʁ]	‘moon; month’
/digən/	[diɣən]	‘four’	/čɔg/	[ʃɔʁ]	‘bell’

A distinctive characteristic of Ewen is that, unlike other Tungusic languages, it displays no labial attraction/harmony.

(118) Cognates of ‘autumn’ and ‘night’ in Tungusic<sup>115</sup>

	‘autumn’	‘night’	Reference
Ewen	bɔlaŋɪ	dɔlba	(J. Kim, 2011; Robbek & Robbek, 2005)
Ewenki	bolo	dolbo	(Cincius, 1975)
Solon	bolo	dolbo	(Cincius, 1975)
Oroqen	bɔlɔ	dɔlbo	(B. Li, 1996, p. 127)
Negidal	bolo	dolbo	(Cincius, 1975, 1982)
Manchu	bolori	dobori	(Cincius, 1975)
Udihe	bolo	dogbo	(Cincius, 1975; Nikolaeva & Tolskaya, 2001)
Oroch	bolo	dobbo	(Cincius, 1975)
Ulchi	bolo	dolbo	(Cincius, 1975)
Uilta	bolo	dolbo	(Cincius, 1975)

<sup>115</sup> The symbol “o” in the examples is retained as used in the original references since we are focusing on the roundedness of vowels, not the phonetic quality in general.

We have seen that Nanai has no labial harmony, either. However, as can be seen in the examples *bolo* ‘autumn’ and *dolbo* ‘night,’ Nanai shows stem-internal labial attraction. In the Nanai section (§4.2.2.5), we have also seen that there is a trace of labial harmony at an earlier stage in Nanai.

Initial /o/ is not stable in some variety of Ewen. For example, in Oxots Ewen, a majority of words containing /o/ show a free variation with an alternate pronunciation with /u/. (Kaun, 1995, p. 82)

(119) Free variation between /o/ and /u/ in Oxots Ewen (Kaun, 1995, p. 83)

oʏɛr ~ uʏɛr <sup>116</sup>	‘top (adj.)’	okɛɛ ~ ukɛɛ	‘suckling’
oyin ~ uyin	‘above’	ostɛy ~ ustɛy	‘to pull strongly’
o:ɣɛy ~ u:ɣɛy	‘recently’	o:r ~ u:r	‘sleeve’
o:si ~ u:si	‘doorman’	bokun ~ bukun	‘icing up/over’
doktɛ ~ dukɛ	‘alder’	morun ~ murun	‘footwear’
noki ~ nuki	‘arrow’	bo:rɣɛn ~ bu:rɣɛn	‘return (n.)’
go:n ~ gu:n	‘utterance’	do:yurɛn ~ du:yurɛn	‘removing’
mo: ~ mu:	‘water’		

By contrast, /ɔ/ does not alternate with /u/. Instead, optional labial harmony is observed in many words with initial /ɔ/ (p. 83). This may indicate the relative weakness of [labial] contrast.

---

<sup>116</sup> This must be a typo of *uʏɛr*.



(120) Optional labial harmony found in certain words with initial /ɔ/ in Oxots Ewen  
(Kaun, 1995, p. 83)

bɔlanɪ ~ bɔlɔnɪ	‘in the midst of autumn’
bɔlanɪvay ~ bɔlɔnɪvay	‘for autumn to set in’
dɔlbani ~ dɔlbɔnɪ	‘night’
ɔlla ~ ɔllɔ	‘fish’
ɔrandan ~ ɔrɔndan	‘deer ride’
ɔrapčɪ ~ ɔrɔpčɪ	‘rich with deer’
ɔrar ~ ɔrɔr	‘deer’
ɔyalta ~ ɔyɔltɔ	‘small column’

According to Malchukov (1995, p. 123), this optional labial harmony can be viewed as the influence of Yakut (a Turkic language) vowel harmony: “some Tungusic varieties within the contact zone have developed labial harmony resulting in “*o*-pronunciation” (Russian *okanie*) of reduced vowels in non-initial syllables, e.g., Eastern Even *oron* < *orun* ‘reindeer’, *n’ööltön* < *n’öölten* ‘sun’.”

As B. Li (1996, p. 147) points out, if we accept that Ewen is the most conservative Tungusic language, Tungusic labial harmony can be viewed as a later innovation. This is interesting since we saw that labial harmony is a later development in the Mongolic languages: unlike modern Mongolic varieties (e.g., Khalkha), Old Mongolian had no labial harmony.

Although there is no clear evidence for [labial], I propose the following contrastive hierarchy for Ewen vowels which incorporates [labial] as the lowest-ranked contrastive feature.

(121) Contrastive hierarchy for Ewen

a. SDA: [low] > [coronal] > [RTR] > [labial]

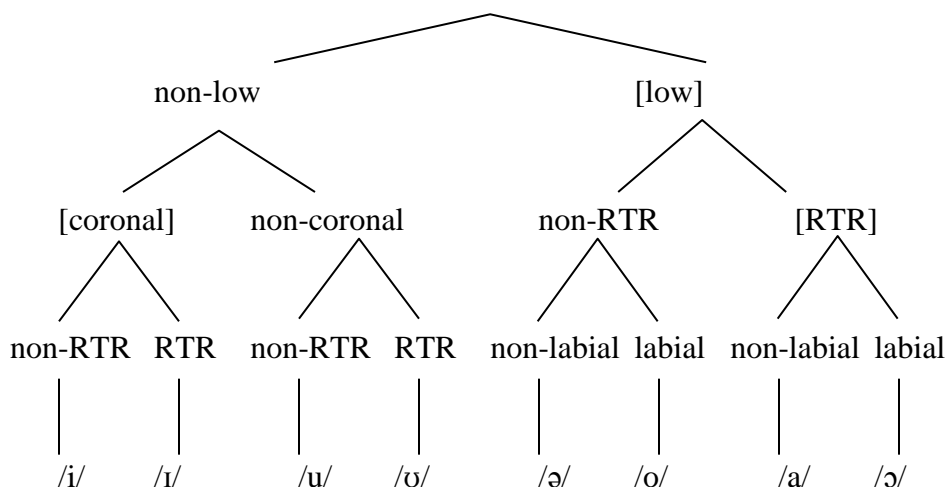

b. Output specification

/i/ = [-low, +cor, -RTR]

/u/ = [-low, -cor, -RTR]

/ɪ/ = [-low, +cor, +RTR]

/ʊ/ = [-low, -cor, +RTR]

/ə/ = [+low, -RTR, -lab]    /o/ = [+low, -RTR, +lab]

/a/ = [+low, +RTR, -lab]    /ɔ/ = [+low, +RTR, +lab]

#### 4.2.3.5. Negidal

According to Kazama (2003), Negidal has the following vowel inventory,<sup>117</sup> which is similar to other Northern Tungusic varieties:

(122) Negidal vowel inventory (Kazama, 2003, p. 12)

i	u
ɪ	ʊ
ə	o

<sup>117</sup> Symbols were changed accordingly.

a ɔ

cf. /e/ and /ee/

I am unaware of any published description on the phonological patterns of Negidal. Thus, no phonological patterns are presented here. However, even purely based on the above vowel inventory, it seems highly likely that Negidal has the same contrastive hierarchy as other Tungusic languages, especially those with a 8-vowel system such as Ewen, Oroqen, and Uilta.

### 4.3. Historical development of Tungusic vowel systems

The contrastive hierarchy for Tungusic languages is almost invariantly [low] > [coronal] > [RTR] > [labial]. Nanai, which was analyzed as having lost the contrastive [labial], also retains the basic ordering among the remaining three contrastive features. Then, with the null hypothesis is that Proto-Tungusic had the same contrastive hierarchy as modern Tungusic, we may assume that Proto-Tungusic had the same vowel system as a canonical Tungusic language , e.g., Ewen , unless evidence shows otherwise.

(123) Proto-Tungusic vowel system: an RTR analysis (Joseph & Whitman, 2012)

*i	*u
*ɪ	*ʊ
*ə	*o
*a	*ɔ

Overall, this view is consistent with the historical sketch of Tungusic vowel changes given in B. Li (1996).

(124) Tungusic vowel changes (B. Li, 1996, p. 119)

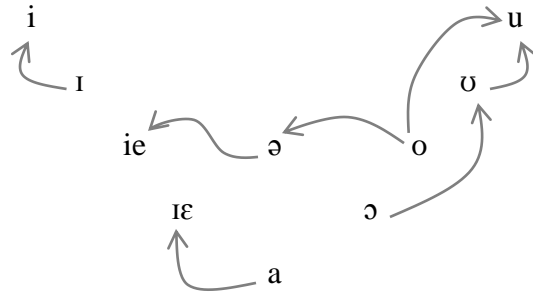

However, the conventional view has been that the Proto-Tungusic vowel system was based on a palatal contrast (Cincius, 1949; Benzing, 1956).

(125) Proto-Tungusic vowel system: a palatal analysis (Benzing, 1956), as cited in Joseph & Whitman (2012)

“hellen [bright]”	“dumpfen [dim]”
*i	*i
*ü	*u
*ö	*o
*ä	*a

As we have seen in Mongolic and Korean cases, this traditional palatal analysis may be incorrect. Rather, as Joseph & Whitman (2012) point out, the following basic vowel correspondences in modern Tungusic languages favor the RTR-based reconstruction over the conventional reconstruction of the Proto-Tungusic vowels.

(126) Basic vowel correspondences (Joseph & Whitman, 2012)

<b>Benzing</b>	<b>*i</b>	<b>*ĩ</b>	<b>*ü</b>	<b>*u</b>	<b>*ä</b>	<b>*a</b>	<b>*ö</b>	<b>*o</b>
Ewen	i	ɪ	i/u	ɪ/ʊ	ə	a	u/o	ɔ
Oroqen	i	ɪ	i/u	ɪ/ʊ	ə	a	u/o	ɔ
Oroch	i	i	i/u	u	ə	a	u	ɔ
Udihe	i	i	i/u	u	ə	a	u	ɔ <sup>118</sup>
Orok	i	ɪ	u	ʊ	ə	a	u/o	ɔ
Nanai	i	ɪ	u	ʊ	ə	a	u	ʊ
Manchu	i	i	u	u/ʊ	ə	a	u/ə	ɔ
<b>TR</b>	<b>*i</b>	<b>*ɪ</b>	<b>*u</b>	<b>*ʊ</b>	<b>*ə</b>	<b>*a</b>	<b>*o</b>	<b>*ɔ</b>

---

<sup>118</sup> This vowel in Udihe was treated as /o/ in my analysis. See §4.2.2.2.

CHAPTER FIVE  
TUNGUSIC VS. MONGOLIC LABIAL HARMONY

**5.1. Introduction**

As observed by van der Hulst and Smith (1988), there is a minimal phonological difference between Tungusic and Mongolic languages with respect to labial harmony: Tungusic /i/ is opaque, whereas Mongolic /i/ is transparent to labial harmony. This is illustrated in (1) with “Standard (or Literary)” Ewenki (Tungusic) and Khalkha/Buriat (Mongolic) examples.

- (1) a. Standard Ewenki
- |       |                    |                    |
|-------|--------------------|--------------------|
| ɔɔɔr- | ɔɔɔr-ɔ (*-a)       | ‘deer-ABLATIVE’    |
|       | ɔɔɔr-igla (*-igla) | ‘deer-DESTINATIVE’ |
- b. Khalkha/Buriat
- |        |                   |                  |
|--------|-------------------|------------------|
| mɔrin- | mɔrin-ɔɔs (*-aas) | ‘horse-ABLATIVE’ |
|--------|-------------------|------------------|

This minimal difference is indeed a difference between the entire language groups, not a difference just between the above two particular languages. Exactly the same pattern is found extensively in each group of languages. In all Tungusic languages known to have a productive labial harmony process,<sup>1</sup> all high vowels (/i, u, ʊ/) are opaque to the labial harmony: e.g., Standard(Literary) Ewenki (B. Li, 1996; van der Hulst & Smith, 1988), Oroqen (B. Li, 1996; X. Zhang, 1996), Solon (B. Li, 1996), Written(Classical) Manchu (B. Li, 1996; X. Zhang, 1996), Oroch (Avrorin & Boldyrev, 2001; Avrorin &

---

<sup>1</sup> Not included here are Ewen and Nanai which do not have labial harmony.

Lebedeva, 1978; Comrie, 1981; Kaun, 1995; Tolskaya, 2008), Ulch (Kaun, 1995; Sunik, 1985), Udihe (Nikolaeva & Tolskaya, 2001, p. 72). Labial harmony in these languages are confined to low vowels. However, even in Spoken Manchu and Sibe where all rounded vowels including high rounded vowels trigger labial harmony, /u/ and /y/ behave as opaque in the sense that they block the spreading of harmonic features and create their own harmonic span (B. Li, 1996). By contrast, in Mongolic languages with labial harmony, /i/ (and /ɪ/) is transparent while /u/ (and /ʊ/) is opaque: e.g., Mongolian Proper such as Khalkha and Chakhar, and Buriat. Thus, a desirable analysis must be able to capture the difference as a formal one between the two language groups.

The proposal in this chapter is that the minimal contrast between Tungusic and Mongolic languages can be captured in terms of the minimal difference in the contrastive hierarchy (Dresher, 2009). When we compare a canonical Tungusic language (Oroqen) and a canonical Mongolic language (Khalkha), we find that Tungusic assigns the hierarchy [low] > [coronal] > [labial] > [RTR] (X. Zhang, 1996) whereas Mongolic [coronal] > [low] > [labial] > [RTR]. Then the minimal difference is reduced as the difference of relative hierarchy between [low] and [coronal]. Under these minimally different hierarchies, Tungusic and Mongolic /i/ receive different feature specifications, which explains their different behaviors.

The organization of this chapter is as follows: Section 5.2 introduces the pioneering work by van der Hulst and Smith (1988) and addresses the difficulties it cannot resolve. Section 5.3 introduces the framework adopted here: Fusional Harmony (Mester, 1986). Section 5.4 presents the contrastive hierarchy analysis of Oroqen and Khalkha as a simple but an elegant solution to the labial harmony patterns in these languages. Section 5.5 compares my proposal with alternatives. Section 5.6 concludes the chapter.





To capture the minimal difference between the two languages, van der Hulst & Smith (1988) relies on the presence and absence of a governing specification for [I] in Tungusic /i/ and Mongolic /i/ respectively. What is to be noted here is the different phonetic qualities of the ATR<sup>3</sup> counterpart to /a/, i.e., /ə/ in Ewenki and /e/ in Khalkha. Unlike Ewenki /ə/, Khalkha /e/ is realized as a front vowel. Thus it differs from /a/ with respect not only to dependent feature [I] (ATR) but also to governing feature [I] (palatal constriction). Since Khalkha /e/ is the [+ATR] counterpart to /a/ (= |A|), its underlying representation must be |A<sup>i</sup>| and the feature [I] is introduced by a redundancy rule which derives governing [I] from dependent [I]. A consequence is that, since a [I]-introducing redundancy rule is already available, /i/ can also be represented simply as |.<sup>i</sup>|, not |I<sup>i</sup>|, underlyingly. Then, as illustrated below, the empty node of Khalkha /i/ does not count as a barrier to the ‘fusional harmony’ (Mester, 1986).

(3) Transparency: Khalkha /i/ (van der Hulst & Smith, 1988, p. 84)

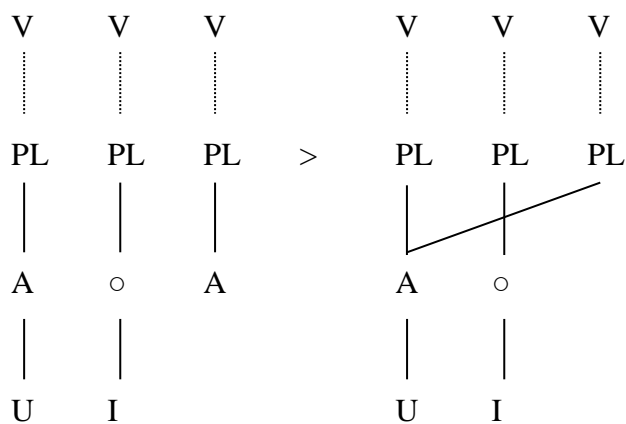

<sup>3</sup> I will follow their ATR-based analysis, since the choice between [ATR] and [RTR] is not crucial here.

On the contrary, /i/ in Ewenki and /u, ʊ/ in both languages are all opaque to labial harmony, as they have either [I] or [U] as a governing feature which obstructs the fusion of another governing feature [A].

(4) Opacity (van der Hulst & Smith, 1988, p. 84f.)

a. Ewenki /i/

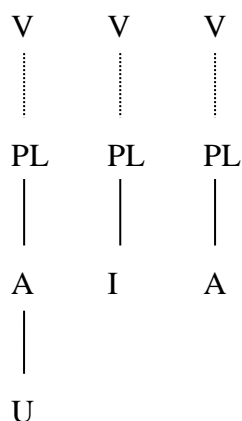

b. Ewenki/Khalkha /u, ʊ/

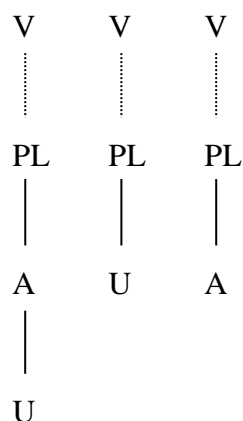

However, this analysis faces several problems. First, it offers a bipartite analysis on the blocking effect of the opaque vowels, assuming two different blocking features: [I] for /i/ and [U] for /u, ʊ/. Second, these proposed blocking features seem to lack phonetic and typological plausibility. To my best knowledge, there are no known phonetic principles as to why frontness or roundness would block the spreading of roundness. Rather, as Kaun (2004) concludes from a typological survey of over thirty-three languages, height plays a crucial role in labial harmony as summarized below:

(5) The effects of height on labial harmony (Kaun, 2004, p. 88)

- a. The trigger must be nonhigh.
- b. The target must be high.
- c. The trigger and target must agree in height.

Of particular interest is the third principle in (5)c, since it has recently been regarded as the cause of the blocking effect in labial harmony by Kaun (1995) and Nevins (2010). This principle is phonetically grounded: cross-height harmony is avoided because the magnitude of lip rounding gesture is not equivalent for high and nonhigh rounded vowels. That is, nonhigh rounded vowels involve less lip rounding and/or less lip protrusion than high rounded vowels (Kaun, 2004, p. 98ff.).

Third, in van der Hulst and Smith's analysis, the palatalizing effect of Mongolic /i/ evidenced by palatalized consonants and vowel umlaut does not receive a proper treatment. In their analysis, the palatalizing feature [I] of /i/ is not specified underlyingly but introduced later by a redundancy rule. Therefore, to explain the palatalizing effect, we must assume that a redundant value operates in phonology proper. This is, however, undesirable under the Contrastivist Hypothesis.

Finally, but more than anything else, the analysis cannot be applied to other Mongolian varieties such as Shuluun Höh Chakhar, a Southern Mongolian, with a richer inventory but the same harmony patterns.

(6) Chakhar vowel inventory (Svantesson et al., 2005, p. 144)

i	y	u
ɪ	ʏ	ʊ
e	ø	ɘ
ɛ	æ	ɔ

Unlike Khalkha but rather like Ewenki, Chakhar has /ɘ/ instead of /e/ as the ATR counterpart to /a/. This means that there is no redundancy rule which would later introduce governing feature [I] to /i/. Without this redundancy rule, the underlying

representation of /i/ must bear the specification for [I]. Then, the prediction is that /i/ (as well as its non-ATR counterpart /ɪ/) would be opaque, not transparent, to labial harmony. However, this prediction is not borne out: Chakhar /i/ is just as transparent as Khalkha /i/.

### 5.3. Framework: Fusional Harmony (Mester, 1986)

The present analysis is based on *contrastive hierarchy* (Dresher, 2009) as a theory of feature specification and *fusional harmony* (Mester, 1986) as a model of vowel harmony. For the theory of contrastive hierarchy, see §1.3.2. Here, I will only briefly introduce the theory of fusional harmony.

Fusional harmony (Mester, 1986) is proposed as a model of “height-stratified” labial harmony found in, e.g., Yawelmani Yokuts, whereby labial harmony applies only when the trigger and the target share the same height as shown below:<sup>4</sup>

(7) Yawelmani Yokuts (Mester, 1986)

a. vowel inventory

i	u
o	
a	

b. vowel harmony

- |   |   |
|---|---|
| i. /u/ rounds a following /i/           | u C <sub>0</sub> i → u C <sub>0</sub> u |
| ii. /o/ rounds a following /a/          | o C <sub>0</sub> a → o C <sub>0</sub> o |
| iii. /u/ does not round a following /a/ | u C <sub>0</sub> a ↗ u C <sub>0</sub> o |
| iv. /o/ does not round a following /i/  | o C <sub>0</sub> i ↗ o C <sub>0</sub> u |

---

<sup>4</sup> See also Archangeli (1984).

Mester assumes that the [round] tier is dependent on the [high] tier as follows:

(8) [round] is dependent on [high] (Mester, 1986)

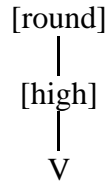

In this model, the effect of [round] spreading is achieved by the fusion of the [high] tier. If the trigger and the target vowels share the same height, fusional harmony applies. If the vowels have a different height, then fusional harmony fails to apply and a default value for [round] is assigned.

(9) Fusional harmony in Yawelmani Yokuts (Mester, 1986)

a. Same height: harmony applies.

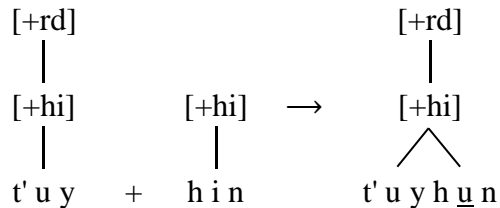

b. Different height: harmony fails and a default value is assigned.

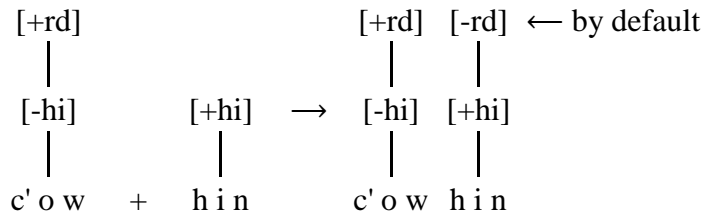

## 5.4. Analysis

In this section, I present a contrastive hierarchy analysis of Oroqen (a Tungusic) and Khalkha (a Mongolic). Oroqen is selected in place of Literary Ewenki, because the Literary Ewenki vowel inventory is quite controversial (de Boer, 1996). In contrast, the Oroqen vowel inventory has been well established and previously analyzed within the framework of contrastive hierarchy (X. Zhang, 1996). Furthermore, it is almost the same as the Khalkha vowel inventory, which makes the comparison much more effective:

### (10) Vowel inventory

#### a. Oroqen

i      u  
           ʊ  
       ə    o  
       a    ɔ

#### b. Khalkha

i      u  
           ʊ  
       e    o  
       a    ɔ

The contrastive hierarchies of Oroqen and Khalkha are given in (11) and (12) below, each of which was discussed in depth in §4.2.3.1 and §2.2.1.1, respectively.

### (11) Contrastive hierarchy for Oroqen (X. Zhang, 1996)

#### a. SDA: [low] > [coronal] > [labial] > [RTR]

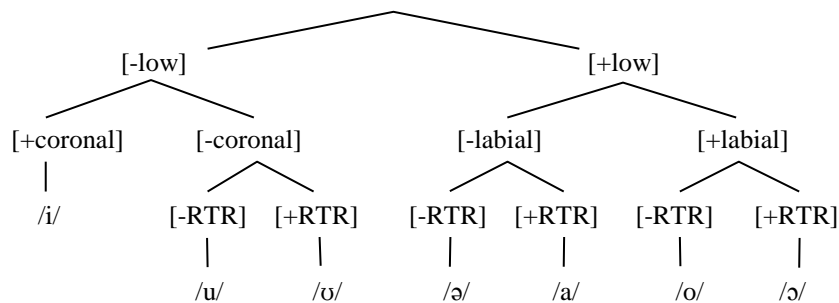



The evidence for the contrastive status of the proposed features [coronal], [RTR], [labial], and [low] can be summarized as follows:

(13) Summary of evidence for the contrastive status of features

- a. [coronal] consonant palatalization, vowel umlaut  
Oroqen [j]-formation
- b. [RTR] RTR harmony
- c. [labial] labial harmony, Oroqen [w]-formation
- d. [low] height restriction on the trigger/target of labial harmony  
trigger restriction in Oroqen [w]-formation

First, the contrastive status of [coronal] is evidenced by palatalization in both languages. In Oroqen, /i/ palatalizes preceding /s/, resulting in [ɕ]. In Khalkha, consonant palatalization is more pervasive. These are illustrated in (14) below.

(14) Evidence for [coronal]

- a. Oroqen: palatalization of /s/ by /i/ (X. Zhang, 1996, p. 171)
  - i. [s] before a non-front vowel                      ii. [ɕ] before a front vowel
  - sukə            [suxə]            ‘axe’                      asi            [aɕi]            ‘now’
  - səkə-            [səxə]            ‘fill’
  - sarbʊ            [sarbʊ]            ‘chopsticks’
- b. Khalkha: palatalized consonants (Svantesson et al., 2005, p. 26ff.)
  - i. non-palatalized Cs                                      ii. palatalized Cs
  - p<sup>h</sup>aɣ            ‘splash!’                                      p<sup>h</sup>aɣ<sup>i</sup>            ‘plate’
  - aɣ            ‘tight’    aɣ<sup>i</sup>            ‘wormwood’
  - cam            ‘road’    čam            ‘law’





d. low rounded Vs: labial harmony

təŋko-wo	‘window-DEF.OBJ’	ot-oor	‘feathers-INST’
ɔlo-wə	‘fish-DEF.OBJ’	ɔt-ɔɔr	‘star-INST’

/i/ is transparent to RTR harmony in both languages, which indicates that /i/, albeit phonetically advanced, lacks specification for [ $\pm$ RTR].

(16) /i/ is transparent to RTR harmony

a. Oroqen (X. Zhang, 1996)

nəkin-nə	‘sweat-PAST’	tari-wa	‘that-DEF.OBJ’
ulin-mə	‘betrothal gift-DEF.OBJ’	mɔrin-ma	‘horse-DEF.OBJ’

b. Khalkha (Svantesson et al., 2005)

te:ɣ-ig-e:	‘gown-ACC-REFL’	ç <sup>h</sup> a:s-ig-a:	‘paper-ACC-REFL’
su:ɣ-ig-e:	‘tail-ACC-REFL’	mɔ:r-ig-a:	‘cat-ACC-REFL’

With these four contrastive features, we have twenty four logically possible feature orderings. Recall, however, that a legitimate ordering must satisfy all the following desiderata given in (17).<sup>6</sup>

(17) Desiderata for desired outcome for both Oroqen and Khalkha

- a. D1: /i/ must bear [+coronal] specification.
- b. D2: /i/ must lack specification for [ $\pm$ RTR].

---

<sup>6</sup> The particular way of demonstration in (17) and (18) is borrowed from Nevins (2010, pp. 114–5), although he uses it to show that any possible ordering fails to assign the right specifications for Oroch, a Tungusic language. In §4.2.2.1, I demonstrated that Oroch vowel harmony can be explained under the contrastive hierarchy [low] > [coronal] > [RTR] > [labial], coupled with the current assumption that only height difference is relevant to the blocking effect of high vowels to labial harmony.

- c. D3: /u, ʊ/ must lack specification for [±labial].
- d. D4: /e(ə), a, o, ɔ/ must form a natural class<sup>7</sup> (excluding /i, u, ʊ/) with respect to labial specification.

(18) shows a step-by-step procedure whereby SDA is being applied to all logically possible orderings.

(18) Applying SDA to Oroqen and Khalkha

- a. If [±RTR] first: fails, since it assigns [-RTR] to /i/, contra D2.
- b. If [±lab] first: fails, since it assigns [+lab] to /u, ʊ/, contra D3.
- c. If [±low] first: assigns [+low] to /e(ə), a, o, ɔ/ and [-low] to /i, u, ʊ/.
  - i. If [±RTR] second: fails, since it assigns [-RTR] to /i/, contra D2.
  - ii. If [±lab] second: fails, since it assigns [+lab] to /u, ʊ/, contra D3.
  - iii. If [±cor] second: assigns [+cor] to /i/ and [-cor] to /u, ʊ/.
- d. If [±cor] first: assigns [+cor] to /i/ and [-cor] to all other vowels.
  - i. If [±RTR] second: fails, since it assigns [+RTR] to /ʊ, a, ɔ/ and [-RTR] to /u, e(ə), o/, contra D4.
  - ii. If [±lab] second: fails, since it assigns [+lab] to /u, ʊ/, contra D3.
  - iii. If [[±low] second: assigns [+low] to /e(ə), a, o, ɔ/ and [-low] to /u, ʊ/.

Only (18)c.iii and (18)d.iii satisfy all the desiderata and generate four legitimate orderings which, assuming a fixed ordering [labial] > [RTR],<sup>8</sup> will be reduced to the following two:

---

<sup>7</sup> A natural class is defined here as a set of daughters of the terminal nodes sharing the same node in a given contrastive hierarchy.

<sup>8</sup> This fixed ordering is used only for an expository purpose, since the relative ordering between [labial]

- (19) a. [low] > [coronal] > [labial] > [RTR]  
 b. [coronal] > [low] > [labial] > [RTR]

As of now, the above two orderings are equally plausible for both Oroqen and Khalkha. Note that X. Zhang (1996) and Dresher & Zhang (2005) choose the hierarchy in (a) (at least for Tungusic languages) based on the observation that a two-height distinction is stable throughout the history of the Tungusic languages. If we follow this reasoning, we would assign the same hierarchy in (a) to Khalkha, because all Mongolic languages are analyzed to have a two-height distinction as well.

Now we consider the data showing the minimal contrast between Oroqen and Khalkha labial harmony.

(20) Oroqen: a Tungusic (X. Zhang, 1996)

a. /i/: opaque

tɔŋgorin-tɕəɾə (\*-tɕoro) 'round-DIM'

tɕɔki-wa (\*-wɔ) 'boar-DEF.OBJ'

b. /u, ʊ/: opaque

tɕɔŋko-duləək (\*-dulook) 'window-PLACE.OF.ORIGIN'

dʒɔlɔ-dulaak (\*-dʊlɔək) 'stone-PLACE.OF.ORIGIN'

---

and [RTR] is irrelevant to the current issue. However, recall that for most Tungusic languages (e.g., Written Manchu, Oroch; cf. Nanai) the reverse ordering [RTR] > [labial] explains the vowel patterns better.

(21) Khalkha: a Mongolic (Svantesson et al., 2005)

a. /i/: transparent

poor-ig-o 'kidney-ACC-REFL'

хөөл-ig-о 'food-ACC-REFL'

b. /u, ʊ/: opaque

og-uл-лэ (\*-лo) 'to give-CAUS-DIR.PAST'

ор-ʊл-лэ (\*-лo) 'to enter-CAUS-DIR.PAST'

Once we assign the hierarchy in (19)a to Oroqen and that in (19)b to Khalkha, respectively, the difference between the two follows in a remarkably straightforward manner. Given the hierarchy [low] > [coronal] > [labial] > [RTR], Oroqen /i/ receives the specification [-low, +coronal]. On the contrary, given the hierarchy [coronal] > [low] > [labial] > [RTR], Khalkha /i/ receives the specification [+coronal]. Recall the output specifications given in (11) and (12).

Adopting Mester's (1986) fusional harmony for a height-stratified harmony, the opacity and transparency of Oroqen and Khalkha /i/ can be represented as in (22) and (23), respectively.

(22) Oroqen /i/ (= [-low, +cor]): opaque<sup>9</sup>

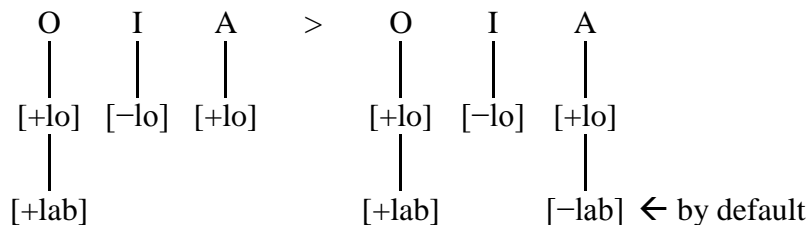

(23) Khalkha /i/ (= [+cor]): transparent

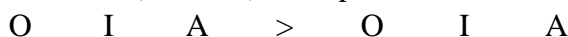

<sup>9</sup> The opacity of /u, ʊ/ in both languages can be explained in the same way.

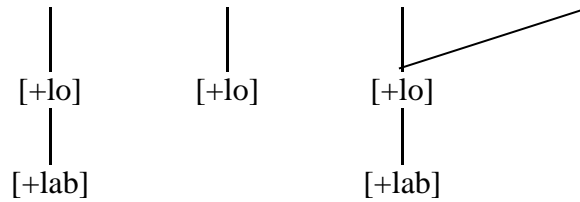

In (22), Oroqen /i/ has the contrastive [-low] specification. Therefore the fusion of the height tier of the preceding and the following vowels specified with [+low] fails to apply. By contrast, In (23), Khalkha /i/ lacks a height feature specification, thus no blocking of the fusional harmony.

The present analysis provides better explanations than the previous analysis by van der Hulst & Smith (1988). First, it offers a unified explanation of the opaque vowels assuming difference in contrastive height specification as the sole cause of the blocking effect by both /i/ (in Oroqen) and /u, ʊ/. Second, the choice of [-low] as the blocking feature fits better for the phonetically-based typological generalizations on labial harmony (Kaun, 2004). Third, /i/ in both languages receives the right specifications with respect to its palatalizing effect. Finally, the same analysis can be applied to other Tungusic and Mongolic languages. For example, the Chakhar vowel system in (6), given the same phonological patterns, is analyzed to have exactly the same contrastive hierarchy as that of Khalkha (cf. §2.2.1.2). Indeed, the entire Tungusic group is characterized with the relative hierarchy [low] > [coronal] while the entire Mongolic group is characterized with the hierarchy [coronal] > [low]. No counterexamples have been found in previous analyses on Tungusic and Mongolic languages (see Chapter 4 and Chapter 2, respectively).

## 5.5. Alternatives

To the best of my knowledge, there have been three distinct previous approaches which specifically deal with the minimal difference between Tungusic and Mongolic vowel harmony: van der Hulst & Smith (1988), Kaun (1995), and Nevins (2010). The basic question across all these analyses is how we can make a transparent vowel invisible with respect to labial harmony process. As we have already seen in §5.2, van der Hulst & Smith (1988) make use of underspecification: Mongolic /i/ is underspecified for the blocking feature, as opposed to Tungusic /i/ which is specified for the same feature. I have shown that this may be intuitively plausible, but their formal solution was not very successful.

The other two approaches use quite different machinery. In her Optimality Theoretic approach,<sup>10</sup> Kaun (1995) claims that Tungusic and Mongolic languages differ from each other in terms of their cut-off points on the putative Transparency Continuum. By contrast, in Nevins's (2010) Search-and-Copy model of vowel harmony, the minimal difference is ascribed to the difference in the relativized search options: Tungusic labial harmony searches for *all* [ $\pm$ round] values, whereas Mongolic labial harmony is relativized only to *marked* [+round] values. Therefore, the unmarked [-round] value of /i/ is visible to the Tungusic search process, whereas it is invisible to the Mongolic search process. I will briefly introduce these two alternative analyses below and compare them with my proposal.

---

<sup>10</sup> For a basic architecture of Optimality Theory, see Kager (1999), McCarthy (2002, 2011), Prince & Smolensky (2004).

### 5.5.1. Kaun (1995)

Kaun (1995) proposes a family of constraints labeled CONTINUITY, each of which identifies a language-specific cut-off point on the proposed Transparency Continuum.

(24) Transparency Continuum (Kaun, 1995, p. 214)

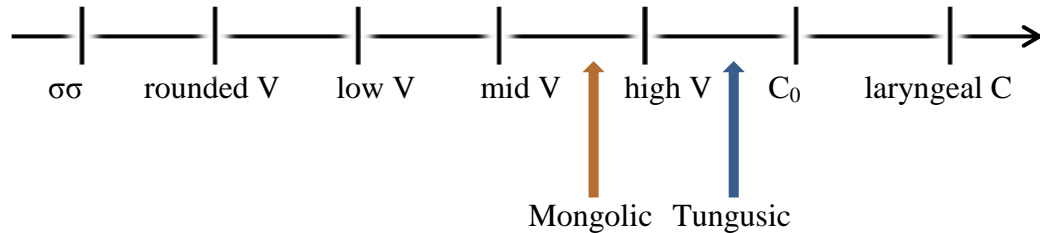

For example, CONTINUITY<sup>C<sub>0</sub></sup> bans any element to the left of C<sub>0</sub> on the Continuum from interrupting a harmonic domain.

The difference between Tungusic and Mongolic labial harmony is then ascribed to different cut-off points. As indicated with upward arrows in (24) above, Tungusic cut-off point is between high V and C<sub>0</sub>, whereas Mongolic cut-off point is between mid V and high V. Therefore, only consonants can be transparent in Tungusic, whereas high vowels (but not other classes of vowels) can also be transparent in Mongolic.

In OT terms, this is formalized with the following constraints:

(25) Definition of constraints

a. CONT<sup>C<sub>0</sub></sup>

No element to the left of “C<sub>0</sub>” may interrupt an extended feature domain.

b. CONT<sup>HighV</sup>

No element to the left of “high V” may interrupt an extended feature domain.

c. EXTEND<sup>R,if<sup>-HI</sup></sup>

The autosegment [+round] must be associated to all available vocalic positions within a word when simultaneously associated with [-high]



d. UNIFORM<sup>R</sup>

The autosegment [+round] may not be multiply linked to slots bearing distinct feature specifications. (Kaun, 1995, p. 142)<sup>11</sup>

The first two constraints designates where the cut-off point is. When CONTINUITY<sup>C0</sup> outranks the relevant EXTEND constraint, EXTEND<sup>Rif<sup>-HI</sup></sup>, which can be understood as the harmonic trigger constraint, only consonants can be transparent and high vowels are opaque, as in Tungusic. In contrast, when CONTINUITY<sup>highV</sup> outranks EXTEND<sup>Rif<sup>-HI</sup></sup>, consonants and high vowels can be transparent, as in Mongolic (p. 224).

This is illustrated with the following tableaux, (26) for Tungusic /i/ and (27) for Mongolic /i/, respectively:

(26) Tungusic /i/: opaque (Kaun, 1995, p. 226)

Input:	A I A	CONT <sup>HighV</sup>	CONT <sup>C0</sup>	UNIFORM <sup>R</sup>	EXTEND <sup>Rif<sup>-HI</sup></sup>
	 [+R]				
a.	A I A ↙ ↘ [+R]			*!	
b.	A I A   [+R]			*!	
c. →	A I A   [+R]				*
d.	A I A ↙ ↘ [+R]	(* <sup>12</sup> )	*!		

<sup>11</sup> A later version of this constraint is called GESTURALUNIFORMITY (Kaun, 2004):  
GESTURALUNIFORMITY

A feature [round] is not dominated by vowels that differ in height.

<sup>12</sup> In Kaun (1995) this cell is marked with one violation mark ‘\*’ plus an exclamation mark ‘!’ which indicates that the violation is fatal. This must be a mistake, since an intervening high ‘unrounded’ vowel will not violate the constraint (CONT<sup>HighV</sup>).

(27) Mongolic /i/: transparent (Kaun, 1995, p. 225)

Input:	A I A	CONT <sup>HighV</sup>	UNIFORM <sup>R</sup>	EXTEND <sup>R</sup> if <sup>-HI</sup>	CONT <sup>C0</sup>
	 [+R]				
a.	A I A ↙ ↘ [+R]		*!		
b.	A I A ∨ [+R]		*!		
c.	A I A   [+R]			*!	
d. →	A I A ↙ ↘ [+R]				*

How about Mongolic and Tungusic /u, ʊ/? The relevant tableaux are not provided in Kaun (1995). However, given the definitions and rankings of the proposed constraints, all rounded vowels (including high rounded vowels /u, ʊ/) cannot be transparent unless CONTINUITY<sup>roundedV</sup> outranks EXTEND<sup>R</sup>if<sup>-HI</sup>.

Technically, this approach works. Note that the proposed Transparency Continuum resembles, at least in part, the sonority hierarchy (cf. Nevins, 2010). The intuition may be that the more sonorous a vowel is, the more likely the vowel is opaque. However, the position of “rounded V” on the Continuum is not well justified in terms of sonority scale or any phonetic/phonological principles, although it is crucial in our discussion on the opacity of high rounded vowels in Tungusic and Mongolic labial harmony. Rather, it seems to me that the Continuum is nothing but a restatement of the observed patterns. As Kaun herself admits, the Transparency Continuum should be understood as “provisional” and needs to be further fleshed out.

Another point that should be made is that the proposed Continuum may overpredict unattested patterns. Imagine that a hypothetical language has a cut-off

point between “σσ” and “rounded V.” Then it is expected that, for instance, long /u:/ is opaque, whereas short /u/ is transparent to labial harmony. Thus, it may face a question of empirical adequacy.

### 5.5.2. Nevins (2010)

In Nevins’s Search-and-Copy model of vowel harmony (Nevins, 2010), harmony is viewed as a target-driven search for the harmonic feature(s) initiated by a “needy” vowel (p. 20). For example, Turkish is well known to have both palatal and labial harmony as exemplified with four-way alternation of the accusative case marker, /-i/ ~ /-İ/ ~ /-ü/ ~ /-u/:

(28) Turkish vowel harmony of accusative suffix (Nevins, 2010, pp. 24–25)

- |    |       |     |       |                |     |       |                |
|----|-------|-----|-------|----------------|-----|-------|----------------|
| a. | /-i/: | ip  | ip-i  | ‘rope-acc.sg’  | el  | el-i  | ‘hand-acc.sg’  |
| b. | /-İ/: | kiz | kiz-i | ‘girl-acc.sg’  | sap | sap-i | ‘stalk-acc.sg’ |
| c. | /-ü/: | yüz | yüz-ü | ‘face-acc.sg’  | köy | köy-ü | ‘villa-acc.sg’ |
| d. | /-u/: | pul | pul-u | ‘stamp-acc.sg’ | son | son-u | ‘end-acc.ag’   |

In Nevins’s approach, the harmony procedure for Turkish accusative case marker is defined as follows:

(29) Turkish accusative case morpheme suffix must:

Back- and Round-Harmonize:  $\delta = \text{left}$ ,  $F = [\pm\text{back}, \pm\text{round}]$

(Nevins, 2010, p. 27)

The above formulation indicates that the search by the needy suffix is done leftwards (“ $\delta$  (direction) = left”) until it finds a value for the features (“F”) [ $\pm\text{back}$ ] and [ $\pm\text{round}$ ]

and copies them to the suffix. This procedure is illustrated with /ip-i/ ‘rope-ACC’ below:<sup>13</sup>

(30) Search-and-Copy procedure for /ip-i/ ‘rope-ACC’ (Nevins, 2010, pp. 27–28)

a. Accusative suffix begins Back- and Round-Harmonize in [ip-i]

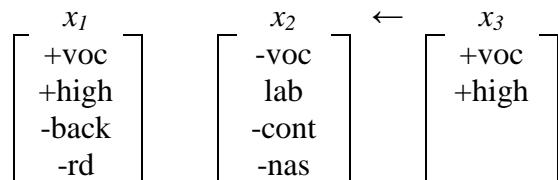

b. Accusative suffix finds [-back] on  $x_1$  and finds [-round] on  $x_1$

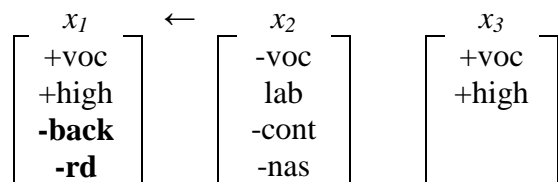

a. Accusative suffix begins Back- and Round-Harmonize in [ip-i]

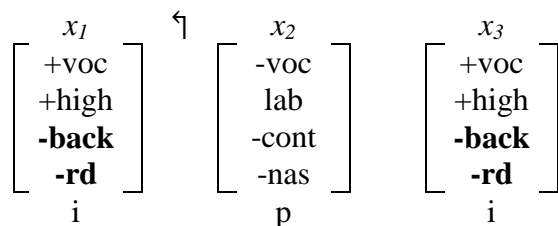

A needy vowel  $x_3$  begins the search leftwards for [ $\pm$ back] and [ $\pm$ round] values. First, as illustrated in (30)a, it encounters  $x_2$  and finds out that it lacks the relevant features. Thus, it moves on to the next and encounters  $x_1$  as in (30)b and copies [-back] and [-round] from  $x_1$  as in (30)c.

<sup>13</sup> The X-slots (e.g.,  $x_1$ ,  $x_2$ ,  $x_3$ ) represent the Root node. The arrow “←” indicates the search direction as well as the current location where the search is being conducted. The symbol “↑” indicates a source from which one or more values are being copied.

Unlike Dresher's contrastive hierarchy theory, Nevins's theory employs full specifications and relativized search options. Thus, all vowels are assumed to be fully specified for all features. Then, the visibility of each vowel is determined by how the harmony process is defined.

Languages may differ from each other in terms of how they relativize their search procedure. Three ways of relativization is proposed as in Visibility Theory (Calabrese, 2005): some rules target *all* feature values, others target only *contrastive* values, and still others target only *marked* values.<sup>14</sup> The relationship among these three classes of accessible feature specifications is diagrammed as subset/superset relations as follows:

(31) Three classes of feature specifications in Visibility Theory (Calabrese, 2005)

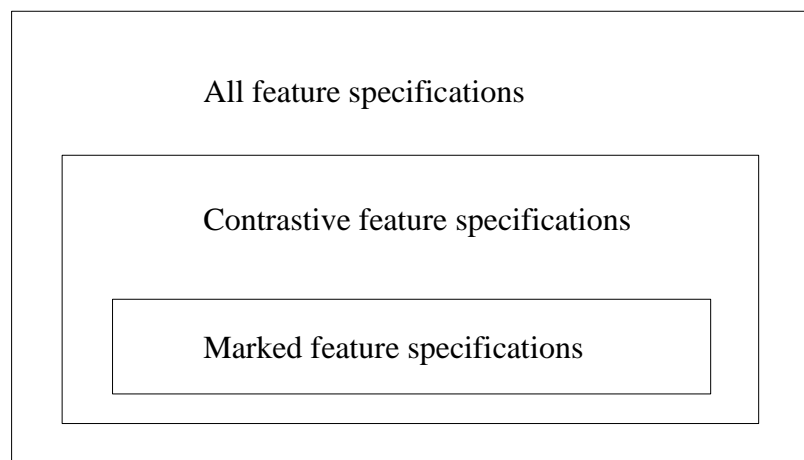

As pointed out by Dresher (2009, p. 237), it would be a major weakening of the Contrastivist Hypothesis if it turns out that phonological rules are allowed to freely access *all* (especially, noncontrastive) feature specifications. Indeed, Nevins argues that the behavioral difference between Khalkha (a Mongolic) and Oroch (a Tungusic)

---

<sup>14</sup> Nevins' definition of *contrastive* is as follows (p. 70):  
A segment S with specification  $\alpha F$  in position P is contrastive for F if there is another segment S' in the inventory that can occur in P and is featurally identical to S, except that it is  $-\alpha F$ .

/i/ is due to the parametric difference in the search option of labial harmony: Khalkha labial harmony targets only *marked* values whereas Oroch labial harmony targets *all* values.

Let us first consider how Nevins (2010) analyzes Khalkha vowel harmony. Nevins presents the following inventory and feature specifications for Khalkha vowels:<sup>15</sup>

(32) Khalkha Mongolian vowel inventory (Nevins, 2010, p. 136; based on Svantesson, 1985)

[-back, -rd]	[+back, +rd]	
i	u	[+high, -RTR]
	ʊ	[+high, +RTR]
e	o	[-high, -RTR]
a	ɔ	[-high, +RTR]

As we have already seen in §2.2.1.1 in a great detail, Khalkha Mongolian has two types of vowel harmony: RTR and labial harmony. According to Nevins, Khalkha RTR harmony is relativized for *contrastive* values, whereas labial harmony is relativized for *marked* values. Recall that Khalkha /i/ is transparent to both RTR and labial harmony. Given the full feature specification in (32), /i/ has neither the *contrastive* value of [ $\pm$ RTR] (because there is no [-RTR] counterpart) nor the *marked* value of [ $\pm$ round] (because it is specified with [-round]). Therefore, it stays invisible to both harmony processes.

---

<sup>15</sup> I will replace his [ $\alpha$ ATR] with [- $\alpha$ RTR] throughout the section for consistency's sake. All the other features remain intact.

Unlike /i/, Khalkha /u, ʊ/ are opaque to labial harmony. This is quite striking because /u, ʊ/ with their [+round] specifications are also matching goals, and thus potential doners. Nevins's solution to this mismatch between the expectation and the actual behavior of /u, ʊ/ is to adopt the notion of *defective intervention* developed in minimalist syntax for Agree (Chomsky, 2000).<sup>16</sup> Nevins argues that, although they are visible in labial harmony due to their marked [+round] values, they are only “defectively” so and thus block harmony. This is illustrated in the interaction between the perfect suffix and the causative suffix below:

(33) Defective intervention in Khalkha [ $\pm$ round] harmony (Nevins, 2010, p. 137)

- a. tor-o:d            ‘be.born-PERF’
- b. ʊr-ʊ:d            ‘enter-PERF’
- c. tor-u:l-e:d        ‘be.born-CAUS-PERF’
- d. ʊr-ʊ:l-a:d        ‘enter-CAUS-PERF’

The search procedures for the two suffixes are formulated as follows:

(34) Khalkha causative suffix /-Ul-/ must: (Nevins, 2010, p. 137)

RTR-Harmonize:  $\delta$  = left, F = [c: RTR]

(35) Khalkha perfect suffix /-A:d/ must: (Nevins, 2010, p. 137)

RTR- and Round-Harmonize:  $\delta$  = left, F = [c: RTR; m: round & R = -high]

---

<sup>16</sup> The notion of *defective intervention* seems to be highly controversial in the field of syntax. See for example Bruening (2012) who claims that there is "no such thing."

According to the harmonic requirement of Khalkha perfect suffix, a copyable source must be marked not just for [+round] but also for [-high]. /i/ is transparent because it has an unmarked [-round] value and hence excluded from search in the first place. By contrast, /u, ʊ/ are marked for [+round] (but not contrastively so) and thus included in search. However, they are specified for [+high] as well, violating the additional requirement that a source should be not just [+round] but also [-high]. Therefore, due to their wrong height, they become defective interveners and block the search. Once blocked, search terminates in failure.

Although in the above analysis Khalkha RTR and labial harmony were viewed as relativized for *contrastive* and *marked* values, respectively, this is not necessarily the case. In particular, labial harmony does not have to be marked-value relativized but could be also contrastive-value relativized if we analyze /e, a/ as [+back, -rd]. In this alternative analysis (which is essentially what I proposed for Khalkha in §2.2.1.1), /o, ɔ/ are contrastively [+rd] since there are [-rd] counterparts /e, a/. However, although /u, ʊ/ have marked specifications for [+rd], they are not contrastively [+rd] since there are no [-rd] counterparts which share all other feature values with /u, ʊ/. If the blocking effect of /u, ʊ/ can be ascribed to some other factor than the proposed defective intervention effect, then this can be thought of as a viable option. Note also that this alternative feature specifications is better in the sense that /i/ is treated as the only [-back] vowel, which can explain its palatalizing effect.

Now let us move on to Oroch, a Tungusic language, which is assumed to have the following inventory and feature specifications:



(36) Oroch vowel inventory (Nevins, 2010, p. 112; based on Tolskaya, 2008)

[-back, -rd]	[+back, -rd]	[+back, +rd]	
i		u	[+high, -RTR]
		ʊ	[+high, +RTR]
æ	ə		[-high, -RTR]
	a	ɔ	[-high, +RTR]

As discussed earlier, all high vowels in Oroch (and other Tungusic languages) block labial harmony. According to Nevins, this is because Oroch employs different search option: labial harmony in Oroch is relativized to *all* values of [ $\pm$ round] as exemplified in the harmony rule in (37). This contrasts with Khalkha labial harmony which is relativized only to *marked* [+round] values.

(37) Oroch accusative suffix, focus suffix must: (Nevins, 2010, p. 140)

RTR- and Round-Harmonize:  $\delta$  = left, F = [c: RTR;  $\pm$ round & R = -high]

Therefore, all high vowels are visible in search and become defective interveners because of their [+high] specifications. This is illustrated with the following examples:

(38) Oroch rounding harmony blocked by [+high] vowels (Nevins, 2010, p. 140)<sup>17</sup>

- a. ɔtɔŋgɔ-vɔ-dɔ ‘kayak-ACC-FOC’
- b. ɔtɔŋgɔ-dʊ-da ‘kayak-DAT-FOC’
- c. ɔtɔŋgɔ-ni-da ‘kayak-3SG-FOC’

---

<sup>17</sup> These examples are (perhaps mistakenly) cited as ɔtɔŋgɔ-vɔ-dɔ, ɔtɔŋgɔ-dʊ-da, ɔtɔŋgɔ-ni-dɔ in Nevins (2010, p. 140). They are corrected here based on Tolskaya (2008).

Nevins's analysis of Khalkha and Oroch presents a challenge to the Contrastivist Hypothesis since it assumes that Khalkha and Oroch labial harmony have access to noncontrastive feature specifications. Given the feature specifications in (32) and (36), the high rounded vowels /u, ʊ/, although marked with [+round], are all noncontrastive since there are no [-round] counterparts.<sup>18</sup> Nevertheless, they are all visible since the search is relativized to *marked* (in Khalkha) or *all* values (in Oroch). Similarly, the noncontrastive [-round] specification of Oroch /i/ is also viewed as phonologically active (visible) due to the *all*-value relativization in Oroch. It seems to me that this situation is not an inevitable conclusion drawn from the phonological patterns but an artifact stemming from Nevins's framework which identifies blocking effect with defective intervention effect: in order to make blocking as defective intervention work, it is required within the framework that even the noncontrastive [±round] values of /i, u, ʊ/ should be visible. My contrastive hierarchy-based approach in §5.4 stands in stark contrast to Nevins's. It allows us much simpler treatment while maintaining the Contrastivist Hypothesis intact: in my analysis, the only feature value relevant to the blocking effect by /i, u, ʊ/ is contrastive [+high] (= [-low]), whereas their [±labial] specifications are not contrastive and thus totally irrelevant.

Nevins's analysis also includes other unnecessary complications to explain other aspects of Tungusic vowel harmony: (i) set union of the contrastive and the marked values and (ii) sonority-driven barrier. First, the vowel /ɔ/ in Oroch requires a special treatment in Nevins's approach. Given the vowel inventory in (36), the [+RTR] value of /ɔ/ is not contrastive since there is no [-RTR] counterpart. This noncontrastive value should be invisible to the search because the Oroch RTR harmony is relativized to

---

<sup>18</sup> This situation leads Nevins to the conclusion that “the set of marked values and the set of contrastive values in an inventory are not always in a subset/superset relation.” (p. 111)

contrastive values, as can be seen in (37). However, this is contradictory to the attested pattern in (38): when labial harmony is blocked, /ɔ/ still spreads its [+RTR] value to the suffix vowel (e.g., *ɔtɔŋgɔ-dɔ-da* ‘kayak-DAT-FOC’). This is problematic, since [+RTR] is the marked value in Oroch as Nevins correctly assumes (p. 112). Nevins’s solution to this problem is to assume that the Oroch RTR harmony is relativized to the “set union” of the *contrastive* and the *marked* values. As /u, ʊ, ə, a/ are contrastive and /ʊ, a, ɔ/ are marked for [±RTR], set union for the set of vowels with contrastive [±RTR] values and the set of vowels with marked [+RTR] vowels will include /u, ʊ, ə, a, ɔ/ but exclude /i, æ/ from the search procedure (p. 112).<sup>19</sup> It follows then that the marked [+RTR] value of /ɔ/, albeit noncontrastive, is visible and copiable, whereas the [-RTR] value of /i, æ/, being unmarked as well as noncontrastive (thus excluded from the set union), is invisible. In my analysis, however, /ɔ/ is contrastively [+RTR] as well as [+round] under the relative ordering [RTR] > [round], even though there is no [-RTR] counterpart. On the other hand, /i, æ/ lack contrastive [-RTR] value due to the relative ordering [coronal] > [RTR] and hence are invisible to RTR harmony.

Another example of unnecessary complications is Nevins’s analysis of Written Manchu (Nevins, 2010, pp. 172–176), which is assumed to have the following vowel inventory:

---

<sup>19</sup> This notion of set union is not properly reflected in (37). We may simply use “ $c \cup m$ ” to denote the set union as in the following:

RTR-Harmonize and Round-Harmonize:  $\delta = \text{left}$ ,  $F = [c \cup m: \text{RTR}; \pm\text{round} \ \& \ \text{R} = \text{-high}]$

(39) Written Manchu vowel inventory (Nevins, 2010, p. 173)

[-back, -rd]	[+back, -rd]	[+back, +rd]	
i		u	[+high, -RTR]
		o	[+high, +RTR]
	ə		[-high, -RTR]
	a	ɔ	[-high, +RTR]

Nevins first proposes the following RTR harmony rule:<sup>20</sup>

(40) RTR-Harmonize:  $\delta = \text{left}$ ,  $F = [\text{m: RTR}]$  (Nevins, 2010, p. 174)

The above rule, which is relativized only to the marked [+RTR] value, predicts that /u/ with no marked [+RTR] value would pattern as a transparent vowel.<sup>21</sup> This prediction seems to be borne out:

(41) Written Manchu transparent /u/ in harmony (Nevins, 2010, p. 175 with necessary modifications; data drawn from X. Zhang, 1996)

<i>dacu-kan</i>	[daʃʊkan]	‘somewhat sharp’
<i>gūsū-la-</i>	[gʊsʊla]	‘tie up with thick rope’
<i>hūdu-ngga</i>	[χʊduŋga]	‘speedy’

<sup>20</sup> Following Zhang (1996), Nevins assumes that the last-resort value for Written Manchu is [+RTR] (p. 174). However, as discussed in §4.2.1.1.4, this seems to be wrong.

<sup>21</sup> Recall that /u/ in Written Manchu is not an ‘across-the-board’ neutral vowel. Rather, it is neutral only in non-post-dorsal contexts. Thus, its partial neutrality should be viewed as the result of contextual neutralization. One way to achieve this result is a rule ordering (“counterbleeding”) within a rule-based framework: a vowel harmony rule followed by a neutralization rule whereby the two underlying vowels /u/ and /o/ are neutralized to [u] except after dorsal consonants.

However, according to the harmony rule, it is not just /u/ but also /ə/ that will be treated invisible, since /ə/ also has an unmarked [-RTR] value. To make sure that search halts with /ə/ but not with /u/, Nevins appeals to the sonority difference between /u/ and /ə/.

(42) RTR-Harmonize:  $\delta = \text{left}$ ,  $F = [\text{m: RTR}]$ ,  $\zeta = 6$  (Nevins, 2010, p. 175)

The threshold parameter  $\zeta$  indicates that the search for a marked [+RTR] value is restricted to those vowels whose sonority does not exceed level 6. Note that Nevins follows Gouskova (2004) in assuming that the threshold is selected on a language-specific basis, although the sonority scale itself may be universal.

(43) Sonority levels (Nevins, 2010, p. 171; based on Parker, 2002)

Segments	Sonority level	Relevant features
a, ä, ɒ	8	[+low, -ATR]
ə	7	[+low, +ATR]
ɛ, ɔ	6	[-low, -ATR]
e, o	5	[-low, +ATR]
ɪ, ʊ	4	[+high, -ATR]
i, u	3	[+high, +ATR]
y, w	2	[+high, +ATR, -voc, -cons]
sonorant consonants	1	[+son, +cons]

This particular implementation, however, is almost certainly too powerful, since it overgenerates unattested (and likely impossible) grammars. Taking only one such

example, a hypothetical language may have a labial harmony rule with 3 as the threshold parameter value ( $\zeta = 3$ ).

(44) Round-Harmonize:  $\delta = \text{left}$ ,  $F = [\text{m: round}]$ ,  $\zeta = 3$  (a hypothetical language)

A prediction about this language is that /i, u/ (sonority level = 3) would be transparent while /ɪ, ʊ/ (sonority level = 4) opaque. However, it is highly unlikely that we may find this type of language.

Finally, I would like to emphasize that, in my contrastive hierarchy analyses of Tungusic and Mongolic vowel harmony presented in the previous section (as well as in the previous chapters), all the machineries adopted by Nevins (value-relativization, set union, sonority threshold) are simply unnecessary.<sup>22</sup> Crucially, the “microvariation” between Tungusic and Mongolic /i/ is not the result of the different visibility setting but the result of the different feature ordering. The Contrastive Hypothesis that only contrastive features operate in phonological computation is maintained intact.

Then, this result challenges the central tenets of Visibility Theory: Is it really necessary to assume that phonological process may be relativized to *all*-, *contrastive*-, and *marked*-values? The answer seems negative. Another major example, the microvariation between Ifẹ Yoruba (*contrastive*-value sensitive) vs. Standard Yoruba (*all*-value sensitive) vowel harmony (Nevins, 2010, pp. 103–5) has recently been reanalyzed by Dresher (2011) as the result of different feature orderings.

---

<sup>22</sup> However, his Search-and-Copy model may be compatible with the modified contrastive specification in my analyses.

## 5.6. Conclusion

This chapter has shown that the microvariation between Tungusic and Mongolic labial harmony (van der Hulst & Smith, 1988) can be modeled in terms of the minimal difference in the contrastive hierarchy (Dresher, 2009), i.e., Tungusic [low] > [coronal] > [labial] > [RTR] (Zhang 1996) vs. Mongolic [coronal] > [low] > [labial] > [RTR] (§2.2.1.1). These hierarchies assign the right specifications for the Tungusic “opaque” /i/ and the Mongolic “transparent” /i/. Since Mongolic /i/ receives no contrastive height specification, it is invisible, thus transparent, to the “height-stratified” labial harmony (cf. Mester, 1986). The result is a strong piece of empirical support for the contrastive hierarchy approach, as well as a better solution to a well-known problem in the theory of harmony systems.

One additional remark: there has been an issue as to which feature, a place feature or a height feature, comes first. Some argue for height contrasts universally precede place contrasts (Jakobson & Halle, 1956; Trubetzkoy, 1969), while others argue for the opposite (Ghini 2001 as in (45) below). Cf. Dresher & Zhang (2005, fn. 13).

(45) Place of Articulation First (Ghini, 2001, p. 155):

Place of articulation features are assigned before height features.

The Tungusic and Mongolic data may suggest that there is no universally fixed order between the two features: either place or height feature can come first.

## CHAPTER SIX

### CONCLUSION

In this concluding chapter, I first summarize the major findings and claims addressed in the main chapters and briefly discuss the implication of my analysis on the Proto-Altaic vowel system. Then a typological sketch of the Altaic vowel systems including a comparison of non-Turkic languages with Turkic languages will follow.

#### **6.1. The original vowel contrast in Altaic languages**

The point of departure of this dissertation was the following two core questions:

Q1: Was RTR (Retracted Tongue Root) the original contrast in Korean, Mongolic, and Tungusic languages?

Q2: How have these original vowel systems evolved through time? How can we explain the shift from an RTR to a palatal harmony as found, for example, in some varieties of Mongolic?

To answer these questions, I explored the phonetics and phonology of the tongue root contrast in Mongolic, Korean, and Tungusic languages and demonstrated that all these languages originally had an RTR-based vowel system eliminating the necessity of the Mongolic and Korean vowel shift hypothesis altogether. Many Mongolic and Tungusic languages still retain the original RTR contrast. However, we have also seen certain changes in the vowel contrast and the inventory in some Mongolic and Tungusic languages (e.g., Monguor type Mongolic and modern Manchu varieties) and



the Korean language. These changes which include the loss of RTR contrast along with certain vowel phonemes and the creation of new vowel phonemes were explained in terms of the changes in the contrastive feature hierarchy. The alleged shift from an RTR to a palatal harmony in Kalmyk and Oirat was treated as a reinterpretation of redundant F2 difference accompanied by the original RTR contrast as contrastive.

To be more specific, in Chapter 2, I argued that, contra the conventional assumption (i.e., Poppe 1955), RTR was the original contrast of Old Mongolian (and Proto-Mongolic as well) and that the vocalic history of Mongolic from Old Mongolian to modern varieties is better explained within the framework of contrastive hierarchy coupled with an RTR analysis of OM, contra Svantesson's (1985) palatal-to-RTR vowel shift hypothesis.

In Chapter 3, I presented an innovative view that Middle Korean (and arguably Old Korean as well) had an RTR contrast-based vowel system and that various issues in the Korean historical phonology receive better treatment under the contrastive hierarchy approach. In addition, using the RTR analysis of Old Mongolian as primary evidence, I demonstrated that Ki-Moon Lee's Korean vowel shift hypothesis, a deeply entrenched view among Koreanists since the 1960s, has no solid basis.

In Chapter 4, I attempted contrastive hierarchy analyses of the Tungusic languages, although the phonological patterns of some Tungusic languages have not been well documented. Along the lines of J. Kim (1989, 1993), B. Li (1996), X. Zhang (1996), Drescher & Zhang (2005), I argued that RTR was also the original contrast in Tungusic based on my RTR analysis of modern Tungusic languages.

In Chapter 5, my focus has been on the theoretical issues. One issue was how to explain the transparent/opaque vowels in vowel harmony. Maintaining a strong version of the Contrastivist Hypothesis (D. C. Hall 2007) which holds that only contrastive features are computed in the phonology (contra Visibility Theory), I

specifically gave a simple but elegant account of the minimal difference between Tungusic and Mongolic labial harmony.

It has long been assumed that Proto-Altaic had a palatal contrast-based vowel system. For example, Poppe (1960a, as cited in Vaux 2009) reconstructed the following 9-vowel system for Proto-Altaic, which resembles many contemporary Turkic vowel systems. This reconstruction is based on the palatal analysis of Turkic and Mongolic languages.

- (1) The reconstructed Proto-Altaic vowel system (Poppe, 1960a, p. 92, as cited in Vaux 2009)

	[front]		[back]	
	[-round]	[+round]	[-round]	[+round]
[closed]	i	y	ɨ	u
[middle]	e	ø		o
[open]	ɛ		a	

However, given that the original contrast in Mongolic, Tungusic, and Korean was all based on [RTR], we reach the conclusion that Proto-Altaic (whether we assume Micro- or Macro-Altaic) is likely to have had an RTR system as illustrated below.

(2) An RTR analysis of Proto-Altaic (cf. Vaux, 2009)

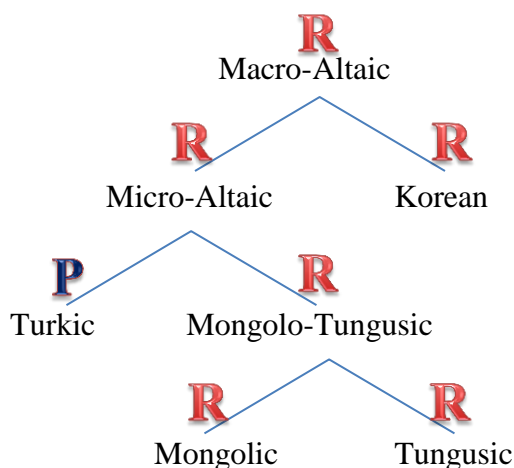

Then, the result is a strong support to Vaux’s claim that “the Altaic protolanguage must have employed an [atr] harmony system similar to those found in the Tungusic and Mongolic languages” and that “the Turkic palatal system is easily derived from this by a set of phonetic and phonological principles paralleled in numerous and diverse languages of the world” (Vaux, 2009). (See also B. Li 1996, pp. 339ff.)

## 6.2. Contrast-driven typology of vowel systems in Altaic Languages

### 6.2.1. Inventory-driven typology of Altaic vowels

#### 6.2.1.1. Universals in vowel systems

As noted by Maddieson (Maddieson, 1999, p. 2523), the conventional typological studies have devoted their attention almost exclusively to analyzing the structure of phoneme inventories “since even the relatively modest publications which are all that is available for most languages usually include a phonemic level of analysis.” Let us take two representative works of this sort, Crothers (1978) and Maddieson (1984).

Both seek typological generalizations based on large copora of vowel inventories: 209 languages in the Stanford Phonology Archives (SPA) and 317 languages in the UCLA Phonological Segment Inventory Database (UPSID),<sup>1</sup> respectively.<sup>2</sup> These works confirm well-known preferences for, e.g., symmetrical/ peripheral vowel systems and rounded back (and unrounded front) vowels. They are also concerned about certain “numbers” of vowels: for example, Table 2, taken from Maddieson (1984), shows that (i) the smallest number of vowel qualities in a languages is 3, (ii) the most common number is 5, and (iii) almost two-thirds of the languages have 5 to 7 vowel qualities (p. 128).

No. of vowel qualities	No. of languages	Percent of languages
3	17	5.4 %
4	27	8.5 %
5	98	30.9 %
6	60	18.9 %
7	47	14.8 %
8	17	5.4 %
9	25	7.9 %
10	15	4.7 %
11	2	0.6 %
12	5	1.6 %
13	2	0.6 %
14	0	0.0 %
15	2	0.6 %

Table 2. Number of vowel qualities<sup>3</sup> (Maddieson, 1984, p. 127)

<sup>1</sup> UPSID has been extended by Maddieson & Precoda (1990) to include 451 languages and further extended by Lindblom, Krull, & Stark (1992) to include 534 languages (SUPERB UPSID).

<sup>2</sup> SPA includes 1 Mongolic (Khalkha), 1 Tungusic (Ewenki), 3 Turkic (Chuvash, Kirghiz, Turkish), and 1 Korean (Korean) languages; UPSID includes 1 Mongolic (Khalkha), 3 Tungusic (Ewenki, Goldi(Nanai), Manchu), 8 Turkic (Azerbaijani, Bashkir, Chuvash, Khalaj, Kirghiz, Turkish, Tuva, Yakut), and 1 Korean (Korean).

<sup>3</sup> Note that this is not the same as the count of vowel phonemes. If a hypothetical language has three phonemic oral vowels /i, a, u/ and three phonemic nasal vowels /ĩ, ã, û/, the number of vowel phonemes is six while the number of vowel qualities is three. The number of vowel qualities might be a more appropriate measure in a typological comparison of vowel systems than the number of vowel phonemes, since the former indicates the extent to which “the most basic parameters of vowel contrast (height, backness, rounding) are being used” (Maddieson, 1984, p. 128).

In addition, as observed by Crothers (1978), we might find some implicational universals (3) which serve as the basis of the hypothesized vowel hierarchy (4).

(3) Implicational universals (Crothers, 1978, pp. 115–6)

- a. All languages have /i a u/.
- b. All languages with four or more vowels have /i ε/.
- c. Languages with five or more vowels have /ε/. They generally also have /ɔ/.
- d. Languages with six or more vowels have /ɔ/ and also either /i/ and /e/.
- e. Languages with seven or more vowels have /e/ and /o/, or /i/ and /ə/ (/ü/ and /ö/ may represent the types /i/ and /ə/).
- f. Languages with eight or more vowels have /e/.
- g. Languages with nine or more vowels generally have /o/.

(4) Vowel hierarchy (Crothers, 1978, p. 114)

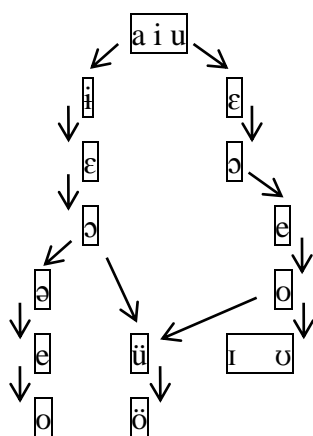

A notable improvement was made in Mielke’s P-base database with 500+ languages (Mielke, 2008) based on which the cross-linguistic frequency of an individual vowel phoneme was visualized as area containing an IPA symbol as follows:

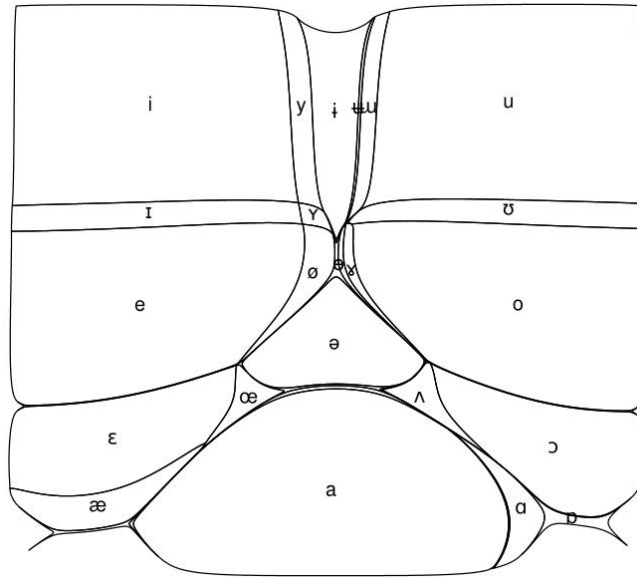

Figure 8. Short oral vowels by frequency in P-base (represented by the area) taken from <http://aix1.uottawa.ca/~jmielke/pbase/index.html>

### 6.2.1.2. Intra-Altaic typology of vowel inventories

Table 3 is the result of a comprehensive survey of the vowel inventories in the Altaic languages. A more detailed list (with the vowel qualities and references) can be found in the Appendix.

No. of vowel qualities	No. of languages (M/Tg/Tk/K)	Percent of languages	Language (M: Mongolic, Tg: Tungusic, Tk: Turkic, K: Korean)
5	7 (5/2/0/0)	10.1 %	Monguor <sup>M</sup> , Santa <sup>M</sup> , Bonan <sup>M</sup> , Moghol <sup>M</sup> , Dagur <sup>M</sup> , Udihe <sup>Tg</sup> , Literary Ewenki <sup>Tg</sup>
6	7 (1/2/2/2)	10.1 %	Khamnigan <sup>M</sup> , NW Korean <sup>K</sup> , SE Korean <sup>K</sup> , Written Manchu <sup>Tg</sup> , Najkhin Nanai <sup>Tg</sup> , Uzbek <sup>Tk</sup> , Halič Karaim <sup>Tk</sup>
7	9 (3/3/2/1)	13.0 %	Khalkha <sup>M</sup> , Buriat <sup>M</sup> , Old Mongolian <sup>M</sup> , Middle Korean <sup>K</sup> , Spoken Manchu <sup>Tg</sup> , Oroch <sup>Tg</sup> , Xunke Oroqen <sup>Tg</sup> , Khalaj <sup>Tk</sup> , (Fuyu Kirghiz <sup>Tk</sup> )
8	27 (2/6/19/1)	39.1 %	Khalmyk <sup>M</sup> , Oirat <sup>M</sup> , Early Middle Korean <sup>K</sup> , Sibe <sup>Tg</sup> , Ulchi <sup>Tg</sup> , (Baiyinna) Oroqen <sup>Tg</sup> , Ewen <sup>Tg</sup> , Solon <sup>Tg</sup> , Negidal <sup>Tg</sup> , Chuvash <sup>Tk</sup> , Turkish <sup>Tk</sup> , Gagauz <sup>Tk</sup> , Turkmen <sup>Tk</sup> , Salar <sup>Tk</sup> , Crimean Tatar <sup>Tk</sup> , (Caucasian) Urum <sup>Tk</sup> , Karaim <sup>Tk</sup> , Karachai-Balkar <sup>Tk</sup> , Kumyk <sup>Tk</sup> , Kirghiz <sup>Tk</sup> , Altai <sup>Tk</sup> , Shor <sup>Tk</sup> , (Middle) Chulym <sup>Tk</sup> , Tuvan <sup>Tk</sup> , Tofa <sup>Tk</sup> , Yakut <sup>Tk</sup> , Dolgan <sup>Tk</sup> , Yellow Uyghur <sup>Tk</sup>
9	11 (1/0/10/0)	15.9 %	Kanjia <sup>M</sup> , Old Turkic <sup>Tk</sup> , Azerbaijani <sup>Tk</sup> , Azari <sup>Tk</sup> , Uyghur <sup>Tk</sup> , Tatar <sup>Tk</sup> , Bashkir <sup>Tk</sup> , Kazakh <sup>Tk</sup> , Karakalpak <sup>Tk</sup> , Noghay <sup>Tk</sup> ,

			Khakas <sup>TK</sup>
10	5 (1/1/0/3)	7.2 %	Shira Yugur <sup>M</sup> , Uilta <sup>Tg</sup> , NE Korean <sup>K</sup> , SW Korean <sup>K</sup> , Central Korean <sup>K</sup>
11	1 (1/0/0/0)	1.4 %	Baarin <sup>M</sup>
12	1 (0/0/0/1)	1.4 %	Jeju Korean <sup>K</sup>
13	0 (0/0/0/0)	0.0 %	
14	1 (1/0/0/0)	1.4 %	Chakhar <sup>M</sup>
Total	69 (15/14/33/8)	100.0 %	

Table 3. Intra-Altaic typology of vowel qualities

Basic observations are as follows:

- (5) Basic observations
- a. The smallest number of vowel qualities in Altaic is 5.
  - b. The most common number is 8. The second-most and the third-most common numbers are 9 and 7, respectively.
  - c. Over 95% of the Altaic languages have between 5 and 10 vowel qualities
  - d. Languages with more than 10 vowel qualities are exceptionally rare.<sup>4</sup>
  - e. Almost all the Turkic languages have a 8- or 9-vowel system, with the exception of Uzbek (with a 6-vowel system) and Khalaj and Fuyu Kirghiz (with a 7-vowel system).
  - f. The maximum number of vowels in Turkic is 9.<sup>5</sup>

<sup>4</sup> There are only three languages in this category: Baarin, Chakhar, and Jeju Korean. (Note that Chakhar has a 14-vowel system which was absent in UPSID. See Table 2.) This is basically due to the unlauded vowels. Scholars may have different opinions about these vowels. All 10-vowel systems such as Shira Uyghur, Uilta, and three modern dialects of Korean (Northeast, Southwest, Central Korean) contain unlauded vowels.

<sup>5</sup> This is in contrast with non-Turkic Altaic languages in which later development of unlauded front vowels is not uncommon. Note that a canonical Turkic language such as Turkish fully exploits the front vowel region whereas a canonical Tungusic/Mongolic language (cf. Middle Korean) such as Ewen and Khalkha has an asymmetrical vowel inventory with no non-high front vowels.

Although the inventory-driven typology of the Altaic vowel systems reveals some interesting tendencies as addressed above, it cannot capture the typological as well as genetic affinity of languages in terms of the formal property of vowels, i.e., vowel contrast. For example, when we compare the three vowel systems of Xunke Oroqen (a Tungusic), Khalkha (a Mongolic), and Chakhar (a Mongolic), an inventory-driven analysis would classify the 7-vowel systems of Oroqen and Khalkha into one group and the 14-vowel system of Chakhar into the other group. However, this classification may be misleading: it does not fit for the genetic classification nor is suitable to capture the subtle dissimilarity between the Tungusic (Oroqen) and the Mongolic (Khalkha and Chakhar) vowel patterns (e.g., transparency/opacity of /i/).

(6) Vowel inventories of Oroqen, Khalkha, and Chakhar

a. Oroqen (Tung)	b. Khalkha (Mong)	c. Chakhar (Mong)
i      u	i      u	i    y      u
		ɪ    ʏ      ʊ
ə    o	e      o	e    ø    ə    o
a    ɔ	a      ɔ	ɛ    œ    a    ɔ

By contrast, under the contrast-driven typology I adopt, we will not have this problem, because seemingly dissimilar inventories (e.g., Khalkha 7-vowel system and Chakhar 14-vowel system) can receive the same contrastive hierarchy analysis whereas similar inventories (e.g., Khalkha and Oroqen 7-vowel systems) can also be treated as distinct types with different feature hierarchies. This contrast-driven classification seems to correctly reflect the genetic/geographical affinity between languages. It is also shown that the current contrast-driven typology provides a reasonable account for the



synchronic variation and diachronic changes of certain vowel systems in terms of the changes in the contrastive hierarchy. In addition, the current contrast-driven typology provides a plausible account for the inventorial difference between Turkic vs. non-Turkic systems. All these, which will be discussed in the next section, are not achievable within the traditional, inventory-driven typological approaches.

### 6.2.2. Contrast-driven typology of Altaic vowels

In the previous chapters, we established a *contrastive hierarchy* for each non-Turkic Altaic vowel system based on the phonological behavior as well as the phonetic quality of vowels. Here is the summary of what we have found.

#### (7) Mongolic vowel systems

Language	Contrastive hierarchy
a. Mongolian Proper (e.g., Khalkha)	[coronal]>[low]>[labial]>[RTR]
b. Monguor, Santa, Bonan, Moghol	[coronal]>[low]>[labial]
c. OM, Dagur, Buriat, Khamnigan	[coronal]>[labial]>[RTR](>[low])
d. Kalmyk, Oirat	[coronal]>[low]>[labial]>[dorsal]

#### (8) Korean vowel systems

Language	Contrastive hierarchy
a. Middle Korean	[coronal]>[low]>[labial]>[RTR]
b. Early Modern Korean; NW Korean	[coronal]>[high]>[low](>[labial])
c. Central Korean; SE Korean	[coronal]>[low]>[labial](>[high])
d. Jeju Korean	[coronal]>[high]>[labial]>[low]

(9) Tungusic vowel systems

Language	Contrastive hierarchy
a. W. Manchu, Oroch, Udihe Ulchi, Uilta, Oroqen, Ewenki, Solon, Ewen	[low]>[coronal]>[RTR]>[labial] <sup>6</sup>
b. Nanai	[low]>[coronal]>[RTR]
c. Spoken Manchu, Xibe	[low]>[coronal]>[labial]

There are notable similarities and dissimilarities among these three groups. First, we notice that all canonical Mongolic, Tungusic, and Korean employs four contrastive features, namely [coronal], [low], [labial], and [RTR]. Even those languages which have only three contrastive features seem to have had once four contrastive features. Second, as discussed in greater detail in Chapter 5, there is a minimal but systematic difference between the Mongolic and Tungusic branches with respect to the relative ordering between [coronal] and [low]: i.e., [coronal] > [low] in Mongolic vs. [low] > [coronal] in Tungusic. We have seen that this minimal difference in the feature hierarchy captures the contrast between the transparency of Mongolic /i/ vs. the opacity of Tungusic /i/ to labial harmony.

In Korean (especially, in Middle Korean), on the other hand, the relative hierarchy between these two features are not crucially determined, although I assumed that

---

<sup>6</sup> In Chapter 5, Oroqen, Ewenki, Solon, Ewen, and Uilta were assigned [low] > [coronal] > [labial] > [RTR] following the previous analysis of Oroqen in the contrastive hierarchy literature (Zhang 1996, Dresher and Zhang 2005). However, as I mentioned in the chapter, the reversed ranking [RTR] > [labial] also works well. Rather, in some languages such as Written Manchu and Oroch, the relative ranking between the two contrastive features must be [RTR] > [labial]. A thorough investigation of the historical merger pattern of /o/ in Tungusic may be revealing which is more plausible under the assumption that /o/ would have merged with /ɔ/ under the ranking [labial] > [RTR] whereas /o/ would have merged with /ə/ under the ranking [RTR] > [labial]. However, this line of research has not been done in the present thesis.

[coronal] is ordered ahead of [low] considering the change in the number of height distinction in its vocalic history: the two-way height distinction in Middle Korean changed into the three-way height distinction in Early Modern Korean and Contemporary Korean. Then, in SE Korean, the three-way distinction reduces back to the two-way distinction. By contrast, the two-way height distinction is very stable, in other Altaic vowel systems including Mongolic, Tungusic, and as we will see shortly, Turkic as well. Another notable difference between Korean and other languages is found in the inventory: Middle Korean exploits the high back region for the labial contrast (/i, ʌ/ vs. /u, o/) instead the low back region (/ə, a/ vs. /o, ɔ/). Therefore, Middle Korean had had only two rounded vowels while canonical Mongolic, Tungusic, and Turkic languages normally have four rounded vowels.

Now, consider the Turkic contrastive hierarchies presented below:

(10) Turkic vowel systems<sup>7</sup>

Language	Contrastive hierarchy <sup>8</sup>
a. Most Turkic langs (e.g., Turkish)	[low]≈[labial]≈[dorsal]
cf. Kazakh (Vajda, 1994)	[low]≈[labial]≈[RTR]
b. Uyghur	[low]≈[labial]>[dorsal]

Most Turkic languages in (10)a have symmetrical vowel inventories.<sup>9</sup> A canonical example is Turkish as shown below:

---

<sup>7</sup> Some of the following hierarchies are preliminary in nature due to insufficient descriptions on the phonological patterns of the relevant languages.

<sup>8</sup> The symbol “≈” indicates that there is no positive evidence in favor of one hierarchy over the other.

<sup>9</sup> Here I exclude /e/ (so-called “closed ě”) from the analysis of 9-vowel Turkic vowel systems since it is a variant of /e/ in most modern Turkic languages with a limited distribution and thus its phonemic status is highly debated (Johnson 1998, p. 89).

(11) Turkish vowel system (cf. Dresher, 2009, p. 184)

		[dorsal]	
	[lab]		[lab]
i	y	ɨ	u
ε	ø	a	o [low]

As Dresher points out, all vowels take up all the space of possible values for the assumed three features. Therefore, all feature values, including [±labial] values, are contrastive for all vowels. This is supported by the fact that all [+labial] vowels trigger labial harmony in these languages.

Uyghur lacks an equivalent to /i/, thus having the following 7-vowel system.<sup>10</sup>

(12) Uyghur vowel system (cf. Vaux, 2000)

		[dorsal]	
	[lab]		[lab]
i	y		u
ε	ø	a	o [low]

Unlike the canonical Turkish system where all vowels participate in palatal harmony, Uyghur has a neutral vowel /i/ which is transparent to the vowel harmony. This is illustrated by the examples in (13) and (14) below:<sup>11</sup>

<sup>10</sup> Again, I excluded /e/ from the inventory.

<sup>11</sup> Labial harmony is not considered here.

(13) Uyghur palatal harmony (Lindblad, 1990, p. 17, as cited in Vaux, 2000)

sg.	pl. -lAr-	dat. -GA-	1sg poss. -Vm-	gloss
yol	yollar	yolka	yolum	‘road’
pul	pullar	pulka	pulum	‘money’
at	atlar	atqa	etim	‘horse’
köl	köllär	kölgä	kölüm	‘lake’
yüz	yüzlär	yüzgä	yüzüm	‘face’
xät	xätlär	xätkä	xetim	‘letter’

(14) Uyghur /i/ is transparent to palatal harmony

sg.	1pl poss. -ImIz-	-ImIz-GA-	gloss
yol	yolimiz	yolimizka	‘road’
pul	pulimiz	pulimizka	‘money’
köl	kölimiz	kölimizgä	‘lake’
yüz	yüzimiz	yüzimizgä	‘face’

The transparency of /i/ can be achieved by putting [dorsal] at the bottom of the hierarchy as follows (here I assume [low] > [labial]):

(15) Uyghur contrastive hierarchy: [low] > [labial] > [dorsal]

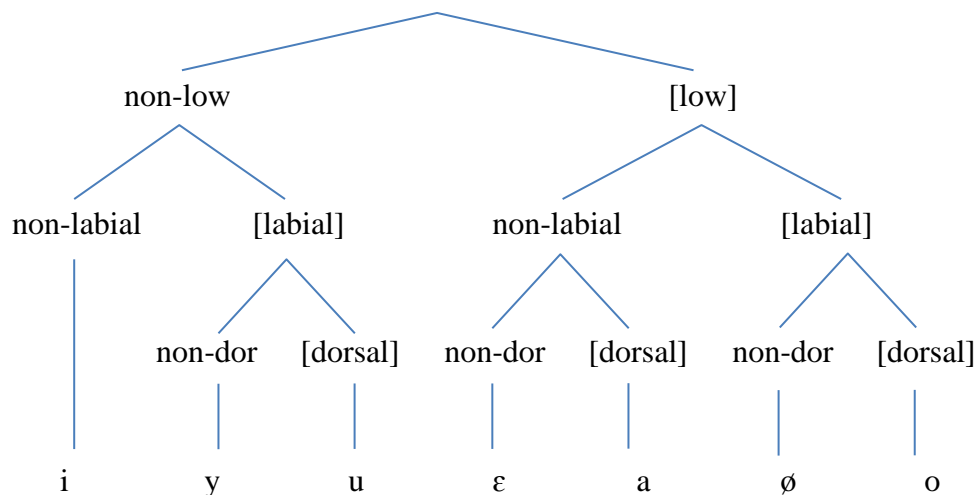

Note that all Turkic languages are typically analyzed with three contrastive features, one height feature and two place features. This is in contrast with the typical four-feature hierarchies in Mongolic, Tungusic, and (Middle) Korean. What makes this difference between Turkic vs. non-Turkic feature hierarchies is the existence vs. absence of contrastive [coronal]. Here I propose that this is the key to understand the asymmetry in vowel inventory (i.e., sparseness of low front vowels) of non-Turkic Altaic languages.

Recall that following Calabrese (2005, pp. 312–3) (cf. Jacobs and van de Weijer 1992), I assumed in §1.4.5 that front vowels may involve two different articulatory nodes, namely [coronal] and [dorsal]. All front vowels are articulated by the Tongue Body fronting, thus involving the configuration [-dorsal] (more precisely, [Dorsal, -back]). However, not all front vowels but typically high front vowels are articulated with the involvement of an additional articulator Tongue Blade, thus the feature [+coronal] (more precisely, [-anterior, +distributed] in Calabrese’s model). Then, the two types of palatalization, velar fronting and coronalization, are naturally

distinguished: velar fronting is understood as spreading of dorsal features, whereas coronalization as spreading of coronal features.

The typical palatalization found in Turkic languages is velar fronting, which supports that Turkic languages employ [dorsal]. This is illustrated with the Turkish examples below:

(16) Velar fronting in Turkish

Palatals	Velars
a. [c]	[k]
cir ‘dirt’	kir ‘countryside’
cyl ‘ash’	kul ‘slave’
cel ‘ringworm’	kal ‘speech; talk’
cør ‘blind’	kor ‘red-hot cinder, ember’
b. [ɟ]	[g]
ɟife ‘guichet; ticket-window’	giɟa ‘membrane; veil’
ɟyl ‘rose’	gul ‘ghoul; ogre’
ɟez ‘backsight’	gaz ‘gas’
ɟøl ‘lake’	gol ‘goal’

There is no clear evidence that Turkic languages employ [coronal], however.

In previous chapters, following Archangeli & Pulleyblank (1994), we have discussed that certain feature combinations may be sympathetic whereas some others may be antagonistic. For example, [+high] implies [+ATR], not [-ATR], and [+low] implies [-ATR], not [+ATR]. This correlation reflects the physical connection between the tongue body and the tongue root movement.

Similarly, we may find a negative correlation between [coronal] and [low] which is physically grounded. The contraction of the intrinsic longitudinal muscles of the tongue required for the feature [coronal] may be negatively affected by the jaw dropping required by the feature [low]. This antagonistic relationship can be represented as a constraint \*[+coronal, +low]. Then, it follows that, in Mongolic, Tungusic, Mongolic, and (Middle) Korean where [coronal] is contrastive, low front vowels are dispreferred because their existence requires the antagonistic feature combination [+coronal, +low].

On the contrary, no Turkic language employs a contrastive [coronal] feature. Instead, [dorsal] is contrastive. The feature [dorsal], by assumption, has no antagonistic relationship with [low]. Therefore, non-high front vowels (both unrounded and rounded) normally exist in the vowel inventory.

This line of reasoning may be useful to explain the harmonic class change triggered by vowel umlaut in Kalmyk (Svantesson et al., 2005, pp. 212-4). Note that, unlike \*[+high, +low], [+coronal, +dorsal] is logically not impossible since they involve different articulators, namely tongue tip and tongue body, respectively (by contrast, [high] and [low] involves the same articulator). In my analysis of Kalmyk and Oirat in §2.2.4 (recall that Kalmyk has a palatal system), I employed both [coronal] and [dorsal]. Normally, this causes no problem because [+coronal] is the only contrastive feature specification for /i/ and [±dorsal] is redundant for /i/. All other vowels are specified with [-coronal]. However, we do have cases like “umlauted *a*.” This is originally a back vowel with [+dorsal] specification which originally takes a back vowel suffix. However, “umlauted *a*” which receives [+coronal] from the conditioning /i/ may change their harmonic class and take a non-back vowel suffix. This can be explained in terms of an overriding effect: since [coronal] outranks [dorsal] in the contrastive hierarchy of Kalmyk and Oirat (7)d, when they conflict with



each other (\*[+cor, +dor], a constraint against the antagonistic combination of these two features), [+coronal] overrides [+dorsal], meaning that the vowel loses [+dorsal]. Then, it follows that it takes a [-dorsal] suffix as default.

### **6.3. Towards a theory of contrastive hierarchy changes**

In Chapter 1, I proposed a model of contrastive hierarchy changes that includes the following four types of change:

- (17) Types of contrastive hierarchy changes
  - a. Promotion and demotion
  - b. Emergence and submergence
  - c. Fusion and fission
  - d. Reanalysis

Most of these modeled changes have been illustrated with attested cases in previous chapters. Promotion/demotion was exemplified by the promotion of [low] in the development from Old Mongolian to modern Mongolic varieties (except for the Dagur type languages), as presented in Chapter 2. Emergence/submergence is widely attested in the Korean language presented in Chapter 3: for example, Middle Korean loss of [RTR], NW Korean loss of [labial], and SE Korean loss of [high] all instantiate the submergence of a contrastive feature. A specific case of emergence of a contrastive feature was not found in the history of vocalism of the languages we have seen. However, there are cases whereby a vocalic feature such as [coronal] and [RTR] is phonologized as a consonantal contrastive feature: e.g., palatalized consonants in Khalkha and other Mongolic varieties; phonemicization of uvulars in many Mongolic and Tungusic languages. Reanalysis was exemplified by the shift of harmonic feature

from [RTR] to [dorsal] in Kalmyk/Oirat. We saw one example of fission: Middle Korean [low] → EModK [low] > [high], which is associated with the change in the number of height distinction. There seems to be no attested cases of fusion. However, it seems at least conceivable that Proto-Turkic might have experienced the fusion of [coronal] and [dorsal] into [dorsal] after a reanalysis of [RTR] as [dorsal] (cf. Kalmyk/Oirat), under the assumption that Proto-Altaiic had an RTR-based system just like that of Proto-Tungusic (see (2) above), as follows:

(18) A speculative change from Proto-Altaiic to Proto-Turkic<sup>12</sup>

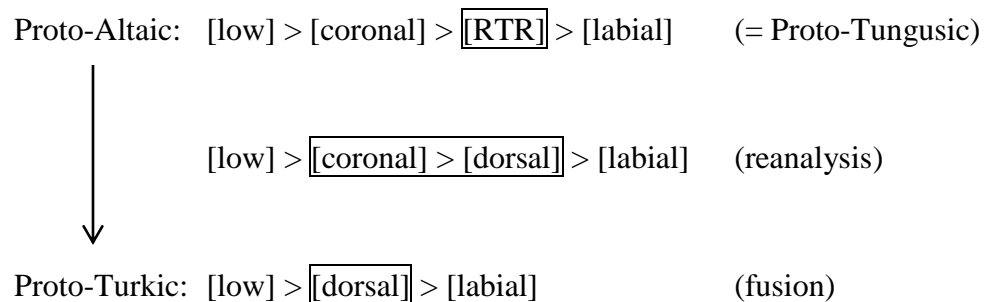

#### 6.4. Future study

There are three major directions in my future study. First, I will conduct instrumental phonetic studies of individual languages. These includes not only canonical RTR harmony languages such as Khalkha and Ewen but also “derived” or “reduced” systems such as Kalmyk/Oirat (a case of reanalysis), Dagur, Monguor, Udihe, Oroch, etc. Articulatory studies using ultrasound imaging technique and laryngoscopy will be particularly beneficial. Second, I will conduct fieldwork-based investigations and descriptions of phonological patterns in lesser-studied Altaic languages. The majority

---

<sup>12</sup> How to derive the bottom-ranked [low] in Old Mongolian from this speculative Proto-Altaiic remains unclear.

of the languages discussed in this dissertation are at the verge of extinction, but their phonological patterns (and other aspects of their grammars as well) have not been fully described in many cases, which made some of the contrastive hierarchy analyses in this dissertation only provisional. Finally, I will extend this line of research to languages in other parts of the world including African languages with tongue root harmony.

## APPENDIX

Altaic vowel inventories:

Number of vowel qualities	Vowel qualities	Language <sup>Group</sup> (reference) ( <sup>M</sup> : Mongolic, <sup>Tg</sup> : Tungusic, <sup>Tk</sup> : Turkic, <sup>K</sup> : Korean)
5	/i ə a u ɔ/	Dagur <sup>M</sup> (Chuluu, 1996; Seong et al., 2010), Literary Ewenki <sup>Tg</sup> (B. Li, 1996)
	/i e a u o/	Moghol <sup>M</sup> (Weiers, 1972), Monguor <sup>M</sup> (Svantesson et al., 2005)
	/i ə a u o/	Bonan <sup>M</sup> (Hugjiltu [Kögjiltü], 2003), Santa <sup>M</sup> (Dongxiang) (S. S. Kim, 2003), Udihe <sup>Tg</sup> (Girfanova, 2002; Nikolaeva & Tolskaya, 2001)
6	/i e a u o ɔ/	Uzbek <sup>Tk</sup> (Sjoberg, 1962)
	/i e a u ʊ ɔ/	Khamnigan <sup>M</sup> (Janhunen, 2003c; Svantesson et al., 2005)
	/i ə a u ʊ ɔ/	Written Manchu <sup>Tg</sup> (J. Kim, 1993; B. Li, 1996; X. Zhang, 1996)
	/i e ε a u ɔ/	Northwest Korean <sup>K</sup> (Kwak, 2003)
	/i ε i a u o/	Southeast Korean <sup>K</sup> (Kwak, 2003)
	/i i e a u o/	Halič Karaim <sup>Tk</sup> (Berta, 1998a)
7	/i e a u ʊ o ɔ/	Buriat <sup>M</sup> (Poppe, 1960b; Skribnik, 2003), Khalkha <sup>M</sup> (Svantesson, 1985; Svantesson et al., 2005)
	/i ə a u ʊ o ɔ/	Old Mongolian <sup>M</sup> (S. Ko, 2011b; cf. Svantesson et al., 2005 for a “palatal” analysis), (Xunke) Oroqen <sup>Tg</sup> (X. Zhang, 1996)
	/ɪ ə ʊ ʊ ɔ ɔ/	Fuyu Kirghiz <sup>Tk</sup> (C. Hu & Imart, 1987)
	/i ε ə a u ʊ ɔ/	Oroch <sup>Tg</sup> (Avrorin & Boldyrev, 2001; Avrorin & Lebedeva, 1978)
	/i ε y ə a u ɔ/	Spoken Manchu <sup>Tg</sup> (cf. J. Kim, Ko, et al., 2008 for a 5-vowel system; B. Li, 1996; X. Zhang, 1996)
	/i e y ø a u o/	Khalaj <sup>Tk</sup> (Doerfer & Muqaddam, 1971)
	/i i ʌ ə a u o/	Middle Korean <sup>K</sup> (K.-M. Lee, 1972a)
8	/i e ε i ə a u o/	Early Middle Korean <sup>K</sup> (K.-M. Lee, 1972a)
	/i e ε y ø a u o/	Kalmyk/Oirat <sup>M</sup> (Birtalan, 2003; Bläsing, 2003; Svantesson et al., 2005)
	/i ε y ø i a u o/	(Caucasian) Urum <sup>Tk</sup> (Verhoeven, 2011), (Middle) Chulym <sup>Tk</sup> (Y.-S. Li et al., 2008), Altai <sup>Tk</sup> (Schönig, 1998a), Chuvash <sup>Tk</sup> (Krueger, 1961; cf. Vovin, 1994 for a 9-vowel system with reduced /ə ɔ/), Crimean Tatar <sup>Tk</sup> (Berta, 1998a; Kavitskaya, 2010), Dolgan <sup>Tk</sup> (Y.-S. Li, 2011), Gagauz <sup>Tk</sup> (Menz, 2011), Karachai-Balkar <sup>Tk</sup> (Berta, 1998a; Hebert, 1962), Karaim <sup>Tk</sup> (Berta, 1998a), Kirghiz <sup>Tk</sup> (Comrie, 1981; Hebert & Poppe, 1963; Kirchner, 1998a), Kumyk <sup>Tk</sup> (Berta, 1998a), Salar <sup>Tk</sup> (Dwyer, 2007; Hahn, 1998a), Shor <sup>Tk</sup> (Schönig, 1998a), Tofa <sup>Tk</sup> (Schönig, 1998a), Turkish <sup>Tk</sup> (Csató & Johanson, 1998), Turkmen <sup>Tk</sup> (Schönig, 1998b), Tuvan <sup>Tk</sup> (G. D. S. Anderson & Harrison, 1999; Krueger, 1977; Schönig, 1998a), Yakut <sup>Tk</sup> (Krueger, 1962; Stachowski & Menz, 1998), Yellow Uyghur <sup>Tk</sup> (Hahn, 1998a)
/i ε y ə ə a u ɔ/	Sibe <sup>Tg</sup> (B. Li, 1996; X. Zhang, 1996)	

	/i i ə a u ɔ ɔ/	(Baiyinna) Oroqen <sup>Tg</sup> (B. Li, 1996), Ewen <sup>Tg</sup> (J. Kim, 1993; B. Li, 1996; Novikova, 1960), Negidal <sup>Tg</sup> (Kazama, 2003), Solon <sup>Tg</sup> (Z. Hu & Chaoke, 1986)
	/i i ε ə a u ɔ ɔ/	Ulchi <sup>Tg</sup> (Sunik, 1985)
9	/i e ε y ø i a u o/	Azari <sup>Tk</sup> (Dehghani, 2000), Azerbaijani <sup>Tk</sup> (Comrie, 1981; Schönig, 1998c), Bashkir <sup>Tk</sup> (Berta, 1998b; Poppe, 1964), Karakalpak <sup>Tk</sup> (Kirchner, 1998b), Kazakh <sup>Tk</sup> (Kirchner, 1998b; cf. Vajda, 1994 for an RTR-based 8-vowel system, i.e., /i ə jɪ a u ɔ wɔ wo/), Noghay <sup>Tk</sup> (Csató & Karakoç, 1998), Old Turkic <sup>Tk</sup> (Erdal, 1998), Tatar <sup>Tk</sup> (cf. Comrie, 1997a for a 10-vowel system with additional /ə/; Harrison & Kaun, 2003; Poppe, 1968), Uyghur <sup>Tk</sup> (cf. Comrie, 1997b; Hahn, 1991, 1998b; Vaux, 2000 for a 8-vowel system without /i/)
	/i e ʊ ə a u ɔ ɔ/	Kangjia <sup>M</sup> (Svantesson et al., 2005)
	/i i e y ø i a u o/	Khakas <sup>Tk</sup> (G. D. S. Anderson, 1998)
10	/i e ε y ø i ə a u o/	Central Korean <sup>K</sup> (Kwak, 2003), Northeast Korean <sup>K</sup> (Kwak, 2003), Southwest Korean <sup>K</sup> (Kwak, 2003)
	/i e y ø ə a u ɔ ɔ/	Shira Yugur <sup>M</sup> (Svantesson et al., 2005)
	/i i e ε ə a u ɔ ɔ/	Uilta <sup>Tg</sup> (Ikegami, 1955)
11	/i e y γ ə ə a u ɔ ɔ/	Baarin <sup>M</sup> (Sun et al., 1990; Svantesson et al., 2005)
12	/i e ε y ø ə i ə a u o ʌ/	Jeju Korean <sup>K</sup> (S.-C. Jeong, 1988, 1995)
14	/i i e ε y γ ø ə ə a u ɔ ɔ/	Chakhar <sup>M</sup> (Daobu [Dobo], 1983; Svantesson et al., 2005)

## BIBLIOGRAPHY

- Ahn, S.-C. (1985). *The interplay of phonology and morphology in Korean* (Ph.D. dissertation). University of Illinois at Urbana-Champaign, Urbana, IL.
- Ahn, S.-C. (2002). A dispersion account on Middle Korean vowel shifts. In N. M. Akatsuka & S. Strauss (Eds.), *Japanese/Korean Linguistics* (Vol. 10, pp. 237–250). Stanford, CA: CSLI Publications.
- Ahn, S.-C., & Iverson, G. K. (2007). Structured imbalances in the emergence of the Korean vowel system. In J. C. Salmons & S. Dubenion-Smith (Eds.), *Historical linguistics 2005: selected papers from the 17th International Conference on Historical Linguistics, Madison, Wisconsin, 31 July-5 August 2005*, Current issues in linguistic theory (pp. 275–293). John Benjamins Publishing Company.
- An, J. (1986). *Hezhe yu jianzhi [A grammatical sketch of the Hezhe language]*. Beijing: Minzu Chubanshe.
- Anderson, G. D. S. (1998). *Xakas*. Languages of the world: Materials (Vol. 251). München; Newcastle: LINCOM Europa.
- Anderson, G. D. S., & Harrison, K. D. (1999). *Tyvan*. Languages of the world: Materials (Vol. 257). München; Newcastle: LINCOM Europa.
- Anderson, S. R. (1980). Problems and perspectives in the description of vowel harmony. In R. M. Vago (Ed.), *Issues in vowel harmony: proceedings of the CUNY Linguistics Conference on Vowel Harmony, 14th May 1977*, Studies in Language Companion Series (SLCS) (pp. 1–48). Amsterdam: John Benjamins.
- Aralova, N., & Grawunder, S. (2011). *Does Even have ATR?* Presented at the CUNY Conference on the Phonology of Endangered Languages, CUNY Graduate Center. Retrieved from <http://www.cunyphonologyforum.net/endan.php>

- Aralova, N., Grawunder, S., & Winter, B. (2011). The acoustic correlates of tongue root vowel harmony in Even (Tungusic). *Proceedings of the 17th International Congress of Phonetic Sciences (ICPhS XVII)* (pp. 240–243). Presented at the The 17th International Congress of Phonetic Sciences (ICPhS XVII), Hong Kong, China. Retrieved from [http://www.icphs2011.hk/ICPHS\\_CongressProceedings.htm](http://www.icphs2011.hk/ICPHS_CongressProceedings.htm)
- Archangeli, D. B. (1984). *Underspecification in Yawelmani phonology and morphology* (Ph.D. dissertation). Massachusetts Institute of Technology, Cambridge, MA.
- Archangeli, D. B., & Pulleyblank, D. G. (1994). *Grounded phonology*. MIT Press.
- Archangeli, D. B., & Pulleyblank, D. G. (2007). Harmony. In P. V. D. Lacy (Ed.), *The Cambridge handbook of phonology* (pp. 353–378). Cambridge University Press.
- Ard, J. (1984). Vowel harmony in Manchu: a critical overview. *Journal of Linguistics*, 20(01), 57–80. doi:10.1017/S0022226700009853
- Avery, P., Dresher, B. E., & Rice, K. (2008). Introduction. In P. Avery, B. E. Dresher, & K. Rice (Eds.), *Contrast in phonology: theory, perception, acquisition* (pp. 1–8). Berlin, Germany: Mouton de Gruyter.
- Avrorin, V. A. (1958). Singarmonizm glasnykh v nanajkom jazyke. *Doklady i soobshshenija In-ta jazykoznanija AN SSSR*, 11, 137–150.
- Avrorin, V. A. (1959). *Grammatika nanajskogo jazyka [A grammar of Nanaj]* (Vol. 1). Moscow; Leningrad: Izdatel'stvo Akademii nauk SSSR.
- Avrorin, V. A. (1960). O klassifikacii tunguso-man'chzhurskix jazykov [On the classification of the Tungus-Manchu languages]. In B. Gafurov (Ed.), *Trudy XXV Mezhdunarodnogo kongressa vostokovedov* (Vol. 3). Moscow: Vostocnaja Literatura.

- Avrorin, V. A., & Boldyrev, B. V. (2001). *Grammatika orochskogo jazyka*.  
Novosibirsk: Izd. SO RAN.
- Avrorin, V. A., & Lebedeva, E. P. (1978). *Orochskiye teksty i slovar'*. Leningrad:  
Nauka.
- Bayarmend, B. (2006). Acoustic analysis of the Buriat short vowels. *Altai Hakpo*  
(*Journal of the Altaic Society of Korea*), 16, 105–116.
- Benzing, J. (1956). *Die tungusischen Sprachen: Versuch einer vergleichenden*  
*Grammatik*. Wiesbaden, Germany: Franz Steiner Verlag.
- Berta, A. (1998a). West Kipchak languages. In E. A. Csató & L. Johanson (Eds.), *The*  
*Turkic languages*, Routledge Language Family Series (pp. 301–317). London;  
New York: Routledge.
- Berta, A. (1998b). Tatar and Bashkir. In E. A. Csató & L. Johanson (Eds.), *The Turkic*  
*languages*, Routledge Language Family Series (pp. 283–300). London; New  
York: Routledge.
- Bertagaev, T. A. (1968). Mongol'skie jazyki: vvedenie [Mongolic languages:  
introduction]. *Jazyki narodov SSSR, Vol. 5: Mongol'skie, Tunguso-*  
*Man'chzhurskie i Paleoaziatskie jazyki [The languages of the peoples of the*  
*USSR, Vol. 5: Mongolic, Manchu-Tungus, and Paleoasian languages]* (pp. 7–  
12). Leningrad: Nauka.
- Binnick, R. I. (1987). On the classification of the Mongolian languages. *Central*  
*Asiatic Journal*, 31, 178–195.
- Birtalan, Á. (2003). Oirat. In J. Janhunen (Ed.), *The Mongolic languages*, Routledge  
Language Family Series (pp. 210–228). London: Routledge.
- Bläsing, U. (2003). Kalmuck. In J. Janhunen (Ed.), *The Mongolic languages*,  
Routledge Language Family Series (pp. 229–247). London: Routledge.



- Bruening, B. (2012). *No such thing as “Defective Intervention.”* Unpublished manuscript, University of Delaware.
- Buhe [Böke]. (1983). Dongxiangyu de yuanyin hexie xianzhuang tanxi [Preliminary analysis of Santa vowel harmony]. *Minzu Yuwen*, 1983(4), 24–30.
- Buhe [Böke]. (1986). *Dongxiangyu he Mengguyu [Santa and Mongolian]*. Monggol töröl-ün kele ayalgun-u sudulul-un cuburil. Kökeqota: Ö bör Monggol-un arad-un keblel-ün qoriy-a.
- Bulatova, N., & Grenoble, L. A. (1999). *Evenki*. Languages of the world: Materials (Vol. 141). München; Newcastle: Lincom Europa.
- Bulucilagu. (1985). *Dongbu Yuguyu cihui [Shira Yugur vocabulary]*. Monggol töröl-ün kele ayalgun-u sudulul-un cuburil. Kökeqota: Ö bör Monggol-un arad-un keblel-ün qoriy-a.
- Bulucilagu, & Jalsan. (1992). *Dongbu Yuguyu he Mengguyu [Shira Yugur and Mongolian]*. Monggol töröl-ün kele ayalgun-u sudulul-un cuburil. Kökeqota: Ö bör Monggol-un arad-un keblel-ün qoriy-a.
- Buraev, I. D. (1959). *Zvukovoj sostav burjatskogo jazyka [The sound structure of Buriat]*. Ulan-Ude.
- Calabrese, A. (2000). The feature [Advanced Tongue Root] and vowel fronting in Romance. In L. Repetti (Ed.), *Phonological theory and the dialects of Italy* (pp. 59–88). John Benjamins Publishing Company.
- Calabrese, A. (2005). *Markedness and economy in a derivational model of phonology*. Studies in generative grammar. Walter de Gruyter.
- Campbell, L. (2004). *Historical linguistics: an introduction* (2nd ed.). Edinburgh University Press.



- Chen, N. (1986). *Baoan kelen-ü üges [Vocabulary of the Baoan language]*. Huhhot: Inner Mongolian People's Press.
- Chen, N. (1987). *Baoan kele ba Mongyol kele [Baoan and Mongolian languages]*. Huhhot: Inner Mongolian People's Press.
- Chen, N. (1990). bǎo ān yǔ de yǎn biàn guǐ jī [The locus of the evolution of the Baoan language]. *Minzu Yuwen*, 3/4, 16–25; 42–48.
- Cho, M.-H. (1994). *Vowel harmony in Korean: a grounded phonology approach* (Ph.D. dissertation). Indiana University, Bloomington, IN.
- Cho, T., Jun, S.-A., Jung, S.-C., & Ladefoged, P. (2000). The vowels of Cheju. *UCLA Working Papers in Phonetics*, 98, 81–94.
- Choi, J.-S. (1978). Kwuke i-umlaut hyensanguy thongsicek kochal [A diachronic research on Korean i-umlaut]. *Kwukemwunhak*, 19, 173–212.
- Choi, M.-O. (1982). *Welsengciyekeuy umwunlon [The phonology of the Welseng regional dialect]*. Yeungnam University Press.
- Chomsky, N. (2000). Minimalist inquiries: The framework. In R. A. Martin, D. Michaels, & J. Uriagereka (Eds.), *Step by step: essays on minimalist syntax in honor of Howard Lasnik* (pp. 89–155). Cambridge, MA: MIT Press.
- Chomsky, N., & Halle, M. (1968). *The sound pattern of English*. New York: Harper & Row. Retrieved from <http://www.eric.ed.gov/ERICWebPortal/detail?accno=ED020511>
- Chuluu, Ü. (1994a). *Introduction, grammar and sample sentences for Dagur*. Sino-Platonic papers. Philadelphia, PA: Department of East Asian Languages and Civilizations, University of Pennsylvania. Retrieved from [www.sino-platonic.org](http://www.sino-platonic.org)
- Chuluu, Ü. (1994b). *Introduction, grammar and sample sentences for Dongxiang*. Sino-Platonic papers. Philadelphia, PA: Department of East Asian Languages

- and Civilizations, University of Pennsylvania. Retrieved from [www.sino-platonic.org](http://www.sino-platonic.org)
- Chuluu, Ü . (1994c). *Introduction, grammar and sample sentences for Baoan*. Sino-Platonic papers. Philadelphia, PA: Department of East Asian Languages and Civilizations, University of Pennsylvania. Retrieved from [www.sino-platonic.org](http://www.sino-platonic.org)
- Chuluu, Ü . (1994d). *Introduction, grammar and sample sentences for Jegün Yogur*. Sino-Platonic papers. Philadelphia, PA: Department of East Asian Languages and Civilizations, University of Pennsylvania. Retrieved from [www.sino-platonic.org](http://www.sino-platonic.org)
- Chuluu, Ü . (1996). *Daur*. Languages of the world: materials. LINCOM Europa.
- Cincius, V. I. (1949). *Sravnitel'naja fonetika tunguso-man'chzhurskikh jazykov [The comparative phonetics of the Tungus-Manchu languages]*. Leningrad: Uchpedgiz.
- Cincius, V. I. (1982). *Negidal'skij jazyk [The Negidal language]*. Leningrad: Nauka.
- Cincius, V. I. (Ed.). (1975). *Sravnitel'nyj slovar' tunguso-man'chzhurskikh jazykov [A comparative dictionary of the Manchu-Tungusic languages]* (Vol. 1–2). Leningrad: Nauka.
- Clements, G. N. (1991). Place of articulation in consonants and vowels: a unified theory. *Working papers of the Cornell Phonetics Laboratory*, 5, 77–123.
- Clements, G. N. (2003). Feature Economy in Sound Systems. *Phonology*, 20(03), 287–333. doi:10.1017/S095267570400003X
- Clements, G. N., & Hume, E. (1995). The internal organization of speech sounds. *The handbook of phonological theory* (pp. 245–306). Oxford: Blackwell.

- Clements, G. N., & Rialland, A. (2008). Africa as a phonological area. In B. Heine & D. Nurse (Eds.), *A linguistic geography of Africa* (pp. 36–85). New York: Cambridge University Press.
- Clements, G. N., & Sezer, E. (1982). Vowel and consonant disharmony in Turkish. In H. G. van der Hulst & N. Smith (Eds.), *The structure of phonological representations (Part II)* (pp. 213–255). Dordrecht: Foris Publications.
- Colarusso, J. (1988). *The northwest Caucasian languages: a phonological survey*. New York and London: Garland.
- Cole, J., & Hualde, J. I. (2010). *Underlying representations*. Unpublished manuscript, Urbana-Champaign, IL. Retrieved from [https://netfiles.uiuc.edu/jihualde/www/Cole&Hualde\\_UnderlyingRepresentations\\_revisedsubmission.pdf](https://netfiles.uiuc.edu/jihualde/www/Cole&Hualde_UnderlyingRepresentations_revisedsubmission.pdf)
- Compton, R., & Drescher, B. E. (2011). Palatalization and “strong i” across Inuit dialects. *The Canadian Journal of Linguistics / La revue canadienne de linguistique*, 56(2).
- Comrie, B. (1981). *The languages of the Soviet Union*. Cambridge, UK: Cambridge University Press.
- Comrie, B. (1997a). Tatar (Volga Tatar, Kazan Tatar) phonology. In A. S. Kaye & P. T. Daniels (Eds.), *Phonologies of Asia and Africa: (including the Caucasus)* (Vol. 2, pp. 899–911). Winona Lake, IN: Eisenbrauns.
- Comrie, B. (1997b). Uyghur phonology. In A. S. Kaye & P. T. Daniels (Eds.), *Phonologies of Asia and Africa: (including the Caucasus)* (Vol. 2, pp. 913–925). Winona Lake, IN: Eisenbrauns.
- Crothers, J. (1978). Typology and universals of vowel systems. In J. H. Greenberg, C. A. Ferguson, & E. A. Moravcsik (Eds.), *Universals of human language* (Vol. 2: phonology, pp. 93–152). Stanford, CA: Stanford University Press.

- Csató, E. A., & Johanson, L. (1998). Turkish. In E. A. Csató & L. Johanson (Eds.), *The Turkic languages*, Routledge Language Family Series (pp. 203–235). London; New York: Routledge.
- Csató, E. A., & Karakoç, B. (1998). Noghay. In E. A. Csató & L. Johanson (Eds.), *The Turkic languages*, Routledge Language Family Series (pp. 333–343). London; New York: Routledge.
- Damdinov, D. G. (1968). Etno-lingvističeskii očerok xamniganskogo govora. *Issledovanie buryatskix govorov [Trudy Buryatskogo instituta obshhestvennyx nauk BF SO AN SSSR]* (Vol. 2, pp. 74–116). Ulan-Ude: Buryatskoe knizhnoe izdatel'stvo.
- Daobu [Dobo]. (1983). *Měnggǔyǔ jiǎnzhì [Short description of Mongolian]*. Běijīng: Mǐnzú.
- de Boer, E. M. (1996). Present state of the study of Evenki vowel harmony. *Proceedings of the 38th Permanent International Altaistic Conference (PIAC)* (pp. 121–133). Presented at the Permanent International Altaistic Conference (PIAC), Wiesbaden, Germany: Harrassowitz.
- Dehghani, Y. (2000). *A grammar of Iranian Azari: including comparisons with Persian*. LINCOM Studies in Asian Linguistics. München: LINCOM Europa.
- Doak, I. G. (1992). Another Look at Coeur d'Alene Harmony. *International Journal of American Linguistics*, 58(1), 1–35.
- Doerfer, G. (1963). Bemerkungen zur Verwandtschaft der sog. altaische Sprachen [Remarks on the relationship of the so-called Altaic languages]. In G. doerfer (Ed.), *Türkische und mongolische Elemente im Neupersischen: unter besonderer Berücksichtigung älterer neupersischer Geschichtsquellen, vor allem der Mongolen- und Timuridenzeit* (pp. 51–105). Wiesbaden: Franz Steiner Verlag.

- Doerfer, G. (1964). Klassifikation und Verbreitung der Mongolischen Sprachen. *Mongolistik (Handbuch der Orientalistik I: V, 2)* (pp. 35–50). Leiden: Brill.
- Doerfer, G. (1978). Classification problems of Tungus. In G. Doerfer & M. Weiers (Eds.), *Tungusica* (Vol. 1, pp. 1–26). Wiesbaden, Germany: Otto Harrassowitz.
- Doerfer, G., & Muqaddam, M. (1971). *Khalaj materials*. Indiana University Publications Uralic and Altaic Series. Bloomington, IN: Indiana University.
- Donohue, M. (2006). Coronals and velars: support for Blust. *Oceanic Linguistics*, 45(1), 229–241.
- Dresher, B. E. (2009). *The contrastive hierarchy in phonology*. Cambridge University Press.
- Dresher, B. E. (2011, November 11). *Contrastive features and microvariation in vowel harmony*. Paper presented at the The 42nd annual meeting of the North East Linguistic Society (NELS 42), University of Toronto. Retrieved from <http://linguistics.utoronto.ca/nels42/index.html>
- Dresher, B. E., & Zhang, X. (2005). Contrast and Phonological Activity in Manchu Vowel Systems. *The Canadian Journal of Linguistics / La revue canadienne de linguistique*, 50(1/2/3/4), 45–82.
- Dwyer, A. M. (2007). *Salar: a study in inner Asian language contact processes*. Turcologica. Wiesbaden: Harrassowitz.
- Edmondson, J. A., & Esling, J. H. (2006). The valves of the throat and their functioning in tone, vocal register and stress: laryngoscopic case studies. *Phonology*, 23(02), 157–191. doi:10.1017/S095267570600087X
- Engkebatu, M. (1984). *Dáwò 'ěryū cíhuì [Dagur and vocabulary]*. Monggol töröl-ün kele ayalgun-u sudulul-un cuburil.
- Engkebatu, M. (1988). *Dáwò 'ěryū hé Měnggūyū [Dagur and Mongolian]*. Monggol töröl-ün kele ayalgun-u sudulul-un cuburil.

- Erdal, M. (1998). Old Turkic. In E. A. Csató & L. Johanson (Eds.), *The Turkic languages*, Routledge Language Family Series (pp. 138–157). London; New York: Routledge.
- Field, K. L. (1997). *A grammatical overview of Santa Mongolian* (Ph.D.). University of California, Santa Barbara, Santa Barbara, CA. Retrieved from <http://search.proquest.com/pqdtft/docview/304358668/abstract/137CCF100B3A250BA5/1?accountid=10267>
- Finer, D. L. (1981). Concrete vowel harmony in Manchu. *Linguistic Analysis*, 7(3), 263–275.
- Fischer-Jørgensen, E. (1967). Phonetic analysis of breathy (murmured) vowels in Gujarati. *Indian Linguistics*, 28, 71–139.
- Flemming, E. S. (2002). *Auditory representations in phonology*. Routledge.
- Fortescue, M. D., Jacobson, S. A., & Kaplan, L. D. (1994). *Comparative Eskimo dictionary: with Aleut cognates*. Alaska Native Language Center, University of Alaska Fairbanks.
- Frellesvig, B., & Whitman, J. (2008). The Japanese-Korean vowel correspondences. In M. E. Hudson, S.-A. Jun, P. Sells, P. M. Clancy, S. Iwasaki, & S.-O. Sohn (Eds.), *Japanese/Korean Linguistics* (Vol. 13, pp. 15–28). Stanford, CA: CSLI Publications.
- Fried, R. W. (2010, June 1). *A grammar of Bao'an Tu, a Mongolic language of Northwest China* (Ph.D.). University of Buffalo, State University of New York, Buffalo, NY.
- Fulop, S. A., Kari, E., & Ladefoged, P. (1998). An acoustic study of the tongue root contrast in Degema vowels. *Phonetica*, 55(1-2), 80–98.  
doi:10.1159/000028425



- Gamkrelidze, T. V. (1978). On the correlation of stops and fricatives in a phonological system. In J. H. Greenberg, C. A. Ferguson, & E. A. Moravcsik (Eds.), *Universals of human language* (Vol. 2: phonology, pp. 9–46). Stanford, CA: Stanford University Press.
- Georg, S. (2003). Mongghul. In J. Janhunen (Ed.), *The Mongolic languages*, Routledge Language Family Series (pp. 286–306). London: Routledge.
- Georg, S., Michalove, P. A., Ramer, A. M., & Sidwell, P. J. (1999). Telling General Linguists About Altaic. *Journal of Linguistics*, 35(01), 65–98. doi:null
- Ghini, M. (2001). Place of articulation first. In T. A. Hall (Ed.), *Distinctive feature theory* (pp. 147–176). Walter de Gruyter.
- Girfanova, A. H. (2002). *Udeghe*. Languages of the world: Materials (Vol. 255). München; Newcastle: Lincom Europa.
- Gordon, M., & Ladefoged, P. (2001). Phonation types: a cross-linguistic overview. *Journal of Phonetics*, 29(4), 383–406. doi:10.1006/jpho.2001.0147
- Gouskova, M. (2004). Relational hierarchies in Optimality Theory: the case of syllable contact. *Phonology*, 21(2), 201–250.
- Gregerson, K. J. (1976). Tongue-root and register in Mon-Khmer. *Oceanic Linguistics Special Publications*, (13), 323–369.
- Guion, S. G., Post, M. W., & Payne, D. L. (2004). Phonetic correlates of tongue root vowel contrasts in Maa. *Journal of Phonetics*, 32(4), 517–542. doi:10.1016/j.wocn.2004.04.002
- Hahn, R. F. (1991). Diachronic aspects of regular disharmony in modern Uyghur. In W. G. Boltz & M. C. Shapiro (Eds.), *Studies in the historical phonology of Asian languages* (pp. 68–101). Amsterdam: John Benjamins Publishing Company.

- Hahn, R. F. (1998a). Yellow Uyghur and Salar. In E. A. Csató & L. Johanson (Eds.), *The Turkic languages*, Routledge Language Family Series (pp. 397–402). London; New York: Routledge.
- Hahn, R. F. (1998b). Uyghur. In E. A. Csató & L. Johanson (Eds.), *The Turkic languages*, Routledge Language Family Series (pp. 379–396). London; New York: Routledge.
- Hall, B. L., & Hall, R. M. R. (1980). Nez Perce vowel harmony: an Africanist explanation and some theoretical questions. In Robert Michael Vago (Ed.), *Issues in vowel harmony: proceedings of the CUNY Linguistics Conference on Vowel Harmony, 14th May 1977*, Studies in Language Companion Series (SLCS). John Benjamins Publishing Company.
- Hall, B. L., Hall, R. M. R., Pam, M. D., Myers, A., Antell, S. A., & Cheronon, G. K. (1974). African vowel harmony systems from the vantage point of Kalenjin. *Afrika und Ü bersee*, 57, 241–267.
- Hall, D. C. (2007). *The role and representation of contrast in phonological theory* (Ph.D. dissertation). University of Toronto. Retrieved from <https://jps.library.utoronto.ca/index.php/twpl/article/view/6497>
- Hall, T. A. (1997). *The phonology of coronals*. Current issues in linguistic theory (Vol. 149). Amsterdam: John Benjamins Publishing Company.
- Hall, T. A. (2000). Typological generalizations concerning secondary palatalization. *Lingua*, 110(1), 1–25. doi:10.1016/S0024-3841(99)00017-0
- Halle, M. (1995). Feature geometry and feature spreading. *Linguistic Inquiry*, 26(1), 1–46.
- Halle, M., & Stevens, K. N. (1969). *On the feature “Advanced Tongue Root”* ( No. 94). MIT Research Laboratory of Electronics Quarterly Progress Report (pp. 209–215). Cambridge, MA: MIT.

- Halle, M., Vaux, B., & Wolfe, A. (2000). On feature spreading and the representation of place of articulation. *Linguistic Inquiry*, 31(3), 387–444.  
doi:10.1162/002438900554398
- Han, Y.-K. (1990). Moumcohwaury pwungkoywa “alay a”-uy iltankyey pyenhwa [The collapse of vowel harmony and the first-step change of “alay a”]. *Kwukehak*, 20, 113–136.
- Harrison, D. K., & Kaun, A. R. (2003). Vowels and vowel harmony in Namagan Tatar. In D. A. Holisky & K. Tuite (Eds.), *Current trends in Caucasian, East European, and inner Asian linguistics : papers in honor of Howard I. Aronson*, Amsterdam studies in the theory and history of linguistic science (Vol. 246, pp. 193–206). Amsterdam/Philadelphia: John Benjamins Publishing Company.
- Hasbagana. (2003). The schwa in Mongolian: Mongolian vowel reduction in non-initial syllables. *Mongolian Studies*, 26, 1–9.
- Hattori, S. (1973). The Chinese dialect on which the transcription of the Yüan-ch‘ao Mi-Shih was based. *Acta Asiatica (Bulletin of the Institute of Eastern Culture)* (Vol. 24, pp. 35–44). Tokyo, Japan: Toho Gakkai [The Institute of Eastern Culture].
- Hattori S. (1975). Boin chowa to chuki chosengo no boin taikai [Vowel harmony and the Middle Korean vowel system]. *Gengo no Kagaku*, 6, 1–22.
- Hattori, S. (1978). Remarks on the sounds of Middle Korean of the late fifteenth century. *Proceedings of the 6th International Symposium*. Presented at the The 6th International Symposium, Seoul, Korea: National Academy of Sciences.
- Hattori, S. (1982). Vowel harmonies of the Altaic languages, Korean, and Japanese. *Acta Orientalia Hungarica*, 36, 207–14.
- Hayata, T. (1975). A note on vowel harmony in Middle Korean. *Gengo Kenkyu (Journal of the Linguistic Society of Japan)*, 68, 104–118.

- Hayata, T. (1979). Orok noun morphophonology. *Asian and African Linguistics*, 8, 129–164.
- Hayata, T. (1980). Non-Abstract Vowel Harmony in Manchu. *Gengo Kenkyu (Journal of the Linguistic Society of Japan)*, 77, 59–79.
- Hebert, R. J. (1962). Karačay phonology. In N. N. Poppe (Ed.), *American studies in Altaic linguistics*, Indiana University Publications Uralic and Altaic Series (pp. 97–113). Bloomington, IN: Indiana University Press.
- Hebert, R. J., & Poppe, N. N. (1963). *Kirghiz Manual*. Uralic and Altaic Series. Taylor and Francis.
- Hess, S. (1992). Assimilatory effects in a vowel harmony system: an acoustic analysis of advanced tongue root in Akan. *Journal of Phonetics*, 20, 475–492.
- Hirayama, H. (1967). *Chūko kango no onin [The phonology of Middle Chinese]*. Chūgoku bunka sōsho. Tokyo: Taishūkan Shoten.
- Hu, C., & Imart, G. (1987). *Fu-yü Gīrgīs: a tentative description of the easternmost Turkic language*. Bloomington, IN: Indiana University Research Institute for Inner Asian Studies.
- Hu, Z., & Chaoke, D. O. (1986). *Ewenke yu jianzhi [A grammatical sketch of Ewenki]*. Beijing: Minzu Chubanshe.
- Hudu, F. A. (2010). *Dagbani tongue-root harmony: a formal account with ultrasound investigation* (Ph.D. dissertation). University of British Columbia, Vancouver, Canada. Retrieved from <https://circle.ubc.ca/handle/2429/27777>
- Hudu, F. A., Miller, A., & Pulleyblank, D. (2009). Ultrasound imaging and theories of tongue root phenomena in African languages. In P. K. Austin, O. Bond, M. Charette, D. Nathan, & P. Sells (Eds.), *Proceedings of Conference on Language Documentation and Linguistic Theory 2* (pp. 153–163). Presented at

- the Conference on Language Documentation and Linguistic Theory 2, London: SOAS. Retrieved from [www.hrhelp.org/eprints/ldlt2\\_16.pdf](http://www.hrhelp.org/eprints/ldlt2_16.pdf)
- Huffman, M. K. (1987). Measures of phonation type in Hmong. *The Journal of the Acoustical Society of America*, 81(2), 495–504.
- Hugjiltu [Kögjiltü], W. (2003). Bonan. In J. Janhunen (Ed.), *The Mongolic languages*, Routledge Language Family Series (pp. 325–345). London: Routledge.
- Huh, W. (1965). *Kwuke umwunhak [Korean phonology]*. Seoul, Korea: Cengumsa.
- Huh, W. (1980). *Kwuke umwunhak [Korean phonology]*. Seoul, Korea: Saym Mwunhwas.
- Hyeon, P.-H. (1962). *Ceycwuto pangen yenkwu nonkophyen [A study of Cheju dialect]*. Seoul, Korea: Cengyensa.
- Hyeon, P.-H. (1964). Ceycwudo pang.enuy tanmoum selceng [A construction of the monophthongs of Cheju-do dialect]. *Hankwuk Ene Mwunhak [Korea Language and Literature]*, 2, 43–52.
- Hyman, L. M. (1970). How concrete is phonology? *Language*, 46(1), 58–76.  
doi:10.2307/412407
- Hyman, L. M. (1976). Phonologization. In A. G. Juillard (Ed.), *Linguistic studies offered to Joseph Greenberg on the occasion of his sixtieth birthday*, *Studia linguistica et philologica* (Vols. 1-3, Vol. 2: Phonology). Saratoga, CA: Anma Libri & Co.
- Hyun, W.-J. (1992). *Ceycwu pangen holsoliuy silhem umsenghakcek yenkwu [An experimental phonetic study of the vowels of Cheju dialect]* (Ph.D. dissertation). Konkuk University, Seoul, Korea.
- Ikegami J. (1955). Tunguusugo [The Tungus language]. In Ichikawa S. & Hattori S. (Eds.), *Sekai gengo gaisetsu [An introduction to world languages]* (Vol. 2, pp. 441–488). Tokyo: Kenkyusha Jishobu.

- Ikegami, J. (1956). The substantive inflection of Orok. *Gengo Kenkyu (Journal of the Linguistic Society of Japan)*, 30, 77–96.
- Ikegami, J. (1959). The verb inflection of Orok. *Kokugo Kenkyu*, 9, 34–73.
- Ikegami J. (1997). *Uirutago jiten [A dictionary of the Uilta language spoken on Sakhalin]*. Sapporo: Hokkaido University Press.
- Ikegami, J. (2001). The verb inflection of Orok. *Researches on the Tungus language* (pp. 24–72). Tokyo: Kyuko Shoin.
- Indjieva, E. (2009). *Oirat Tobi: intonational structure of the Oirat language* (Ph.D. dissertation). University of Hawai‘i.
- Ito, C. (2007). *Chōsen kanzion kenkyū [Sino-Korean phonology]*. Tokyo: Kyukoshoin.
- Jacobson, L. C. (1978). DhoLuo vowel harmony: a phonetic investigation. *UCLA Working Papers in Phonetics*, 43.
- Jacobson, L. C. (1980). Voice-quality harmony in Western Nilotic languages. In Robert Michael Vago (Ed.), *Issues in vowel harmony: proceedings of the CUNY Linguistics Conference on Vowel Harmony, 14th May 1977*, Studies in Language Companion Series (SLCS) (pp. 183–200). Amsterdam: John Benjamins.
- Jakobson, R., Fant, G., & Halle, M. (1952). *Preliminaries to speech analysis: the distinctive features and their correlates*. Cambridge, MA: MIT Press.
- Jakobson, R., & Halle, M. (1956). *Fundamentals of language*. Copenhagen: Mouton.
- Janhunen, J. (1998). Ethnicity and language in prehistoric Northeast Asia. In R. Blench & M. Spriggs (Eds.), *Archaeology and language II* (pp. 195–208). London: Routledge.

- Janhunen, J. (2003a). Proto-Mongolic. In J. Janhunen (Ed.), *The Mongolic languages*, Routledge Language Family Series (pp. 1–29). London: Routledge.
- Janhunen, J. (2003b). Mongol dialects. In J. Janhunen (Ed.), *The Mongolic languages*, Routledge Language Family Series (pp. 177–192). London: Routledge.
- Janhunen, J. (2003c). Khamnigan Mongol. In J. Janhunen (Ed.), *The Mongolic languages*, Routledge Language Family Series (pp. 83–101). London: Routledge.
- Janhunen, J. (2003d). Written Mongol. In J. Janhunen (Ed.), *The Mongolic languages*, Routledge Language Family Series (pp. 30–52). London: Routledge.
- Janhunen, J. (2005). *Khamnigan Mongol*. Muenchen: Lincom Europa.
- Janhunen, J. (Ed.). (2003e). *The Mongolic languages*. Routledge Language Family Series. London: Routledge.
- Janhunen, J., & Salminen, T. (1993, 2000). UNESCO Red Book on Endangered Languages: Northeast Asia. *UNESCO Red Book on Endangered Languages: Northeast Asia*. Retrieved January 30, 2012, from [http://www.helsinki.fi/~tasalmin/nasia\\_index.html](http://www.helsinki.fi/~tasalmin/nasia_index.html)
- Jeong, S.-C. (1988). *Ceycwuto pangenuy moumcheykyeywa kuey kwanlyentoyun umwunhyensang [The vowel system of Cheju dialect]* (Master thesis). Seoul National University, Seoul, Korea.
- Jeong, S.-C. (1995). *Ceycwuto pangenuy thongsiumwunlon [A diachronic approach to the phonological processes of Cheju dialect]*. Kwukehak Chongse. Seoul, Korea: Thaehaksa.
- Jeong, S.-H. (2009). Hwunmincengumkwa ilpone phyoki [Hunminjengeum transcriptions of Japanese]. *Proceedings of the SCRIPTA 2009*. Presented at the SCRIPTA 2009. Retrieved from [http://www.scripta.kr/scripta2010/en/proceedings/proc09v01\\_003.pdf](http://www.scripta.kr/scripta2010/en/proceedings/proc09v01_003.pdf)

- Ji, J. (1976). *15seyki kwukeuy moumcheykyey swucenglon [A revised theory of the vowel system in the 15th century Korean]*. Hyengsel chwulphansa.
- Johnson, R. (1975). *The role of phonetic detail in Coeur d'Alene phonology* (Ph.D. dissertation). Washington State University.
- Joseph, A., & Whitman, J. (2012). The diachronic consequences of the RTR analysis of Tungusic vowel harmony. Presented at the The 8th Workshop on Altaic Formal Linguistics (WAFL 8), University of Stuttgart.
- Junast. (1981). *Dongbu Yuguyu jianzhi [Short description of Shira Yugur]*. Zhongguo Shaoshu Minzu Yuyan Jianzhi Congshu. Beijing: Minzu Chubanshe.
- Kager, R. (1999). *Optimality Theory*. Cambridge University Press.
- Kang, H., & Ko, S. (2012). In search of the acoustic correlates of tongue root contrast in three Altaic languages: Western Buriat, Tsongol Buriat, and Ewen. *Altai Hakpo (Journal of the Altaic Society of Korea)*, 22.
- Kang, S. (1980). *Kyeylim yusa Kolye pangen yenkwu [A study of Koryeo dialect in the Jilin lèishì]*. Seoul, Korea: Sungkyunkwan University Press.
- Kang, S. (1997). The vowel system of the Korean alphabet and Korean readings of Chinese characters. In Y.-K. Kim-Renaud (Ed.), *The Korean alphabet: its history and structure* (pp. 117–129). Honolulu: University of Hawai'i Press.
- Kara, G. (2005). *Books of the Mongolian nomads: more than eight centuries of writing Mongolian*. Bloomington, IN: Indiana University Research Institute for Inner Asian Studies.
- Kara, G. (2006). Review of *The Mongolic Languages* (Edited by Juha Janhunen). *Anthropological Linguistics*, 48(1), 99–106.
- Kaun, A. R. (1995). *The typology of rounding harmony: an Optimality Theoretic approach* (Ph.D. dissertation). University of California, Los Angeles.



- Kaun, A. R. (2004). The typology of rounding harmony. *Phonetically based phonology* (pp. 87–116). Cambridge, UK: Cambridge University Press.
- Kavitskaya, D. (2010). *Crimean Tatar*. Languages of the World/Materials. München: Lincom Europa.
- Kazama, S. (2003). *Basic vocabulary (A) of Tungusic languages*. Endangered Languages of the Pacific Rim. Kyoto: ELPR.
- Kenstowicz, M. J. (1979). Chukchee vowel harmony and epenthesis. In P. R. Clyne, W. F. Hanks, & C. Hofbauer (Eds.), *The elements: a parasession on linguistic units and levels (Including papers from the Conference on Non-Slavic Languages of the USSR)* (pp. 402–412). Presented at the The 15th regional meeting of the Chicago Linguistic Society (CLS 15), Chicago, IL: Chicago Linguistic Society, University of Chicago.
- Kenstowicz, M. J. (1994). *Phonology in generative grammar*. Blackwell.
- Kenstowicz, M. J., & Kisseberth, C. W. (1979). *Generative phonology: description and theory*. New York, NY: Academic Press.
- Kim, C.-G. (1984). 15seyki kwukeuy tanmoum cheykyey [Monophthong system of the 15th century Korean]. *Saykyel pakthaykwen sensayng hoykapkinyemnonchong*.
- Kim, C.-G. (1985). Hwunmincengum haylyeyuy moumcheykyey [Vowel system of Hunminjeongeum Haerye]. *Senotang kimhyengki sensayng phalcilkinyem kwukehak nonchong*.
- Kim, C.-G. (1995). Hye okulimkwa wulimal holsoli ewullimuy eceywa onul [Tongue contraction and the past and present of vowel harmony in Korean]. *Hangeul*, 229, 21–79.
- Kim, C.-W. (1978). “Diagonal” vowel harmony?: Some implications for historical phonology. In J. Fisiak (Ed.), *Recent Developments in Historical Phonology*

- (1978th ed., Vol. 4, pp. 221–236). Berlin; New York: Mouton de Gruyter.  
Retrieved from <http://www.reference-global.com/doi/abs/10.1515/9783110810929.221>
- Kim, H.-K. (1980). An acoustic study of the Cheju dialect in Korean. *Eon-Eo (Journal of the Linguistic Society of Korea)*, 5(1), 25–61.
- Kim, J. (1988a). Moumcohwawa selchwuk: Hwunminjengum haylyeyuy selchwukey tayhaye [Vowel harmony and “selchwuk”: On the tongue retraction in Hunminjeongeum]. *Eoneohag (Journal of the Linguistic Society of Korea)*, 9/10.
- Kim, J. (1988b). Nanaieuy moumcohwa [Vowel harmony in Nanai]. *Kwukehak*, 17, 229–246.
- Kim, J. (1989). *Mancwu thwungkwusuceyeuy moumcohwa yenkwu [A study on vowel harmony in the Manchu-Tungus languages]* (Ph.D. dissertation). Seoul National University.
- Kim, J. (1993). *Moumcohwaury yenku [A study on vowel harmony in Korean]*. Kyeungsan, Korea: Yeungnam University Press.
- Kim, J. (1996). Mancwuthwungkwusuceyeuy censelmoumuy paltaley tayhaye (On the development of front vowels in Manchu-Tungus languages). *Altai Hakpo (Journal of the Altaic Society of Korea)*, 6, 25–35.
- Kim, J. (1999). Selkunhwuchwukkwa selkuncencin [RTR and ATR]. *Eneuy yeksa [History of languages: in honor of Professor Baeg-in Seong]* (pp. 311–341). Seoul, Korea: Thaehaksa.
- Kim, J. (2000). Kwukeuy pangen pwunhwawa paltal [Bifurcation and development of Korean dialects]. *Hankwukmwunhwasangtaykyey* (Vol. 1, pp. 151–185). Daegu, Korea: Mincokmwunhwayenkwuso, Yeungnam University.

- Kim, J. (2001). RTR vowel harmony in Korean and Altaic languages. *Journal of Korean Studies (Journal of the Central Asian Association for Korean Studies)*, 1, 71–92.
- Kim, J. (2011). *A grammar of Ewen*. Altaic Languages Series. Seoul National University Press.
- Kim, J., Ko, D., Chaoke, D. O., Han, Y., Piao, L., & Boldyrev, B. V. (2008). *Materials of spoken Manchu*. Altaic languages series. Seoul National University Press.
- Kim, J., Kwon, J.-I., Ko, D., Kim, Y.-S., & Jeon, S. (2008). *Salacye kanun althaienelul chacase [Documentation of endangered Altaic languages]* (second.). Phacwu, Korea: Thaeaksa.
- Kim, J., Yu, W., Li, Y.-S., Choi, M.-J., Choi, W., Lee, H., Jeon, S., et al. (2011). *Ene tayangseng poconul wihan altai ene mwunsehwa [Documentation of Altaic languages for the maintenance of language diversity]* (second.). Phacwu, Korea: Thaeaksa.
- Kim, J.-K. (2000). *Quantity-sensitivity and feature-sensitivity of vowels: a constraint-based approach to Korean vowel phonology* (Ph.D. dissertation). Indiana University.
- Kim, J.-P. (2001). “뽕”-uy [swunumseng] kwanlyen hyensangkwa fi-louy yakhwa [The [+labial] feature of β and its change to fi in Late Middle Korean]. *Kwukehak*, 38, 27–54.
- Kim, J.-P. (2003). Hwuki cwungseykwukeuy umwunhyensangkwa moumcheykyey [Phonological phenomena and vowel system of the Late Middle Korean]. *Emwunyenkwu*, 31(1), 5–50.

- Kim, J.-S. (1984). Chephaysine(捷解新語)-wa kayswuchephaysine(改修捷解新語)-uy pikyoyenkwo [A comparative study of Chep-Hay-Sin-E and Kay-Swu-Chep-Hay-Sin-E]. *Yengnamemwunhak*, 11, 239–263.
- Kim, P.-H. (1964). Kwukemoumcheykyeyuy pyentongey kwanhan kochal [On the reconstruction of the vocalic system of Middle Korean]. *Tong-A Mwonhwa*, 2, 29–80.
- Kim, S. S. (2003). Santa. In J. Janhunen (Ed.), *The Mongolic languages*, Routledge Language Family Series (pp. 346–363). London: Routledge.
- Kim, W. (2005). Ceycwupangenyese [·]-umuy umhyangpwunsek [The acoustic analysis of [·] in Jeju dialect]. *Enekwahakyenkwo (Journal of Linguistic Science)*, 33, 23–36.
- Kim, W.-J. (1963). Kwuke moumcheykyeyuy sinkochal [An investigation of Korean vowel system]. *Cintanhakpo*, 24, 63–99.
- Kim, W.-J. (1978). Moumcheykyeywa moumcohwaey tayhan panseng [Reflections on the vowel system and vowel harmony of Korean]. *Language Research*, 14(2), 127–139.
- Kim, Y. S. (1977). Hwunmincengumuy “selchwuk” cacil [The feature “tongue contraction” in Hunminjeongeum]. *Eoneohag (Journal of the Linguistic Society of Korea)*, 2, 157–166.
- Kim, Y.-S. (1988). Ideophones in Korean: a nonlinear analysis. In The Linguistic Society of Korea (Ed.), *Linguistics in the morning calm 2: selected papers from SICOL-1986* (pp. 443–466). Seoul, Korea: Hanshin Publishing Company.
- Kim-Renaud, Y.-K. (1976). Semantic features in phonology: evidence from vowel harmony in Korean. *Chicago Linguistic Society*, 12, 397–412.

- Kim-Renaud, Y.-K. (1997). The phonological analysis reflected in the Korean writing system. In Y.-K. Kim-Renaud (Ed.), *The Korean alphabet: its history and structure* (pp. 161–192). Honolulu: University of Hawai'i Press.
- Kim-Renaud, Y.-K. (2008). The vowel system and vowel harmony in 15th century Korean revisited. *Proceedings of the SCRIPTA 2008: Hunminjeongeum and alphabetic writing systems* (pp. 23–36). Presented at the SCRIPTA 2008.
- Kiparsky, P. (1968). *How abstract is phonology?* Bloomington, IN: Indiana University Linguistics Club.
- Kiparsky, P. (2000). Opacity and cyclicity. *The Linguistic Review*, 17(2-4), 351–366.
- Kiparsky, P. (2003). The phonological basis of sound change. In B. D. Joseph & R. D. Janda (Eds.), *The handbook of historical linguistics* (pp. 313–342). Oxford, UK: Blackwell.
- Kirchner, M. (1998a). Kirghiz. In E. A. Csató & L. Johanson (Eds.), *The Turkic languages*, Routledge Language Family Series (pp. 344–356). London; New York: Routledge.
- Kirchner, M. (1998b). Kazakh and Karakalpak. In E. A. Csató & L. Johanson (Eds.), *The Turkic languages*, Routledge Language Family Series (pp. 318–332). London; New York: Routledge.
- Ko, D., & Yurn, G. (2011). *A description of Najkhin Nanai*. Altaic Languages Series. Seoul National University Press.
- Ko, S. (2011a). Thwungkwusuewa mongkoleuy moumcohwa tayco yenkwu [Microvariation between Tungusic and Mongolic vowel harmony]. *Altai Hakpo (Journal of the Altaic Society of Korea)*, 21, 147–179.
- Ko, S. (2011b). Vowel contrast and vowel harmony shift in the Mongolic languages. *Language Research*, 47(1), 23–43.

- Kөгjiltü, U. (1982). Monggol töröl kele-nügüd-ün ündüsün egesig-ün qaricagu-lul-un tobci agulg-a [Summary of comparison of the basic vowels in the Mongolian languages]. *Ö bör Monggol-un Yeke Surgaguli-yin Erdem Sinjilegen-ü Sedgül: Gün Uqagan Neyigem Sinjilekü Uqagan [Journal of Inner Mongolia University: Philosophy and Social Sciences]*, 1982/3, 297–304.
- Kөгjiltü, U. (1986). Shilun zhong shiji Mengguyu yuanyin e de yinzhi [Remarks on the quality of the vowel e in Middle Mongolian]. *Neimenggu daxue xuebao: zhexue shehui kexue ban [Journal of Inner Mongolia University: philosophy and social sciences]*, 1986(3), 41–47.
- Kōno, R. (1968). Chōsen kanzion no kenkyū [Study on Sino-Korean]. *Kōno Rokurō Works 2 (1979)* (pp. 295–512). Tokyo: Heibonsha.
- Konstantinova, O. A. (1964). *Evenkijskij jazyk: fonetika i morfologija*. Moscow; Leningrad: Nauka.
- Krämer, M. (2003). *Vowel harmony and correspondence theory*. Studies in generative grammar. Berlin; New York: Walter de Gruyter.
- Krueger, J. R. (1961). *Chuvash manual: introduction, grammar, reader and vocabulary*. Indiana University Publications Uralic and Altaic Series. Bloomington, IN: Indiana University.
- Krueger, J. R. (1962). *Yakut manual: area handbook, grammar, graded reader and glossary*. Indiana University Publications Uralic and Altaic Series. Bloomington, IN: Indiana University Publications.
- Krueger, J. R. (1977). *Tuvan manual*. Bloomington, IN: Indiana University Press.
- Krueger, J. R. (1978). *Materials for an Oirat-Mongolian to English Citation Dictionary*. Mongolia Society occasional papers (Vol. I-III). Bloomington, IN: Mongolia Society, Indiana University.

- Kwak, C. (2003). Hyentay kwukeuy moumcheykyewa ku pyenhwaury panghyang [The vowel system of Contemporary Korean and direction of change]. *Kwukehak*, 41, 59–91.
- Labov, W. (1994). *Principles of linguistic change: Internal factors*. Language in society (Vols. 1-3, Vol. 1). Oxford, UK; Cambridge, USA: Blackwell.
- Ladefoged, P. (1964). *A phonetic study of West African languages: an auditory-instrumental survey*. West African language monographs. Cambridge University Press.
- Ladefoged, P., & Maddieson, I. (1990). Vowels of the world's languages. *Journal of Phonetics*, 18, 93–122.
- Ladefoged, P., & Maddieson, I. (1996). *The sounds of the world's languages*. Wiley-Blackwell.
- Lebedev, V. D. (1982). *Okhotskij dialekt evenskogo jazyka [The Okhotsk dialect of Even]*. Leningrad: Nauka.
- Lee, B.-G. (1985). Moum cohwaury thukseng [Some tangible properties of vowel harmony]. *Inmwunnonchong*, 15, 3–36.
- Lee, D.-Y. (1994). Korean vowel harmony: ATR-harmony. *Hangeul*, 223, 157–199.
- Lee, H. B. (1999). Korean. *Handbook of the International Phonetic Association: a guide to the use of the International Phonetic Alphabet*. Cambridge University Press.
- Lee, I., & Ramsey, S. R. (2000). *The Korean language*. Albany, NY: SUNY Press.
- Lee, J.-S. (1992). *Phonology and sound symbolism of Korean ideophones* (Ph.D. dissertation). Indiana University, Bloomington, IN.
- Lee, K.-K. (1985). Kwuke moumcohwaury kyuchik selceng [Formulation of the vowel harmony rule in Korean]. *Chwungnamtayhakkyo inmwunkwahakyenkwaso nonmwuncip*, 12(2), 1–36.

- Lee, K.-M. (1964). Mongolian loan-words in Middle Korean. *Ural-altaische Jahrbücher*, 35, 188–197.
- Lee, K.-M. (1968). Mouncheikyeywa moumcohwa [Vowel system and vowel harmony]. *Lee Soong-Nyung paksa songswukinyemnonchong*. Ulyumwunhwasa.
- Lee, K.-M. (1972a). *Kwukesa kaysel [Outline of the history of the Korean language]* (2nd ed.). Seoul, Korea: Tower Press.
- Lee, K.-M. (1972b). *Kwuke umwunsa yenkwu [A study of the phonological history of Korean]*. Seoul, Korea: Hankwuk Mwonhwa Yenkwuso.
- Lee, K.-M. (1973). 18seykiuy mancwue pangen calyo [New materials for an eighteenth century Manchu dialect]. *Cintanhakpo*, 36, 99–132.
- Lee, K.-M. (1978). *16seyki kwukeuy yenkwu [A study of the 16th century Korean]*. Seoul, Korea: Tower Press.
- Lee, K.-M., & Ramsey, S. R. (2011). *A history of the Korean Language*. Cambridge University Press.
- Lee, P.-G. (1970). Kyengkiciyekeuy mouncheikyeywa piwenswunmounhwa [The vowel system of Kyeongki regional dialect and delabialization]. *Tong-A Mwonhwa*, 9, 151–167.
- Lee, S. N. (1940). “.”-um ko [A study of the phonetic value of “.”]. *Cintanhakpo*, 12, 1–106.
- Lee, S.-J. (1977). Nampwupangeny wenswunmounhwawa mouncheikyey [Vowel labialization and vowel system in Southern dialect of Korean]. *Kwanakemwunyenkwu*, 2, 401–420.
- Lee, S.-N. (1949). Study of vowel harmony in the Korean language. *Cintanhakpo*, 16, 7–115.



- Lee, Y. (1993). *Topics in the vowel phonology of Korean* (Ph.D. dissertation). Indiana University, Bloomington, IN.
- Lewis, M. P. (2009). *Ethnologue: languages of the world*. SIL International.
- Li, B. (1996). *Tungusic vowel harmony: description and analysis*. HIL Dissertations. Dordrecht: Holland Institute of Generative Linguistics.
- Li, G. R. (2000). *Manchu: a textbook for reading documents*. Honolulu, Hawaii: University of Hawai'i Press.
- Li, Y.-S. (2011). *A study of Dolgan*. Altaic Languages Series. Seoul National University Press.
- Li, Y.-S., Lee, H., Choi, H., Kim, G. S., Lee, D. E., & Mehmet, Ö. (2008). *A study of the Middle Chulym dialect of the Chulym language*. Altaic languages series. Seoul National University Press.
- Liljencrants, J., & Lindblom, B. (1972). Numerical Simulation of Vowel Quality Systems: The Role of Perceptual Contrast. *Language*, 48(4), 839–862. doi:10.2307/411991
- Lindau, M. (1974). The feature advanced tongue root. In E. F. K. Voeltz (Ed.), *Third annual conference on African Linguistics, 7-8 April 1972*, African Series (pp. 127–133). Presented at the Third annual conference on African Linguistics, 7-8 April 1972, Bloomington, IN: Indiana University Publications.
- Lindau, M. (1975). Features for vowels. *UCLA Working Papers in Phonetics*, 30, 1–28.
- Lindau, M. (1978). Vowel features. *Language*, 54(3), 541–563. doi:10.2307/412786
- Lindau, M. (1979). The feature expanded. *Journal of Phonetics*, 7, 163–176.
- Lindblad, V. (1990). *Neutralization in Uyghur* (Master thesis). University of Washington.

- Lindblom, B., Krull, D., & Stark, J. (1992). Use of place and manner dimensions in the SUPERB-UPSID database: some patterns of in(ter)-dependence. *Fonetik*, 1992, 39–42.
- Liu, Z. (1981). *Dongxiangyu jianzhi [Short description of Santa]*. Beijing: Minzu Chubanshe.
- Maddieson, I. (1984). *Patterns of sounds*. Cambridge: Cambridge University Press.
- Maddieson, I. (1999). In search of universals. *Proceedings of the XIVth International Congress of Phonetic Sciences (ICPhS 99)* (pp. 2521–2528). Presented at the The XIVth International Congress of Phonetic Sciences (ICPhS 99), San Francisco, CA.
- Maddieson, I., & Precoda, K. (1990). Updating UPSID. *UCLA Working Papers in Phonetics*, 74, 104–111.
- Malchukov, A. L. (1995). *Even*. Languages of the world: Materials. München; Newcastle: Lincom Europa.
- Malchukov, A. L. (2006). Yakut interference in North-Tungusic languages. In H. Boeschoten & L. Johanson (Eds.), *Turkic Languages in Contact*, *Turcologica* (pp. 122–138). Wiesbaden, Germany: Otto Harrassowitz Verlag.
- Manley, T. M. (1976). Pharyngeal expansion: its use in Sre vowels and its place in phonological theory. In P. N. Jenner, L. C. Thompson, & S. Starosta (Eds.), *Austroasiatic Studies* (Vol. Part II, pp. 833–841). University of Hawai'i Press.
- Martin, S. E. (1961). *Dagur Mongolian grammar, texts, and lexicon based on the speech of Peter Onon*. Uralic and Altaic Series. Bloomington, IN: Indiana University Publications.
- Martin, S. E. (1992). *A reference grammar of Korean : a complete guide to the grammar and history of the Korean language* (1st ed.). Rutland, VT.: Charles E. Tuttle.

- Martin, S. E. (2000). How have Korean vowels changed through time? In J. J. Ree (Ed.), *Korean Linguistics (Journal of the International Circle of Korean Linguistics)* (Vol. 10, pp. 1–60).
- McCarthy, J. J. (1983). Phonological features and morphological structure. *The interplay of phonology, morphology, and syntax* (pp. 135–161). Presented at the The 19th regional meeting of the Chicago Linguistic Society (CLS 19), Chicago, IL: Chicago Linguistic Society, University of Chicago.
- McCarthy, J. J. (2002). *A Thematic Guide to Optimality Theory*. Cambridge University Press.
- McCarthy, J. J. (2011). *Doing Optimality Theory: Applying Theory to Data*. John Wiley & Sons.
- Menges, K. H. (1968). Die tungusischen Sprachen. In B. Spuler (Ed.), *Handbuch der Orientalistik, Erste Abteilung, Fünfter Bd., Dritter Abschnitt, Tungusologie* (pp. 21–256). Leiden: Brill.
- Menges, K. H. (1978). Problems of Tungus Linguistics. *Anthropos*, 73(3/4), 367–400.
- Menz, A. (2011). The Turkic languages of Europe. In B. Kortmann & J. van der Auwera (Eds.), *The languages and linguistics of Europe: a comprehensive guide*, World of linguistics (Vol. 2). Berlin; New York: Mouton de Gruyter.
- Mester, R.-A. (1986). *Studies in tier structure* (Ph.D. dissertation). University of Massachusetts, Amherst.
- Mielke, J. (2008). *The emergence of distinctive features*. Oxford, UK: Oxford University Press.
- Miller, R. A. (1971). *Japanese and the other Altaic languages*. Chicago, IL: University of Chicago Press.

- Möömöö, S. (1977). *Sistema fonem sovremennogo mongol'skogo jazyka [The phoneme system of modern Mongolian]*. Warszawa: Wydawnictwa Uniwersytetu Warszawskiego.
- Moon, Y.-S. (1974). *A phonological history of Korean* (Ph.D. dissertation). University of Texas, Austin.
- Moseley, C. (Ed.). (2010). *Atlas of the world's languages in danger*. UNESCO Publishing.
- Naeher, C. (2004). A note on vowel harmony in Manchu. In C. Naeher, G. Stary, & M. Weiers (Eds.), *Proceedings of the First International Conference on Manchu-Tungus Studies (Bonn, August 28-September 1, 2000) Vol 2: Trends in Tungusic and Siberian linguistics*, *Tunguso Sibirica* (Vol. 2, pp. 129–136). Presented at the The First International Conference on Manchu-Tungus Studies (Bonn, August 28-September 1, 2000), Otto Harrassowitz Verlag.
- Nam, K.-W. (1974). Wenswunmoumhwahyensangey kwanhan yenkwu [A study on labialization]. *Kwukehak*, 2, 31–38.
- Nangrub. (1981). Monggol kelen-ü abiyau kögjl-ün teüke-yin tobci [Outline history of the sound development of Mongolian]. *Monggol kele udq-a jokiyal [Mongolian language and literature]*, 1981/3, 1–30.
- Nevins, A. (2010). *Locality in Vowel Harmony*. Linguistic Inquiry Monograph. MIT Press.
- Nikolaeva, I. A., & Tolskaya, M. (2001). *A grammar of Udihe*. Mouton grammar library. Berlin, Germany: Mouton de Gruyter.
- Norman, J. (1978). *A concise Manchu-English lexicon*. Publications on Asia of the School of International Studies. Seattle: University of Washington Press.
- Novikova, K. A. (1960). *Očerki dialektov Evenskogo jazyka: ol'skij govor* (Vol. 1). Leningrad: Nauka.

- Nugteren, H. (1997). On the classification of the peripheral Mongolic languages. *The historical and linguistic interaction between Inner-Asia and Europe*, Studia Uralo-Altaica (Vol. 39, pp. 207–216). Presented at the The 39th Permanent International Altaistic Conference, Szeged: University of Szeged.
- Nugteren, H. (2003). Shira Yughur. In J. Janhunen (Ed.), *The Mongolic languages*, Routledge Language Family Series (pp. 265–285). London: Routledge.
- Odden, D. (1978). Abstract vowel harmony in Manchu. *Linguistic Analysis*, 4(2), 149–165.
- Oh, K.-K. (1993). 15seki cengum mwunhene nathananun moum iphoki yenkwu [A study of misspellings in the 15th century “cengum” texts]. *Sengkyunemwunyenkwu*, 29.
- Oh, S.-S. (1998). The Korean Vowel Shift revisited. *Language Research*, 34(2), 445–463.
- Omamor, A. P. (1988). Okpe and Uvwie: a case of vowel harmony galore. *Journal of West African Languages*, 18(1), 47–64.
- Paek, D.-H. (1988). /ʌ, o, i, u/-uy taylipkwankyeywa wenswunmoumhwa [The contrastive relationship between /ʌ, o, i, u/ and labialization]. *Kwukehak*, 17, 177–202.
- Paek, D.-H. (1992). Wenswunmoumhwa “ʌ>o” hyenguy pwunphowa thongsiseng [/ʌ/ to /o/ labialization: distribution and diachrony]. *Kwukehak*, 22, 341370.
- Painter, C. (1971). Vowel harmony in Anum. *Phonetica*, 23(4), 239–248.  
doi:10.1159/000259346
- Park, C. (1986). Kwuke moumcheykyeyey tayhan han kasel [A hypothesis on the Korean vowel system]. *Kwukekwukmwunhak*, 95, 313–343.
- Park, C. (2000). Kyeylimyusa Kolyepangenuy moumcheykyey [The vowel system of Koryeo dialect in Jīlín lèishì]. *Kwukyel Yenkwu*, 6, 173–199.

- Park, H.-J. (2001). *A study on the vowel of the Middle Korean: by a side view of phonetics* (Master thesis). Ehwa Women's University, Seoul, Korea.
- Park, J.-H. (1983). *Kwuke umwunlon yenkwu [A study on Korean phonology]*. Wonkwang University Press.
- Park, J.-H. (1994). Cwunglipmoum /i/-uy poncil kwa moumcohwa [The nature of the neutral vowel /i/ and vowel harmony]. In nonchongkanhayngwiwenhoy (Ed.), *Wulimal yenkwuuy saymthe* (pp. 134–153). Daejeon, Korea: Mwunkyeng Press.
- Park, J.-H. (2000). Wenswunmoumhwa hyensanguy umwunsacek yenkwu [A historical-phonological study of vowel labialization]. *Kwukekwukmwunhak*, 126, 1–26.
- Park, J.-H. (2002). Cwungsengmoum /i/-uy thwumyengsengkwa pwulthwumyengseng [The transparency and opacity of the neutral vowel /i/ in Middle Korean]. *Hangeul*, 257, 71–101.
- Park, J.-H., & Kwon, P.-R. (2009). Moumcheykyeyuy pyenchenkwa cacilkyelhap coken [The change of vowel system and featural combination conditions in Middle Korean]. *Kwukemwunhak*, 47, 37–61.
- Park, S. (1990). Vowel harmony in Korean. *Language Research*, 26(3), 469–499.
- Parker, S. G. (2002). *Quantifying the sonority hierarchy* (Ph.D.). University of Massachusetts at Amherst, Amherst, MA.
- Paster, M. (2004). Vowel height harmony and blocking in Buchan Scots. *Phonology*, 21(03), 359–407. doi:10.1017/S0952675704000314
- Pericliev, V. (2008). Implicational phonological universals. *Folia Linguistica*, 42(1), 195–225.
- Pike, K. L. (1947). *Phonemics: a technique for reducing languages to writing*. Ann Arbor, MI: University of Michigan.

- Poppe, N. N. (1955). *Introduction to Mongolian comparative studies*. Helsinki: Suomalais-ugrilainen Seura.
- Poppe, N. N. (1960a). *Vergleichende Grammatik der altaischen Sprachen. Teil I. Vergleichende Lautlehre [Comparative grammar of the Altaic languages, Part 1: comparative phonology]*. Wiesbaden, Germany: Otto Harrassowitz.
- Poppe, N. N. (1960b). *Buriat grammar*. Bloomington, IN: Indiana University.
- Poppe, N. N. (1964). *Bashkir manual: descriptive grammar and texts with a Bashkir-English glossary*. Indiana University Publications Uralic and Altaic Series. Bloomington, IN: Indiana University.
- Poppe, N. N. (1965). *Introduction to Altaic linguistics*. Wiesbaden, Germany: Otto Harrassowitz.
- Poppe, N. N. (1968). *Tatar manual: descriptive grammar and texts with a Tatar-English glossary*. Indiana University Publications Uralic and Altaic Series ([2d rev. ed.]). Bloomington, IN: Indiana University.
- Poppe, N. N. (1970). *Mongolian language handbook*. Washington D. C.: Center for Applied Linguistics.
- Prince, A., & Smolensky, P. (2004). *Optimality Theory: Constraint interaction in generative grammar*. Blackwell.
- Pritsak, O. (1964). Das Mogholische. *Mongolistik, Handbuch der Orientalistik* (Vol. 2, pp. 159–184). Leiden: Brill.
- Przedziecki, M. A. (2005). *Vowel harmony and coarticulation in three dialects of Yoruba: phonetics determining phonology* (Ph.D. dissertation). Cornell University.
- Qasbagatur. (1986). *Tuzuyu cihui [Monguor vocabulary]*. Monggol töröl-ün kele ayalgun-u sudulul-un cuburil. Kökeqota: Ö bör Monggol-un arad-un keblel-ün qoriy-a.

- Qingge'ertai [Cenggeltei]. (1985). Guanyu Menggu yuzu yuyan ji qi yanjiu [Languages of the Mongolian group and their investigations]. *Neimenggu daxue xuebao: zhaxue shehui kexue ban [Journal of Inner Mongolia University: philosophy and social sciences]*, 1985(4), 18–28.
- Qingge'ertai [Cenggeltei]. (1991). *Tuzuyu he Mengguyu [Monguor and Mongolian]*. Monggol töröl-ün kele ayalgun-u sudulul-un cuburil. Kökeqota: Ö bör Monggol-un arad-un keblel-ün qoriy-a.
- Rákos, A. (2002). *Written Oirat*. Languages of the World/Materials. LINCOM Europa.
- Ramstedt, G. J. (1952). *Einführung in die altaische Sprachwissenschaft II: Formenlehre [Introduction to Altaic linguistics II: morphology]*. Helsinki: Suomalais-ugrilainen Seura.
- Reh, M. (1986). On the classification of vowel phonemes in Anywak. *Afrikanistische Arbeitspapiere*, 7, 5–32.
- Rice, K. (2007). Markedness in phonology. In P. V. D. Lacy (Ed.), *The Cambridge handbook of phonology* (pp. 79–98). Cambridge University Press.
- Robbek, V. A., & Robbek, M. E. (2005). *Evensko-russkij slovar' [Ewen-Russian dictionary]*. Novosibirsk: Nauka.
- Romanova, A. V., & Myreeva, A. N. (1962). *Ocherki tokkinskogo i tommotskogo govorov evenkijskogo jazyka [Sketches of the Tokkin and Tommot dialects of Ewenki]*. Moscow; Leningrad: Nauka.
- Romanova, A. V., & Myreeva, A. N. (1964). *Ocherki uchurskogo, majskogo i tottinskogo govorov evenkijskogo jazyka [Sketches of the Uchur, Mai, and Tottin dialects of Ewenki]*. Moscow; Leningrad: Nauka.
- Rose, S., & Walker, R. (2011). Harmony systems. In J. Goldsmith, J. Riggle, & A. C. L. Yu (Eds.), *The Handbook of Phonological Theory* (pp. 240–290). Wiley-



- Blackwell. Retrieved from  
<http://onlinelibrary.wiley.com/doi/10.1002/9781444343069.ch8/summary>
- Rybatzki, V. (2003a). Middle Mongol. In J. Janhunen (Ed.), *The Mongolic languages*, Routledge Language Family Series (pp. 47–82). London: Routledge.
- Rybatzki, V. (2003b). Intra-Mongolic taxonomy. In J. Janhunen (Ed.), *The Mongolic languages*, Routledge Language Family Series (pp. 364–390). London: Routledge.
- Sagey, E. C. (1986). *The representation of features and relations in non-linear phonology* (Ph.D. dissertation). Massachusetts Institute of Technology. Retrieved from <http://dspace.mit.edu/handle/1721.1/15106>
- Sanzheev, G. D. (1977). Mongolian languages. (A. M. Prokhorov, Ed.) *Great Soviet encyclopedia*. New York: Macmillan.
- Schönig, C. (1998a). South Siberian Turkic. In E. A. Csató & L. Johanson (Eds.), *The Turkic languages*, Routledge Language Family Series (pp. 403–416). London; New York: Routledge.
- Schönig, C. (1998b). Turkmen. In E. A. Csató & L. Johanson (Eds.), *The Turkic languages*, Routledge Language Family Series (pp. 261–272). London; New York: Routledge.
- Schönig, C. (1998c). Azerbaijanian. In E. A. Csató & L. Johanson (Eds.), *The Turkic languages*, Routledge Language Family Series (pp. 248–260). London; New York: Routledge.
- Sečenbayatur, Qasgerel, Tuyay-a, ĵirannige, B., & U Ying ĵe. (2005). *Mongĵul kelen-ü nutuy-un ayalĵun-u sinĵilel-ün uduridqal*. Kökeqota[Huhhot]: Öbür mongĵul-un arad-un keblel-ün qoriy-a.
- Sechenbaatar, B. (2003). *The Chakhar dialect of Mongol: a morphological description*. Helsinki: Finno-Ugrian Society.

- Sem, L. I. (1976). *Ocherki dialectov nanajnskogo jazyka*. Leningrad: Izdatel'stvo nauka leningradskoe otdelenie.
- Seong, B.-I. (1981). *A study on Manchu phonology*. Seoul, Korea: Myong-ji University Press.
- Seong, B.-I. (1999a). A study on the phonological system of Dagur Mongolian. In B.-I. Seong (Ed.), *Studies on Manchu and Altaic linguistics* (pp. 609–645). Seoul, Korea: Thaeaksa.
- Seong, B.-I. (1999b). Mancwue umwunsayenkwulul wihaye: Chengmwunkyeymong Isichengca yenkwu (kiil) [A study on some phonological changes in Manchu (Part I)]. In B.-I. Seong (Ed.), *Studies on Manchu and Altaic linguistics* (pp. 423–462). Seoul, Korea: Thaeaksa.
- Seong, B.-I. (1999c). Mancwue umwunsayenkwulul wihaye: Chengmwunkyeymong Isichengca yenkwu (kii) [A study on some phonological changes in Manchu (Part II)]. In B.-I. Seong (Ed.), *Studies on Manchu and Altaic linguistics* (pp. 463–496). Seoul, Korea: Thaeaksa.
- Seong, B.-I., Kim, J., Ko, D., & Kwon, J.-I. (2010). *Cwungkwukuy takwuluewa ewengkhieuy mwunpep ehwi yenkwu [Grammar and lexicon of Dagur and Ewenki spoken in China]*. Daewoo Academic Series. Acanet.
- Siqinchaoketu [Secencogtu]. (1999). *Kangjiayu yanjiu [Studies on Kangjia]*. Shanghai: Shanghai Yuandong.
- Sjoberg, A. F. (1962). The phonology of Standard Uzbek. In N. N. Poppe (Ed.), *American studies in Altaic linguistics*, Indiana University Publications Uralic and Altaic Series (pp. 237–261). Bloomington, IN: Indiana University Press.
- Skribnik, E. K. (2003). Buryat. In J. Janhunen (Ed.), *The Mongolic languages*, Routledge Language Family Series (pp. 102–128). London: Routledge.

- Slater, K. W. (1998). *Minhe Mangghuer: a mixed language of the inner Asian frontier* (Ph.D. dissertation). University of California, Santa Barbara, Santa Barbara, CA.
- Slater, K. W. (2003a). Mangghuer. In J. Janhunen (Ed.), *The Mongolic languages*, Routledge Language Family Series (pp. 307–324). London: Routledge.
- Slater, K. W. (2003b). *A grammar of Mangghuer: a Mongolic language of China's Qinghai-Gansu Sprachbund*. Psychology Press.
- Sohn, H. (1999). *The Korean language*. Cambridge University Press.
- Sohn, H.-S. (1987). *Underspecification in Korean phonology (morphology)* (Ph.D. dissertation). University of Illinois at Urbana-Champaign, Urbana-Champaign, IL.
- Song, J.-M. (1999). Cwungseykwuke moumcohwa [Middle Korean vowel harmony within government phonology]. *Eoneohag (Journal of the Linguistic Society of Korea)*, 25, 137–165.
- Stachowski, M., & Menz, A. (1998). Yakut. In E. A. Csató & L. Johanson (Eds.), *The Turkic languages*, Routledge Language Family Series (pp. 417–433). London; New York: Routledge.
- Starostin, S. A., Dybo, A. V., & Mudrak, O. A. (2003). *An etymological dictionary of Altaic languages* (Vols. 1-3). Leiden: Brill Academic Publishers.
- Starwalt, C. G. A. (2008, July). *The acoustic correlates of ATR harmony in seven- and nine-vowel African languages: a phonetic inquiry into phonological structure* (Ph.D. dissertation). University of Texas, Arlington. Retrieved from <https://dspace.uta.edu/handle/10106/1015?show=full>
- Steriade, D. (1987). Redundant values. In A. Bosch, B. Need, & E. Schiller (Eds.), *Parasession on Autosegmental and Metrical Phonology* (Vol. 23(2), pp. 339–

- 362). Presented at the The 23rd Annual Meeting of the Chicago Linguistics Society (CLS 23), Chicago, IL: University of Chicago.
- Steriade, D. (1995). Underspecification and markedness. In J. A. Goldsmith (Ed.), *The handbook of phonological theory* (pp. 114–174). Oxford: Blackwell.
- Stevens, K. N., Keyser, S. J., & Kawasaki, H. (1986). Toward a phonetic and phonological theory of redundant features. In J. S. Perkell & D. H. Klatt (Eds.), *Symposium on invariance and variability in speech processes* (Vol. xxiii, pp. 432–469). Hillsdale, NJ: Lawrence Erlbaum.
- Stewart, J. M. (1967). Tongue Root Position in Akan Vowel Harmony. *Phonetica*, 16, 185–204. doi:10.1159/000258568
- Sun, Z., Zhaonasitu, Chen, N., Wu, J., & Li, K. (1990). *Menggu yuzu yuyan cidian*. Qīnghǎi rénmin chūbǎnshè.
- Sunik, O. (1959). Tunguso-man'chzhurskie jazyki. *Mlado-pis'mennye jazyki narodov SSSR* (pp. 318–351). Moscow; Leningrad: Izdatel'stvo Akademii nauk SSSR.
- Sunik, O. (1985). *Ul'chskij jazyk: issledovaniya i materialy*. Leningrad: Nauka.
- Suomi, K. (1983). Palatal vowel harmony: a perceptually motivated phenomenon? *Nordic Journal of Linguistics*, 6(01), 1–35. doi:10.1017/S0332586500000949
- Svantesson, J.-O. (1985). Vowel harmony shift in Mongolian. *Lingua*, 67(4), 283–327. doi:10.1016/0024-3841(85)90002-6
- Svantesson, J.-O. (1995). Phonetic evidence for the great Mongolian vowel shift. *Proceedings of the XIIIth International Congress of Phonetic Sciences (ICPhS 95)* (Vol. 1, pp. 416–419). Presented at the The XIIIth International Congress of Phonetic Sciences (ICPhS 95), Stockholm, Sweden: KTH/Stockholm University.
- Svantesson, J.-O. (2000). Mongolic vowel shifts and the classification of the Mongolic languages. *Altai Hakpo (Journal of the Altaic Society of Korea)*, 10, 193–207.

- Svantesson, J.-O. (2003). Khalkha. In J. Janhunen (Ed.), *The Mongolic languages*, Routledge Language Family Series (pp. 154–176). London: Routledge.
- Svantesson, J.-O. (2004). What happens to Mongolian vowel harmony? In A. Csirmaz, Y. Lee, & M. A. Walter (Eds.), *Proceedings of the 1st Workshop on Altaic Formal Linguistics (WAFL 1)*, MIT Working Papers in Linguistics (Vol. 46, pp. 94–106). Cambridge, MA: MITWPL.
- Svantesson, J.-O., Tsendina, A., Karlsson, A. M., & Franzén, V. (2005). *The phonology of Mongolian*. Oxford, UK: Oxford University Press.
- Thurgood, G., & LaPolla, R. J. (Eds.). (2003). *The Sino-Tibetan languages*. Routledge language family series. London: Routledge.
- Tiede, M. K. (1996). An MRI-based study of pharyngeal volume contrasts in Akan and English. *Journal of Phonetics*, 24, 399–421.
- Tolskaya, I. K. (2008, April 1). *Oroch vowel harmony* (Master thesis). University of Tromsø. Retrieved from <http://munin.uit.no/munin/handle/10037/1404>
- Trubetzkoy, N. S. (1969). *Principles of phonology (Grundzüge der Phonologie)*. (C. A. M. Baltaxe, Trans.). Berkeley; Los Angeles: University of California Press.
- Tsumagari, T. (2003). Dagur. In J. Janhunen (Ed.), *The Mongolic languages*, Routledge Language Family Series (pp. 129–153). London: Routledge.
- Tsumagari, T. (2009a). Grammatical outline of Uilta (revised). *Journal of the Graduate School of Letters, Graduate School of Letters, Hokkaido University*, 4, 1–21.
- Tsumagari, T. (2009b). A sketch of Solon grammar. *Journal of the Center for Northern Humanities, Hokkaido University*, 2, 1–21.
- Tsumagari, T. (2010). Remarks on Udihe phonology: from an areal-typological perspective. In Hokkaido Daigaku Daigakuin Bungakukenyuuka

- Gengojoohogaku-kooza (Ed.), *Gengokenkyu no shoso* (pp. 103–112).  
Sapporo: Hokkaido University Press.
- Tsumagari, T. (2011). An Udihe folktale text: “Solomo and Tausima.” *Journal of the Center for Northern Humanities, Hokkaido University*, 4, 75–93.
- Unger, J. M. (2009). Some remarks on Hankul transcriptions of Middle Japanese. *SCRIPTA (International Journal of Writing Systems)*, 1, 77–87.
- Vago, Robert M. (1973). Abstract Vowel Harmony Systems in Uralic and Altaic Languages. *Language*, 49(3), 579–605. doi:10.2307/412352
- Vajda, E. J. (1994). Kazakh phonology. In E. H. Kaplan, D. W. Whisenhunt, & H. G. Schwarz (Eds.), *Opuscula Altaica: essays presented in honor of Henry Schwarz*, Studies on East Asia (pp. 603–650). Western Washington.
- Vajda, E. J. (2009). The languages of Siberia. *Language and Linguistics Compass*, 3(1), 424–440. doi:10.1111/j.1749-818X.2008.00110.x
- van der Hulst, H., & Smith, N. (1988). Tungusic and Mongolian vowel harmony: a minimal pair. *Linguistics in the Netherlands* (pp. 79–88). Dordrecht: Foris.
- van der Hulst, H., & van de Weijer, J. (1995). Vowel harmony. In J. A. Goldsmith (Ed.), *The handbook of phonological theory* (pp. 495–534). Oxford: Blackwell.
- Vasilevich, G. M. (1940). *Ocherk grammatiki evenkijskogo (tungusskogo) jazyka [A grammatical sketch of the Ewenki (Tungus) language]*. Leningrad: Uchpedgiz.
- Vasilevich, G. M. (1948). *Ocherki dialektov evenkijskogo (tungusskogo) jazyka [Sketches of Ewenki (Tungus) dialects]*. Leningrad: Uchpedgiz.
- Vasilevich, G. M. (1958). *Evenkijsko-russkij slovar' [Ewenki-Russian dictionary]*. Moscow: Gosudarstvennoe izd. inostrannykh natsional'nykh slovarej.
- Vasilevich, G. M. (1960). K voprosu o klassifikacii tunguso-man'chzhurskikh jazykov [On the classification of the Tungus-Manchu languages]. *Voprosy jazykoznanija*, 2, 43–49.

- Vaux, B. (1996). The Status of ATR in Feature Geometry. *Linguistic Inquiry*, 27(1), 175–182.
- Vaux, B. (2000). Disharmony and derived transparency in Uyghur vowel harmony. In M. Hirotani, A. Coetzee, N. Hall, & J.-Y. Kim (Eds.), *Proceedings of the 30th annual meeting of North East Linguistic Society (NELS 30)* (Vol. 30, pp. 671–698).
- Vaux, B. (2009). [atr] and [back] harmony in the Altaic languages. In S. Tatevosov (Ed.), *Investigations into formal Altaic linguistics: Proceedings of WAFL 3* (pp. 50–67). Moscow: MAKS Press.
- Verhoeven, E. (2011). *Vowel harmony and noun inflection in Caucasian Urum*. Unpublished manuscript, University of Bremen. Retrieved from <http://projects.turkmas.uoa.gr/urum/bharmony.html>
- Vladimircov, B. J. (1929). *Sravnitel'naja grammatika mongol'skogo pis'mennogo jazyka i halhaskogo narečija: vvedenie i fonetika [Comparative grammar of Written Mongolian and the Halh dialect: introduction and phonetics]*. Leningrad: Izd. Leningradskogo vostočnogo instituta imeni A.S. Enukidze.
- von der Gabelentz, H. C. (1833). *Éléments de la grammaire manchoue*. Altenburg.
- Vovin, A. (1993). Towards a new classification of Tungusic languages. *Ural-altaische Jahrbücher*, 65, 99–113.
- Vovin, A. (1994). On accent in Chuvash. In Howard I. Aronson (Ed.), *NSL.7: Linguistic studies in the non-Slavic languages of the commonwealth of independent states and the Baltic republics*. Chicago, IL: Chicago Linguistic Society.
- Vovin, A. (2000). On the Great Vowel Shift in Middle Korean and position of stress in Proto-Korean. In J. J. Ree (Ed.), *Korean Linguistics (Journal of the International Circle of Korean Linguistics)* (Vol. 10, pp. 61–78).

- Vovin, A. (2005). The end of the Altaic controversy. *Central Asiatic journal*, 49(1), 71–132.
- Walker, R. (1993). A vowel feature hierarchy for contrastive specification. (C. Dyck, Ed.) *Toronto Working Papers in Linguistics*, 12(2), 179–197.
- Walker, R. (2001). Round licensing, harmony, and bisyllabic triggers in Altaic. *Natural Language & Linguistic Theory*, 19(4), 827–878.  
doi:10.1023/A:1013349100242
- Walker, R. (2005). Weak triggers in vowel harmony. *Natural Language & Linguistic Theory*, 23(4), 917–989. doi:10.1007/s11049-004-4562-z
- Weiers, M. (1972). *Die Sprache der Moghol der Provinz Herat in Afghanistan (Sprachmaterial, Grammatik, Wortliste)*. Opladen: Westdeutscher Verlag.
- Weiers, M. (2003). Moghol. In J. Janhunen (Ed.), *The Mongolic languages*, Routledge Language Family Series (pp. 248–264). London: Routledge.
- Whaley, L. J., Grenoble, L. A., & Li, F. (1999). Revisiting Tungusic classification from the bottom up: a comparison of Evenki and Oroqen. *Language*, 75(2), 286–321.
- Whitman, J. (2011). Northeast Asian linguistic ecology and the advent of rice agriculture in Korea and Japan. *Rice*, 4(3), 149–158. doi:10.1007/s12284-011-9080-0
- Wood, S. A. J. (1975). The weaknesses of the tongue arching model of vowel articulation. *Working papers, Phonetics Laboratory, Department of General Linguistics, Lund University*, 11, 55–107.
- Wood, S. A. J. (1979). A radiographic analysis of constriction locations for vowels. *Journal of Phonetics*, 7, 25–43.
- Yang, J. (2010). *An acoustic analysis of Ewenki vowels* (Master thesis). Seoul National University, Seoul, Korea.



- Yilinzhen [Ircin, Yekemingadai]. (1976). *Weiwuti Mengwen he gu Mengguyu yuyin* [Uyghur Mongolian script and Old Mongolian speech sounds]. *Neimenggu daxue xuebao: zhexue shehui kexue ban* [Journal of Inner Mongolia University: philosophy and social sciences], Monggol töröl-ün kele ayalgun-u sudulul-un cuburil, 1976/2; 1977/2; 1978/1, 69–76; 70–72; 65–73.
- Yu, W. (2011). *A Study of the Mongol Khamnigan Spoken in Northeastern Mongolia*. Altaic Languages Series. Seoul National University Press.
- Yu, W., Kwon, J.-I., Shin, Y., Choi, M.-J., Borjigin, B., & Bold, L. (2008). *A study of the Tacheng dialect of the Dagur language*. Altaic languages series. Seoul National University Press.
- Zhang, X. (1995). Vowel harmony in Oroqen (Tungus). *Toronto Working Papers in Linguistics*, 14, 161–174.
- Zhang, X. (1996). *Vowel Systems of the Manchu-Tungus Languages of China* (Ph.D. dissertation). University of Toronto.
- Zhang, X., & Drescher, B. E. (2004). Tongue root harmony in Written Manchu. In C. Naeher, G. Stary, & M. Weiers (Eds.), *Proceedings of the First International Conference on Manchu-Tungus Studies (Bonn, August 28-September 1, 2000) Vol 2: Trends in Tungusic and Siberian linguistics*, *Tunguso Sibirica* (Vol. 2, pp. 161–190). Presented at the The First International Conference on Manchu-Tungus Studies (Bonn, August 28-September 1, 2000), Otto Harrassowitz Verlag.
- Zhang, Y., Zhang, X., & Shuyan, D. (1989). *The Hezhen language*. Changchun, China: Jilin University Press.